

Industrial Automation Headquarters

Delta Electronics, Inc.
Taoyuan Technology Center
No.18, Xinglong Rd., Taoyuan District,
Taoyuan City 33068, Taiwan
TEL: 886-3-362-6301 / FAX: 886-3-371-6301

Asia

Delta Electronics (Shanghai) Co., Ltd.
No.182 Minyu Rd., Pudong Shanghai, P.R.C.
Post code : 201209
TEL: 86-21-6872-3988 / FAX: 86-21-6872-3996
Customer Service: 400-820-9595

Delta Electronics (Japan), Inc.
Tokyo Office
Industrial Automation Sales Department
2-1-14 Shibadaimon, Minato-ku
Tokyo, Japan 105-0012
TEL: 81-3-5733-1155 / FAX: 81-3-5733-1255

Delta Electronics (Korea), Inc.
Seoul Office
1511, 219, Gasan Digital 1-Ro., Geumcheon-gu,
Seoul, 08501 South Korea
TEL: 82-2-515-5305 / FAX: 82-2-515-5302

Delta Energy Systems (Singapore) Pte Ltd.
4 Kaki Bukit Avenue 1, #05-04, Singapore 417939
TEL: 65-6747-5155 / FAX: 65-6744-9228

Delta Electronics (India) Pvt. Ltd.
Plot No.43, Sector 35, HSIDC Gurgaon,
PIN 122001, Haryana, India
TEL: 91-124-4874900 / FAX : 91-124-4874945

Delta Electronics (Thailand) PCL.
909 Soi 9, Moo 4, Bangpoo Industrial Estate (E.P.Z),
Pattana 1 Rd., T.Phraksa, A.Muang,
Samutprakarn 10280, Thailand
TEL: 66-2709-2800 / FAX : 662-709-2827

Delta Energy Systems (Australia) Pty Ltd.
Unit 20-21/45 Normanby Rd., Notting Hill Vic 3168, Australia
TEL: 61-3-9543-3720

Americas

Delta Electronics (Americas) Ltd.
Raleigh Office
P.O. Box 12173, 5101 Davis Drive,
Research Triangle Park, NC 27709, U.S.A.
TEL: 1-919-767-3813 / FAX: 1-919-767-3969

Delta Greentech (Brasil) S/A
São Paulo Office
Rua Itapeva, 26 – 3º Andar - Bela Vista
CEP: 01332-000 – São Paulo – SP - Brasil
TEL: 55-11-3530-8642 / 55-11-3530-8640

Delta Electronics International Mexico S.A. de C.V.
Mexico Office
Vía Dr. Gustavo Baz No. 2160, Colonia La Loma,
54060 Tlalnepanitla Estado de Mexico
TEL: 52-55-2628-3015 #3050/3052

EMEA

Headquarters: Delta Electronics (Netherlands) B.V.
Sales: Sales.IA.EMEA@deltaww.com
Marketing: Marketing.IA.EMEA@deltaww.com
Technical Support: iatechnicalsupport@deltaww.com
Customer Support: Customer-Support@deltaww.com
Service: Service.IA.emea@deltaww.com
TEL: +31(0)40 800 3800

BENELUX: Delta Electronics (Netherlands) B.V.
De Witbogt 20, 5652 AG Eindhoven, The Netherlands
Mail: Sales.IA.Benelux@deltaww.com
TEL: +31(0)40 800 3800

DACH: Delta Electronics (Netherlands) B.V.
Coesterweg 45, D-59494 Soest, Germany
Mail: Sales.IA.DACH@deltaww.com
TEL: +49(0)2921 987 0

France: Delta Electronics (France) S.A.
ZI du bois Challand 2, 15 rue des Pyrénées,
Lisses, 91090 Evry Cedex, France
Mail: Sales.IA.FR@deltaww.com
TEL: +33(0)1 69 77 82 60

Iberia: Delta Electronics Solutions (Spain) S.L.U
Ctra. De Villaverde a Vallecas, 265 1º Dcha Ed.
Hormigueras – P.I. de Vallecas 28031 Madrid
TEL: +34(0)91 223 74 20
C/Llull, 321-329 (Edifici CINC) | 22@Barcelona, 08019 Barcelona
Mail: Sales.IA.Iberia@deltaww.com
TEL: +34 93 303 00 60

Italy: Delta Electronics (Italy) S.r.l.
Ufficio di Milano Via Senigallia 18/2 20161 Milano (MI)
Piazza Grazioli 18 00186 Roma Italy
Mail: Sales.IA.Italy@deltaww.com
TEL: +39 02 64672538

Russia: Delta Energy System LLC
Vereyskaya Plaza II, office 112 Vereyskaya str.
17 121357 Moscow Russia
Mail: Sales.IA.RU@deltaww.com
TEL: +7 495 644 3240

Turkey: Delta Greentech Elektronik San. Ltd. Sti. (Turkey)
Şerifali Mah. Hendem Cad. Kule Sok. No:16-A
34775 Ümraniye – Istanbul
Mail: Sales.IA.Turkey@deltaww.com
TEL: + 90 216 499 9910

GCC: Delta Energy Systems AG (Dubai BR)
P.O. Box 185668, Gate 7, 3rd Floor, Hamarain Centre
Dubai, United Arab Emirates
Mail: Sales.IA.MEA@deltaww.com
TEL: +971(0)4 2690148

Egypt + North Africa: Delta Electronics
511 Cairo Business Plaza, North 90 street,
New Cairo, Cairo, Egypt
Mail: Sales.IA.MEA@deltaww.com

Delta Basic Compact Drive - ME300 Series User Manual



Delta Basic Compact Drive ME300 Series User Manual



Copyright notice

©Delta Electronics, Inc. All rights reserved.

All information contained in this user manual is the exclusive property of Delta Electronics Inc.

(hereinafter referred to as "Delta ") and is protected by copyright law and all other laws. Delta retains the exclusive rights of this user manual in accordance with the copyright law and all other laws. No parts in this manual may be reproduced, transmitted, transcribed, translated or used in any other ways without the prior consent of Delta.

Limitation of Liability

The contents of this user manual are only for the use of the AC motor drives manufactured by Delta. Except as defined in special mandatory laws, Delta provides this user manual "as is" and does not offer any kind of warranty through this user manual for using the product, either express or implied, including but not limited to the following: (i) this product will meet your needs or expectations; (ii) the information contained in the product is current and correct; (iii) the product does not infringe any rights of any other person. You shall bear your own risk to use this product.

In no event shall Delta, its subsidiaries, affiliates, managers, employees, agents, partners and licensors be liable for any direct, indirect, incidental, special, derivative or consequential damages (including but not limited to the damages for loss of profits, goodwill, use or other intangible losses) unless the laws contains special mandatory provisions to the contrary.

Delta reserves the right to make changes to the user manual and the products described in the user manual without prior notice and afterwards.

PLEASE READ PRIOR TO INSTALLATION FOR SAFETY.



- ☑ Disconnect AC input power before connecting any wiring to the AC motor drive.
- ☑ Even if the power has been turned off, a charge may still remain in the DC-link capacitors with hazardous voltages before the POWER LED is OFF. Do not touch the internal circuits and components.
- ☑ There are highly sensitive MOS components on the printed circuit boards. These components are especially sensitive to static electricity. Take anti-static measures before touching these components or the circuit boards.
- ☑ Never modify the internal components or wiring.
- ☑ Ground the AC motor drive by using the ground terminal. The grounding method must comply with the laws of the country where the AC motor drive is to be installed.
- ☑ DO NOT install the AC motor drive in a location with high temperature, direct sunlight or inflammable materials or gases.



- ☑ Never connect the AC motor drive output terminals U/T1, V/T2 and W/T3 directly to the AC mains circuit power supply.
- ☑ The rated voltage of power system to install motor drives is listed below. Ensure that the installation voltage is in the correct range when installing a motor drive.
For 115V models, the range is between 85–132 V.
For 230V models, the range is between 170–264 V.
For 460V models, the range is between 323–528 V.

- ☑ Refer to the table below for short circuit rating:

Model (Power)	Short circuit rating
115V	5 kA
230V	5 kA
460V	5 kA

- ☑ Only qualified persons are allowed to install, wire and maintain the AC motor drives.
- ☑ Even if the three-phase AC motor is stopped, a charge with hazardous voltages may still remain in the main circuit terminals of the AC motor drive.
- ☑ If you store the AC motor drive in a not-charged condition for more than three months, the ambient temperature should not be higher than 30°C. Storage longer than one year is not recommended and could result in the degradation of the electrolytic capacitors.
- ☑ Pay attention to the following when transporting and installing this package (including wooden crate, wood stave and carton box).
 - 1 If you need to sterilize or deworm the wooden crate or carton box, do not use steamed sterilization or you will damage the VFD. Use other methods to sterilize or deworm.
 - 2 You may use high temperatures to sterilize or deworm. Leave the packaging materials in an environment of over 56°C for thirty minutes.

- ☑ Connect the drive to a three-phase three-wire or three-phase four-wire Wye system to comply with UL standards.
- ☑ If the drive generates leakage current over AC 3.5 mA or DC 10 mA on a grounding conductor, compliance with local grounding regulations or IEC61800-5-1 standard is the minimum requirement for grounding.

 **NOTE**

- In the pictures in this manual, the cover or safety shield is disassembled only when explaining the details of the product. During operation, install the top cover and wiring correctly according to the provisions. Refer to the operation descriptions in the manual to ensure safety.
- The figures in this instruction are only for reference and may be slightly different depending on your model, but it will not affect your customer rights.
- The content of this manual may be revised without prior notice. Consult our distributors or download the latest version at
<http://www.deltaww.com/services/DownloadCenter2.aspx?secID=8&pid=2&tid=0&CID=06&itemID=060101&TypeID=1&downloadID=&title=&dataType=&check=0&hl=en-US>

Table of Contents

CHAPTER 1 INTRODUCTION	1-1
1-1 Nameplate Information.....	1-2
1-2 Model Name.....	1-3
1-3 Serial Number.....	1-3
1-4 Apply After Service by Mobile Device.....	1-4
1-5 RFI Jumper.....	1-5
CHAPTER 2 DIMENSIONS..	2-1
Frame A.....	2-1
Frame B.....	2-2
Frame C.....	2-3
Frame D.....	2-4
CHAPTER 3 INSTALLATION.....	3-1
CHAPTER 4 WIRING	4-1
4-1 System Wiring Diagram	4-3
4-2 Wiring.....	4-4
CHAPTER 5 MAIN CIRCUIT TERMINALS	5-1
5-1 Main Circuit Diagram.....	5-4
5-2 Main Circuit Terminals.....	5-5
Frame A.....	5-6
Frame B.....	5-7
Frame C.....	5-8
Frame D.....	5-9
CHPATER 6 CONTROL TERMINALS	6-1
CHAPTER 7 OPTIONAL ACCESSORIES.....	7-1
7-1 All Brake Resistors and Brake Units Used in AC Motor Drives.....	7-2
7-2 Non-fuse Circuit Breaker.....	7-5
7-3 Fuse Specification Chart	7-7
7-4 AC/DC Reactor.....	7-9
7-5 Zero Phase Reactors.....	7-30
7-6 EMC Filter.....	7-33
7-7 EMC Shield Plate.....	7-36
7-8 Capacitive Filter.....	7-39
7-9 Conduit Box.....	7-41
7-10 Fan Kit.....	7-48

7-11	DIN-Rail Mounting.....	7-49
7-12	Mounting Adapter Plate	7-51
7-13	Digital Keypad–KPC-CC01, KPC-CE01.....	7-56
CHAPTER 8 OPTION CARD.....		8-1
8-1	Option Card Installation.....	8-2
8-2	EMM-PG01L -- STO Card, Safe Torque Off.....	8-3
CHAPTER 9 SPECIFICATION		9-1
9-1	115V Series.....	9-2
9-2	230V Series.....	9-3
9-3	460V Series.....	9-5
9-4	General Specifications.....	9-6
9-5	Environment for Operation, Storage and Transportation.....	9-7
9-6	Derating for Ambient Temperature and Altitude.....	9-8
CHAPTER 10 DIGITAL KEYPAD		10-1
CHAPTER 11 SUMMARPY OF PARAMETERS SETTINGS.....		11-1
CHAPTER 12 DESCRIPTION OF PARAMETER SETTINGS		12-00-1
12-1	Description of Parameter Settings.....	12-00-1
00	Drive Parameters.....	12.1-00-1
01	Basic Parameters.....	12.1-01-1
02	Digital Input / Output Parameters.....	12.1-02-1
03	Analog Input / Output Parameters.....	12.1-03-1
04	Multi-Stage Speed Parameters.....	12.1-04-1
05	Motor Parameters.....	12.1-05-1
06	Protection Parameters (1)	12.1-06-1
07	Special Parameters.....	12.1-07-1
08	High-function PID Parameters.....	12.1-08-1
09	Communication Parameters.....	12.1-09-1
10	Speed Feedback Control Parameters.....	12.1-10-1
11	Advanced Parameters.....	12.1-11-1
12	Function Parameters.....	12.1-12-1
13	Macro / User-Defined Macro.....	12.1-13-1
14	Protection Parameters (2)	12.1-14-1
12-2	Adjustment & Application.....	12.2-1
CHAPTER 13 WARNING CODES.....		13-1
CHAPTER 14 ERROR CODES.....		14-1

CHAPTER 15 SAFE TORQUE OFF FUNCTION.....	15-1
15-1 Basic Function Description.....	15-2
15-2 Safe Torque Off Terminal Function Description.....	15-3
15-3 Wiring Diagram.....	15-4
15-4 Failure Rate of the Drive Safety Function.....	15-5
15-5 Reset the Parameter Settings.....	15-5
15-6 Timing Diagram Description.....	15-6
15-7 Error Code and Troubleshooting Instructions.....	15-9
15-8 Test and Fault Confirmation.....	15-11

Issued Edition: 01

Firmware Version: V1.XX (Refer to Parameter 00-06 on the product to get the firmware version.)

Issued Date: 2018/11

Chapter 1 Introduction

- 1-1 Nameplate Information
- 1-2 Model Name
- 1-3 Serial Number
- 1-4 Apply After Service by Mobile Device
- 1-5 RFI Jumper

After receiving the AC motor drive, check for the following:

1. Inspect the unit after unpacking to ensure that it was not damaged during shipment. Make sure that the part number printed on the package corresponds with the part number indicated on the nameplate.
2. Make sure that the mains voltage is within the range indicated on the nameplate. Install the AC motor drive according to this manual.
3. Before applying power, make sure that all devices, including mains power, motor, control board, and digital keypad, are connected correctly.
4. When wiring the AC motor drive, make sure that the wiring of input terminals "R/L1, S/L2, T/L3", and output terminals "U/T1, V/T2, W/T3" are correct to prevent damage to the drive.
5. When power is applied, select the language and set values for parameters with the digital keypad. When executing a trial run, begin with a low speed and then gradually increase the speed until the desired speed is reached.

1-1 Nameplate Information

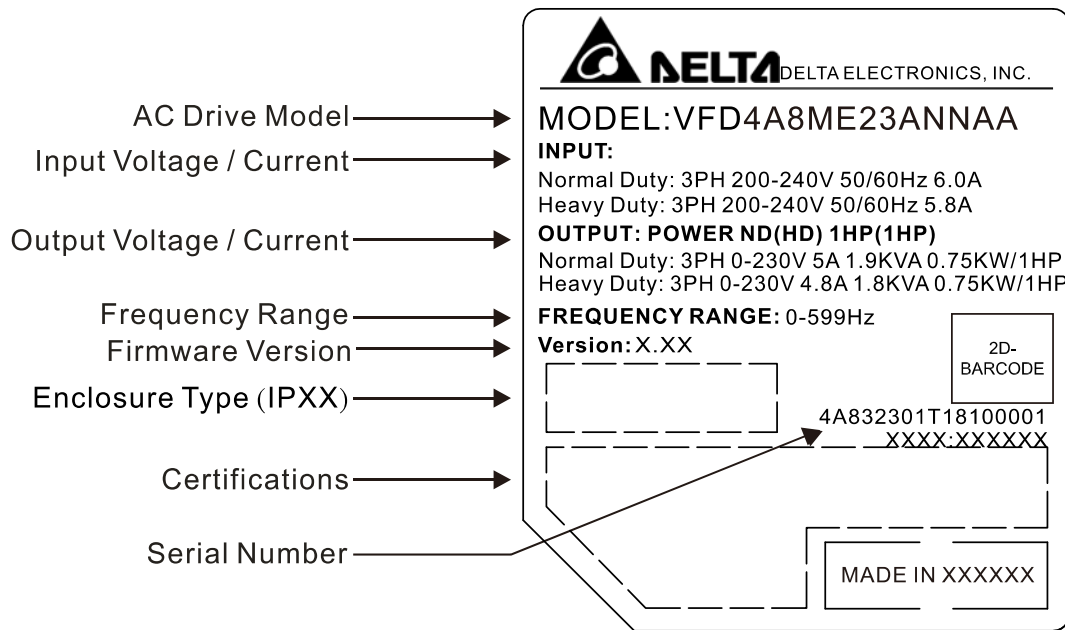

1-2 Model Name

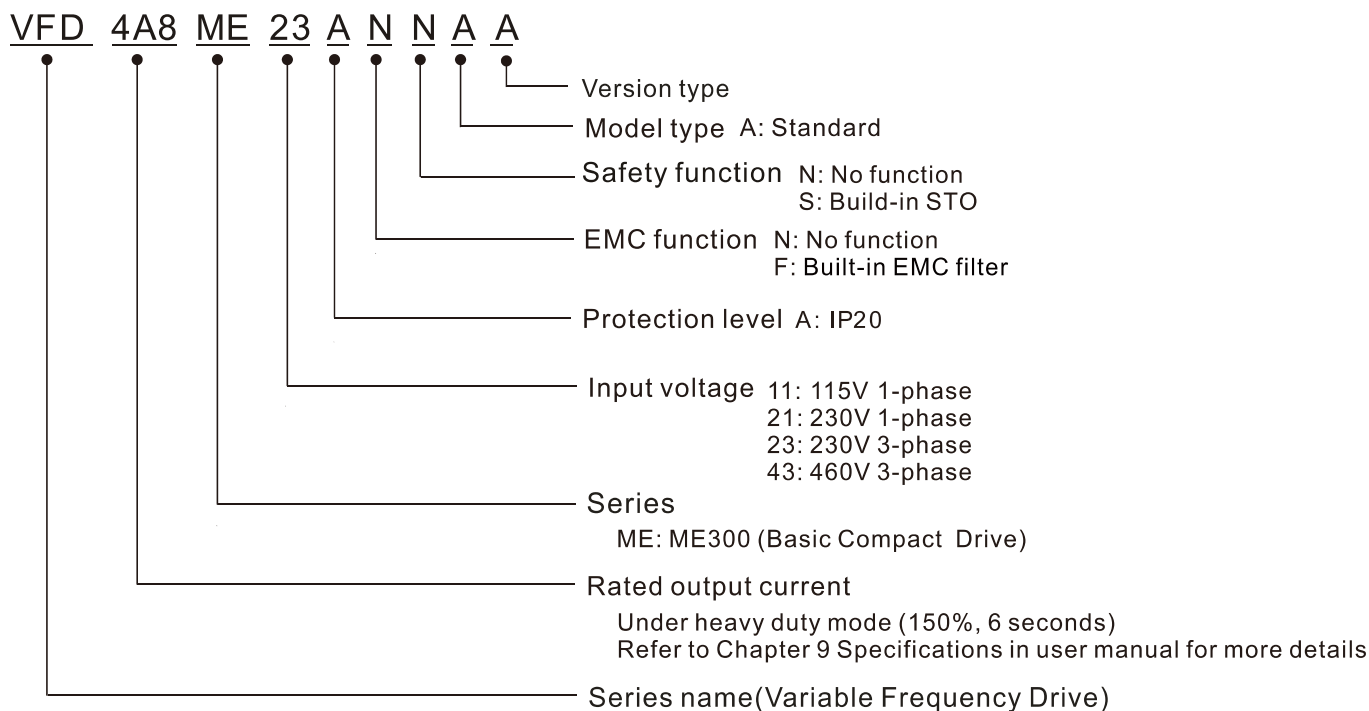

1-3 Serial Number

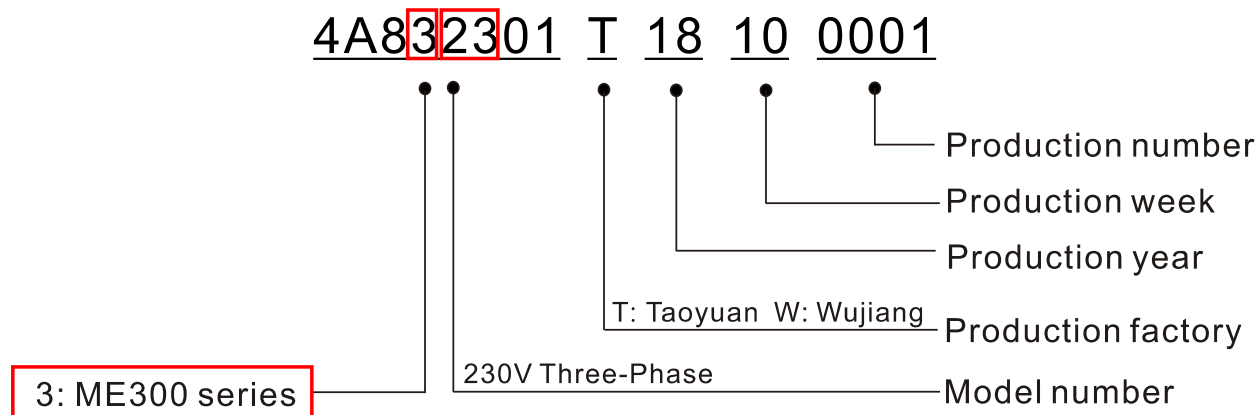

1-4 Apply After Service by Mobile Device

1-4-1 Location of Service Link Label

The service link label (Service Label) is pasted on the keypad area on the case body, as shown below.

Frame A, B

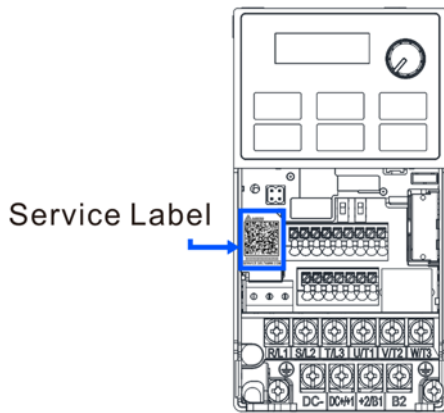

Frame C, D

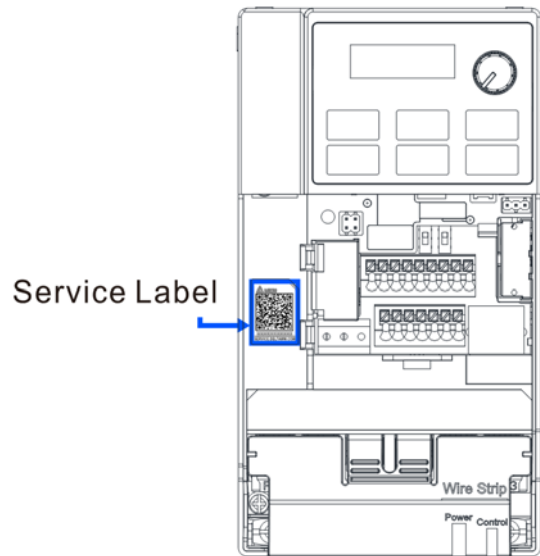

1-4-2 Service Link Label

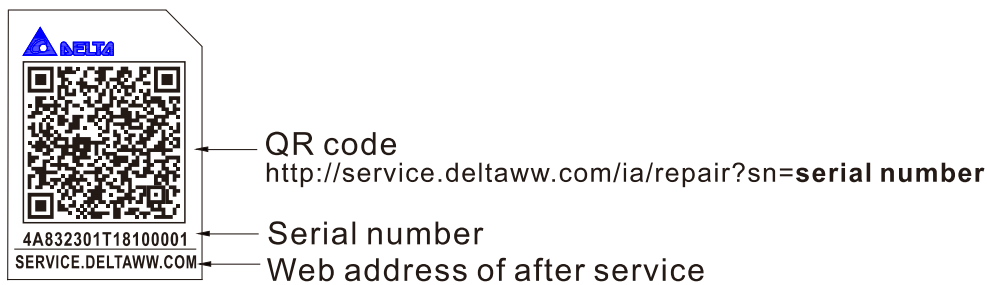

Scan QR Code to apply for service

1. Locate the QR code sticker (as shown above).
2. Use a smartphone to run a QR Code reader App.
3. Point your camera at the QR Code. Hold your camera steady so that the QR code comes into focus.
4. Access the Delta After Service website.
5. Enter your information in the column marked with an orange star.
6. Enter the CAPTCHA and click **Submit** to complete the application.

Cannot find out the QR Code?

1. Open a web browser on your computer or smartphone.
2. In the browser address bar, enter <https://service.deltaww.com/ia/repair> and press **Enter**.
3. Enter your information in the columns marked with an orange star.
4. Enter the CAPTCHA and click **Submit** to complete the application.

1-5 RFI Jumper

The drive contains Varistors/MOVs that are connected from phase to phase and from phase to ground to protect the drive against mains surges or voltage spikes.

Because the Varistors/MOVs from phase to ground are connected to ground with the RFI jumper, removing the RFI jumper disables the protection.

- (1) In models with a built-in EMC filter, the RFI jumper connects the filter capacitors to ground to form a return path for high frequency noise. This isolates the noise from contaminating the mains power. Removing the RFI jumper strongly reduces the effect of the built-in EMC filter.
- (2) Although a single drive complies with the international standards for leakage current, an installation with several drives with built-in EMC filters can trigger the RCD. Removing the RFI jumper can help, but the EMC performance of each drive is no longer guaranteed.

Frame A–D Screw Torque: 4–6 kg-cm / [3.5–5.2 lb-in.] / [0.39–0.59 Nm]

Loosen the screw and remove the RFI jumper (as shown below). Fasten the screw again after you remove the RFI jumper.

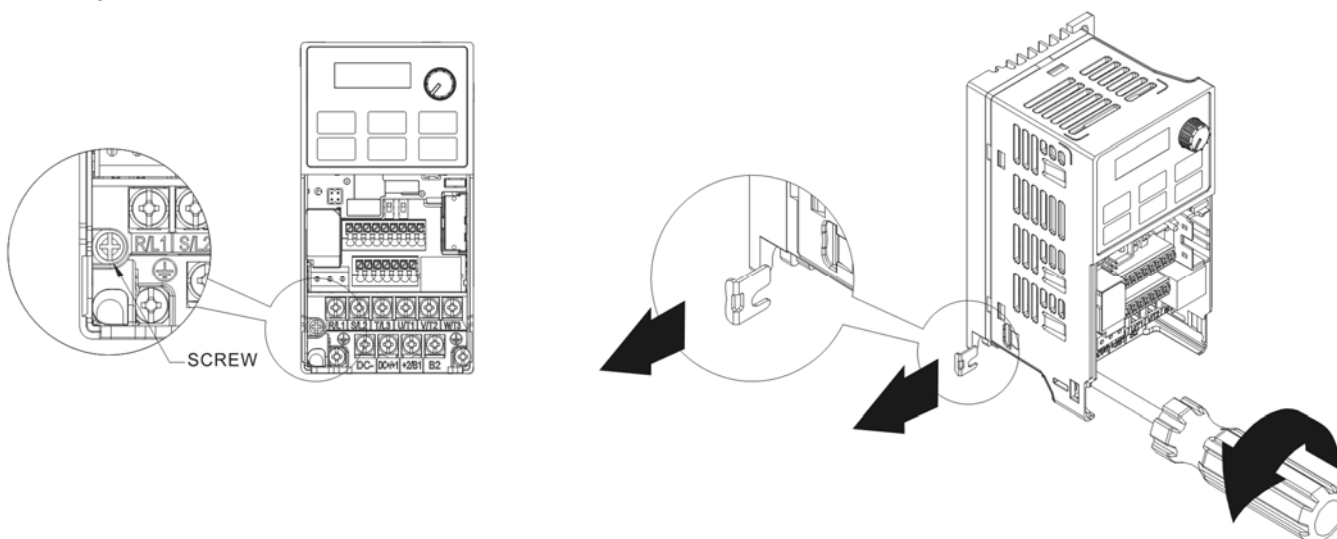

Frame B–D (model with built-in EMC filter)

Remove the RFI jumper with a screwdriver (as shown below).

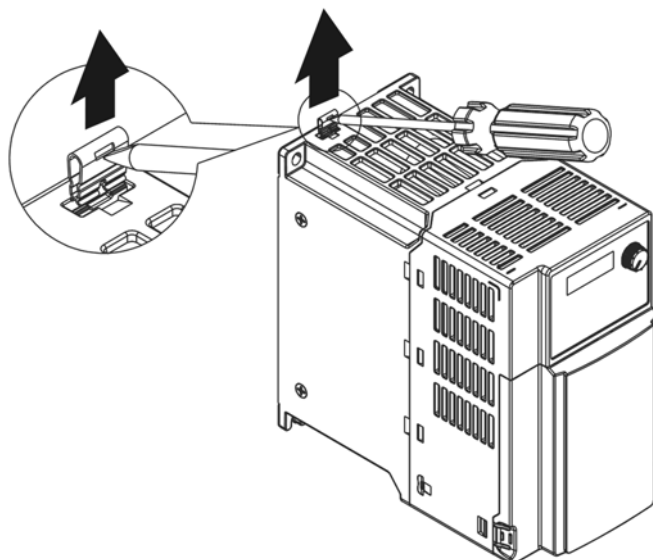

Isolating main power from ground:

When the power distribution system for the drive is a floating ground system (IT Systems) or an asymmetric ground system (Corner Grounded TN Systems), you must remove the RFI jumper. Removing the RFI jumper disconnects the internal capacitors from ground to avoid damaging the internal circuits and to reduce the ground leakage current.

Important points regarding the ground connection:

- ☑ To ensure the safety of personnel, proper operation, and to reduce electromagnetic radiation, you must properly ground the drive during installation.
- ☑ The diameter of the cables must comply with the local safety regulations.
- ☑ The shields of shielded cables must be connected to the ground of the drive to meet safety regulations.
- ☑ The shields of shielded power cables can only be used as the ground for equipment when the above points are met.
- ☑ When installing more drives, do not connect the grounds of the drives in series but connect each drive to ground. The following pictures show the correct and wrong ways to connect the grounds.

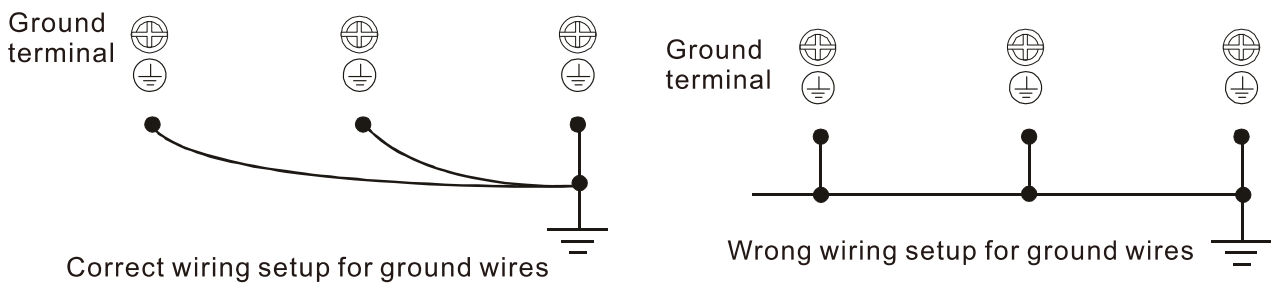

Pay particular attention to the following points:

- ☑ Do not remove the RFI jumper while the power is on.
- ☑ Removing the RFI jumper also disconnects the built-in EMC filter capacitors. Compliance with the EMC specifications is no longer guaranteed.
- ☑ Do not remove the RFI jumper if the mains power is a symmetrical grounded power system in order to maintain the efficiency for EMC circuit.
- ☑ Do not remove the RFI jumper while conducting high voltage tests. When conducting a high voltage test to the entire facility, you must disconnect the mains power and the motor if the leakage current is too high.

Floating Ground System (IT Systems)

A floating ground system is also called an IT system, an ungrounded system, or a high impedance/resistance (greater than 30 Ω) grounded system.

- ☑ Disconnect the RFI jumper.
- ☑ Check whether there is excess electromagnetic radiation affecting nearby low-voltage circuits.
- ☑ In some situations, the transformer and cable naturally provide enough EM radiation suppression. If in doubt, install an extra electrostatic shielded cable on the power supply side between the main circuit and the control terminals to increase security.
- ☑ Do not install an external EMC filter. The EMC filter is connected to ground through the filter capacitors, and connects the power input to ground. This is very dangerous and can easily damage the drive.

Asymmetric Ground System (Corner Grounded TN Systems)

Caution: Do not remove the RFI jumper while there is power to the input terminal of the drive.

In the following four situations, you must remove the RFI jumper. This is to prevent the system from grounding through the RFI and filter capacitors and damaging the drive.

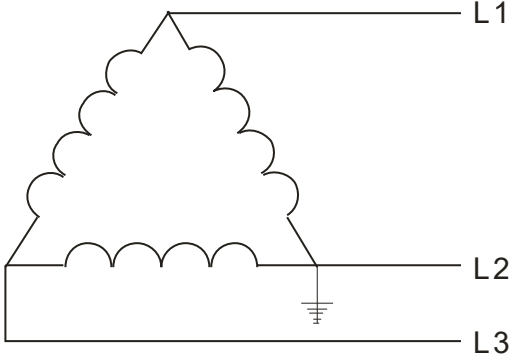
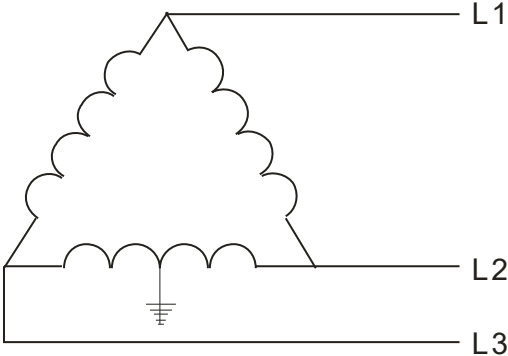
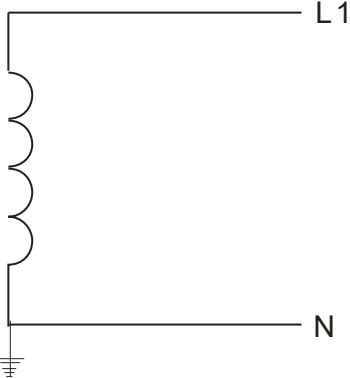
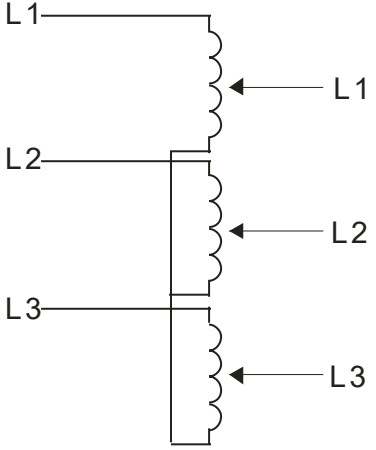
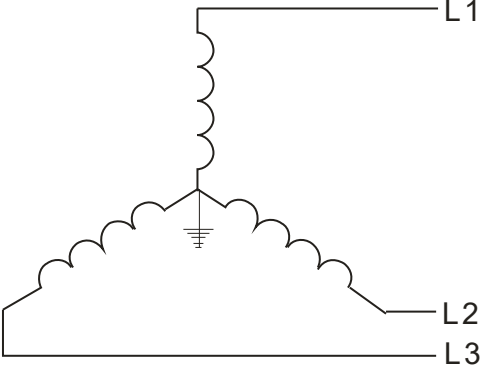
You must remove the RFI jumper	
<p>1. Grounding at a corner in a triangle configuration</p> 	<p>2. Grounding at a midpoint in a polygonal configuration</p> 
<p>3. Grounding at one end in a single-phase configuration</p> 	<p>4. No stable neutral grounding in a three-phase autotransformer configuration</p> 
You can use the RFI jumper	
<p>Internal grounding through RFI capacitors that reduce electromagnetic radiation. In a symmetrically grounding power system with higher EMC requirements, install an EMC filter. As a reference, the diagram on the right is a symmetrical grounding power system.</p>	

[This page intentionally left blank]

Chapter 2 Dimensions

Frame A

- A1: VFD0A8ME11ANNA; VFD0A8ME11ANSAA; VFD0A8ME21ANNA; VFD0A8ME21ANSAA;
 VFD0A8ME23ANNA; VFD0A8ME23ANSAA; VFD1A6ME11ANNA; VFD1A6ME11ANSAA;
 VFD1A6ME21ANNA; VFD1A6ME21ANSAA; VFD1A6ME23ANNA; VFD1A6ME23ANSAA
- A2: VFD2A8ME23ANNA; VFD2A8ME23ANSAA
- A3: VFD2A5ME11ANNA; VFD2A5ME11ANSAA; VFD2A8ME21ANNA; VFD2A8ME21ANSAA
- A4: VFD1A5ME43ANNA; VFD1A5ME43ANSAA
- A5: VFD4A8ME23ANNA; VFD4A8ME23ANSAA
- A6: VFD2A7ME43ANNA; VFD2A7ME43ANSAA

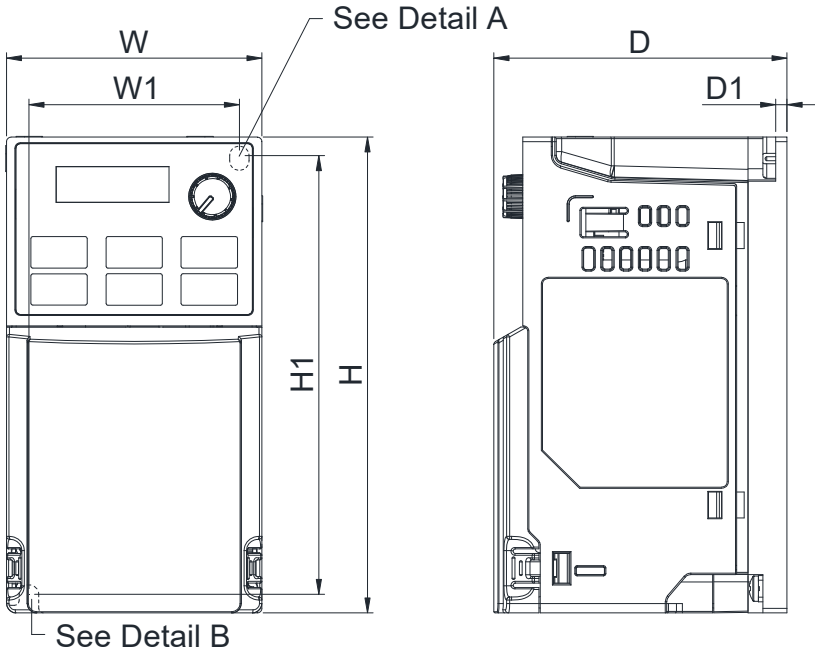

Detail A (Mounting Hole)

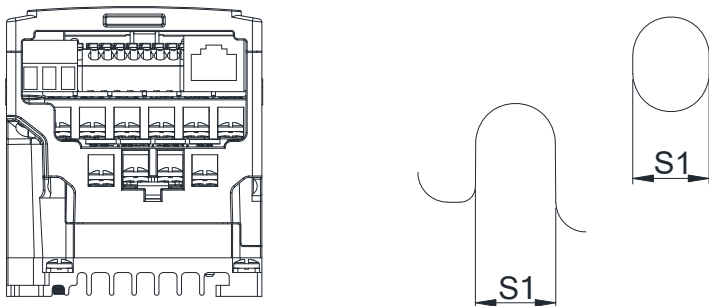

Detail B (Mounting Hole)

Unit: mm [inch]

Frame	W	H	D	W1	H1	D1	S1
A1	68.0 [2.68]	128.0 [5.04]	78.0 [3.07]	56.0 [2.20]	118.0 [4.65]	3.0 [0.12]	5.2 [0.20]
A2	68.0 [2.68]	128.0 [5.04]	92.0 [3.62]	56.0 [2.20]	118.0 [4.65]	3.0 [0.12]	5.2 [0.20]
A3	68.0 [2.68]	128.0 [5.04]	107.0 [4.21]	56.0 [2.20]	118.0 [4.65]	3.0 [0.12]	5.2 [0.20]
A4	68.0 [2.68]	128.0 [5.04]	113.0 [4.45]	56.0 [2.20]	118.0 [4.65]	3.0 [0.12]	5.2 [0.20]
A5	68.0 [2.68]	128.0 [5.04]	125.0 [4.92]	56.0 [2.20]	118.0 [4.65]	3.0 [0.12]	5.2 [0.20]
A6	68.0 [2.68]	128.0 [5.04]	127.0 [5.00]	56.0 [2.20]	118.0 [4.65]	3.0 [0.12]	5.2 [0.20]

Frame B

B1: VFD7A5ME23ANNAA; VFD7A5ME23ANSAA; VFD4A2ME43ANNAA; VFD4A2ME43ANSAA
 B2: VFD4A8ME21ANNAA; VFD4A8ME21ANSAA
 B3: VFD0A8ME21AFNAA; VFD0A8ME21AFSAA; VFD1A6ME21AFNAA; VFD1A6ME21AFSAA;
 VFD2A8ME21AFNAA; VFD2A8ME21AFSAA; VFD4A8ME21AFNAA; VFD4A8ME21AFSAA;
 VFD1A5ME43AFNAA; VFD1A5ME43AFSAA; VFD2A7ME43AFNAA; VFD2A7ME43AFSAA;
 VFD4A2ME43AFNAA; VFD4A2ME43AFSAA

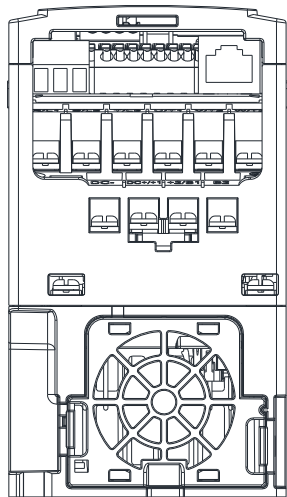
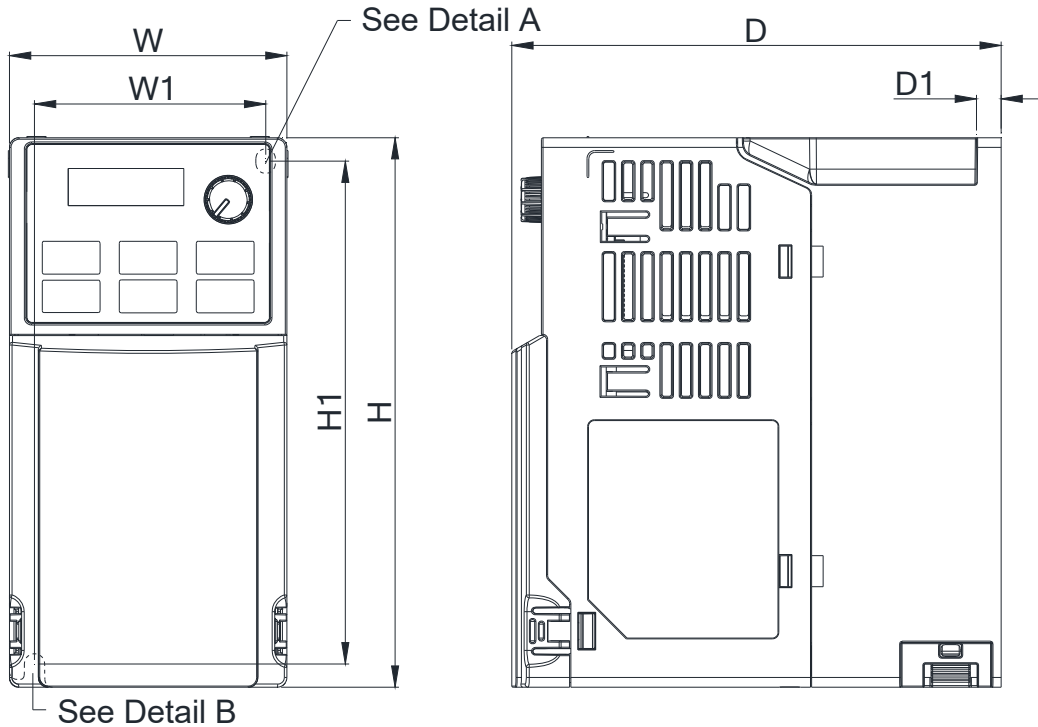

Detail A (Mounting Hole)

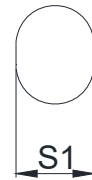

Detail B (Mounting Hole)

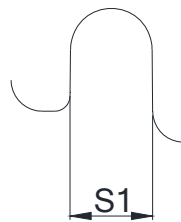

Unit: mm [inch]

Frame	W	H	D	W1	H1	D1	S1
B1	72.0 [2.83]	142.0 [5.59]	127.0 [5.00]	60.0 [2.36]	130.0 [5.12]	6.4 [0.25]	5.2 [0.20]
B2	72.0 [2.83]	142.0 [5.59]	127.0 [5.00]	60.0 [2.36]	130.0 [5.12]	3.0 [0.12]	5.2 [0.20]
B3	72.0 [2.83]	142.0 [5.59]	143.0 [5.63]	60.0 [2.36]	130.0 [5.12]	4.3 [0.17]	5.2 [0.20]

Frame C

- C1: VFD4A8ME11ANNAA; VFD4A8ME11ANSAA; VFD7A5ME21ANNAA; VFD7A5ME21ANSAA; VFD11AME21ANNAA; VFD11AME21ANSAA; VFD11AME23ANNAA; VFD11AME23ANSAA; VFD17AME23ANNAA; VFD17AME23ANSAA; VFD5A5ME43ANNAA; VFD5A5ME43ANSAA; VFD9A0ME43ANNAA; VFD9A0ME43ANSAA
 C2: VFD7A5ME21AFNAA; VFD7A5ME21AFSAA; VFD11AME21AFNAA; VFD11AME21AFSAA; VFD5A5ME43AFNAA; VFD5A5ME43AFSAA; VFD9A0ME43AFNAA; VFD9A0ME43AFSAA

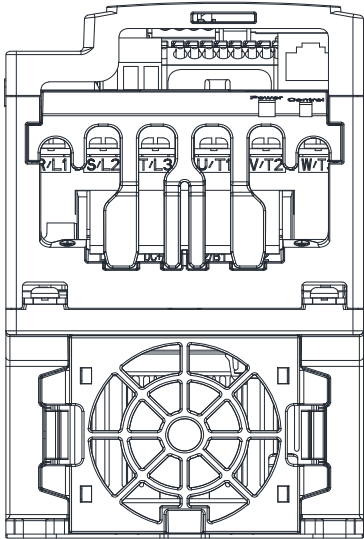
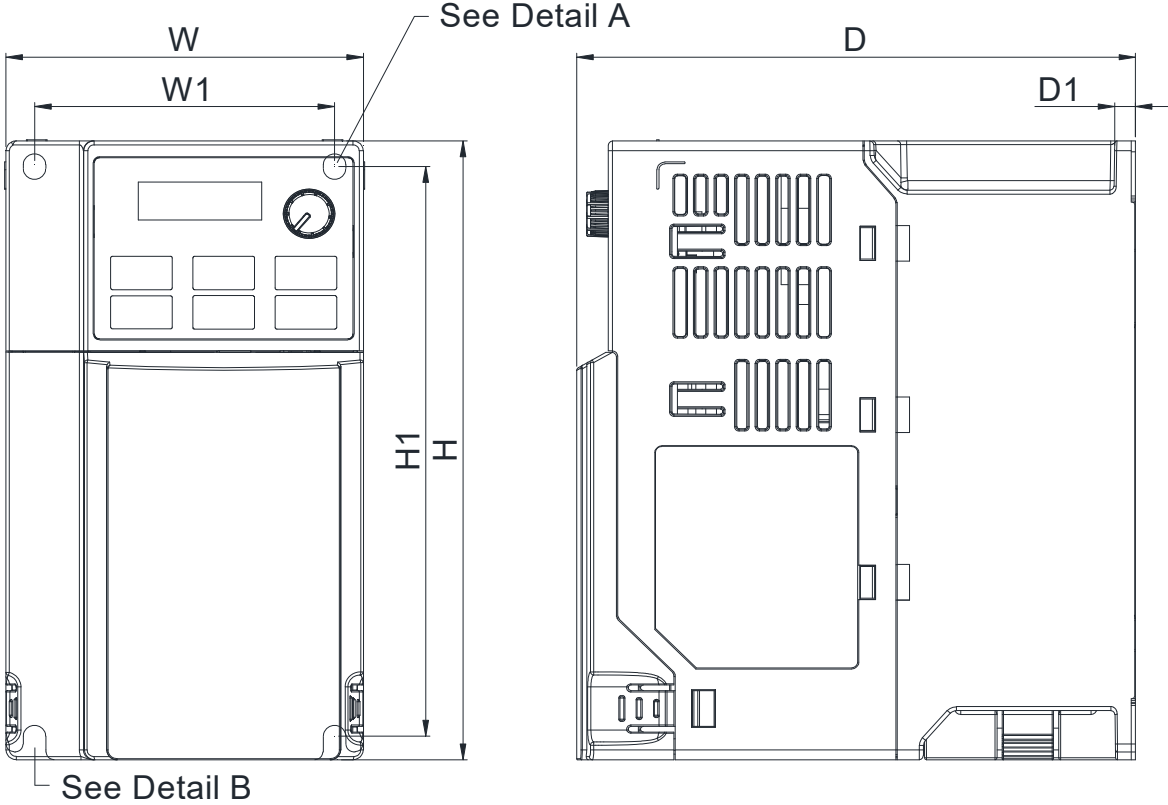

Detail A (Mounting Hole)

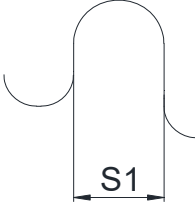
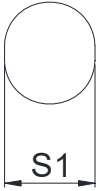

Detail B (Mounting Hole)

Unit: mm [inch]

Frame	W	H	D	W1	H1	D1	S1
C1	87.0 [3.43]	157.0 [6.18]	136.0 [5.35]	73.0 [2.87]	144.5 [5.69]	5.0 [0.20]	5.5 [0.22]
C2	87.0 [3.43]	157.0 [6.18]	163.0 [6.42]	73.0 [2.87]	144.5 [5.69]	5.0 [0.20]	5.5 [0.22]

Frame D

D1: VFD25AME23ANNA; VFD25AME23ANSAA; VFD13AME43ANNA; VFD13AME43ANSAA;
 VFD17AME43ANNA; VFD17AME43ANSAA

D2: VFD13AME43AFNA; VFD13AME43AFSA; VFD17AME43AFNA; VFD17AME43AFSA

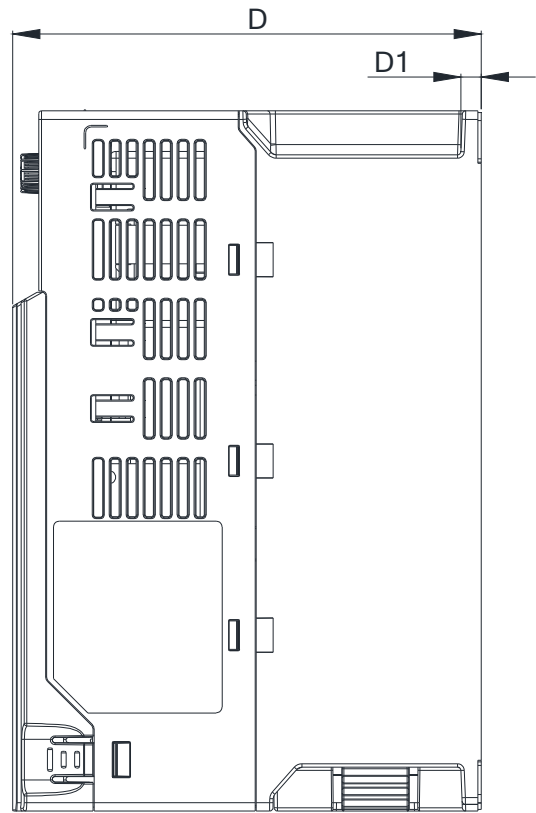
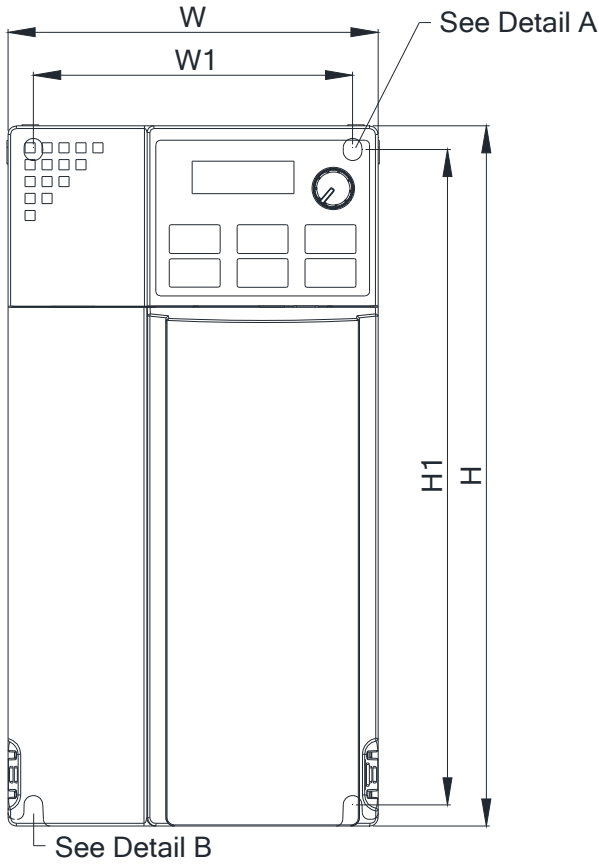

Detail A (Mounting Hole)

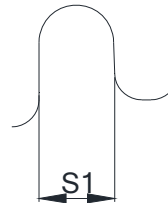
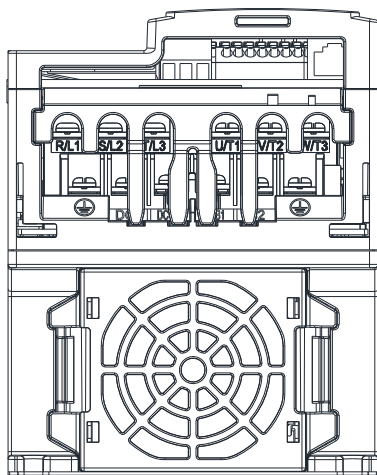

Detail B (Mounting Hole)

Unit: mm [inch]

Frame	W	H	D	W1	H1	D1	S1
D1	109.0 [4.29]	207.0 [8.15]	138.0 [5.43]	94.0 [3.70]	193.8 [7.63]	6.0 [0.24]	5.5 [0.22]
D2	109.0 [4.29]	207.0 [8.15]	171.0 [6.73]	94.0 [3.70]	193.8 [7.63]	6.0 [0.24]	5.5 [0.22]

Chapter 3 Installation

Minimum Mounting Clearance and Installation

- ☑ Prevent fiber particles, scraps of paper, shredded wood, sawdust, metal particles, etc. from adhering to the heat sink.
- ☑ Install the AC motor drive in a metal cabinet. When installing one drive below another one, use a metal separator between the AC motor drives to prevent mutual heating and to prevent the risk of accidental fire.
- ☑ Install the AC motor drive in Pollution Degree 2 environments only, where normally only non-conductive pollution occurs and temporary conductivity caused by condensation is expected.
- ☑ Mount the drive in an IP54 cabinet in order to maintain the Pollution Degree 2 or in a pollution-controlled environment.

The following figures are for reference only.

Airflow direction:  inflow  outflow  distance

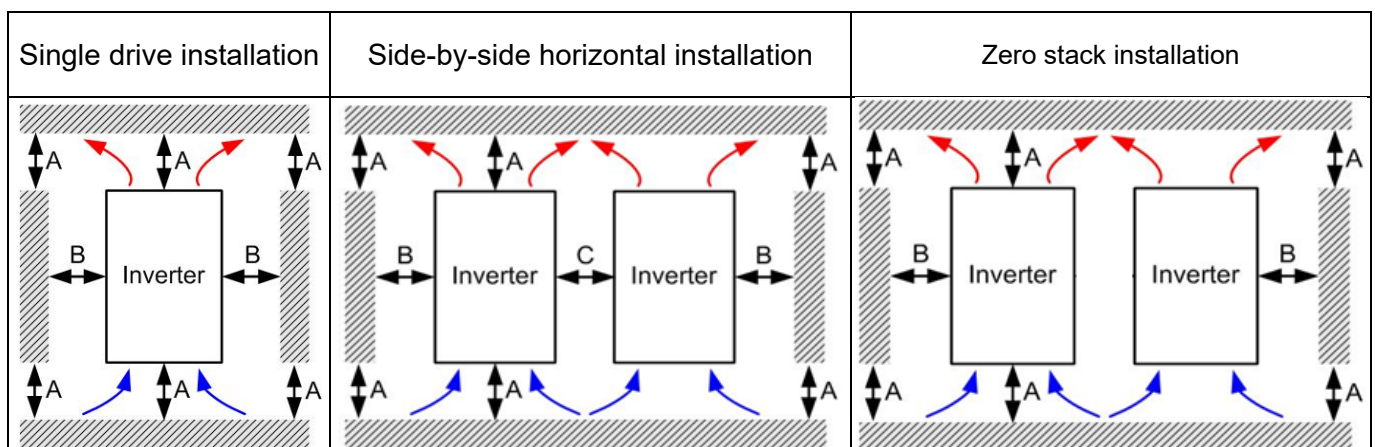

Minimum mounting clearance

Installation method	A (mm)	B (mm)	C (mm)	Ambient temperature (°C)	
				Max. (Without derating)	Max. (derating)
Single drive installation	50	30	-	50	60
Side-by-side horizontal installation	50	30	30	50	60
Zero stack installation	50	30	0	45	55

NOTE

The minimum mounting clearances A–C in the table above apply to AC motor drives installation. Failing to follow the minimum mounting clearances may cause the fan to malfunction and heat dissipation problems may occur.

Frame	Air flow rate for cooling			Power Dissipation		
	Model No.	Flow Rate (Unit: cfm)	Flow Rate (Unit: m ³ /hr)	Loss External (Heat sink, unit: W)	Internal (Unit: W)	Total (Unit: W)
A	VFD2A5ME11ANNAA VFD2A5ME11ANSAA	0	0	14.2	13.1	27.3
	VFD2A8ME21ANNAA VFD2A8ME21ANSAA			16.3	14.5	30.8
	VFD4A8ME23ANNAA VFD4A8ME23ANSAA			31	13.2	44.2
	VFD1A5ME43ANNAA VFD1A5ME43ANSAA			17.6	11.1	28.7
	VFD2A7ME43ANNAA VFD2A7ME43ANSAA			30.5	17.8	48.3
	VFD0A8ME11ANNAA VFD0A8ME11ANSAA			5.1	6.8	11.9
	VFD1A6ME11ANNAA VFD1A6ME11ANSAA			8	10	18
	VFD0A8ME21ANNAA VFD0A8ME21ANSAA			5.1	6.8	11.9
	VFD1A6ME21ANNAA VFD1A6ME21ANSAA			8	10.3	18.3
	VFD0A8ME23ANNAA VFD0A8ME23ANSAA			5.1	6.8	11.9
	VFD1A6ME23ANNAA VFD1A6ME23ANSAA			8.6	10	18.6
	VFD2A8ME23ANNAA VFD2A8ME23ANSAA			16.5	12.6	29.1
B	VFD0A8ME21AFNAA VFD0A8ME21AFSAA	0	0	5.1	6.8	11.9
	VFD1A6ME21AFNAA VFD1A6ME21AFSAA			8	10.3	18.3
	VFD2A8ME21AFNAA VFD2A8ME21AFSAA	10	16.99	16.3	14.5	30.8
	VFD4A8ME21AFNAA VFD4A8ME21AFSAA			29.1	20.1	49.2
	VFD4A8ME21ANNAA VFD4A8ME21ANSAA	0	0	29.1	20.1	49.2
	VFD7A5ME23ANNAA VFD7A5ME23ANSAA	10	16.99	50.1	24.2	74.3
	VFD4A2ME43ANNAA VFD4A2ME43AFNAA VFD4A2ME43ANSAA VFD4A2ME43AFSAA			45.9	21.7	67.6
	VFD1A5ME43AFNAA VFD1A5ME43AFSAA			17.6	11.1	28.7
VFD2A7ME43AFNAA VFD2A7ME43AFSAA	30.5			17.8	48.3	
C	VFD4A8ME11ANNAA VFD4A8ME11ANSAA	16	27.2	29.1	23.9	53
	VFD7A5ME21ANNAA VFD7A5ME21AFNAA			46.5	31	77.5

Frame	Air flow rate for cooling			Power Dissipation		
	Model No.	Flow Rate (Unit: cfm)	Flow Rate (Unit: m ³ /hr)	Loss External (Heat sink, unit: W)	Internal (Unit: W)	Total (Unit: W)
C	VFD7A5ME21ANSAA VFD7A5ME21AFSAA	16	27.2	46.5	31	77.5
	VFD11AME21ANNAA VFD11AME21AFNAA VFD11AME21ANSAA VFD11AME21AFSAA			70	35	105
	VFD11AME23ANNAA VFD11AME23ANSAA			76	30.7	106.7
	VFD17AME23ANNAA VFD17AME23ANSAA			108.2	40.1	148.3
	VFD5A5ME43ANNAA VFD5A5ME43AFNAA VFD5A5ME43ANSAA VFD5A5ME43AFSAA			60.6	22.8	83.4
	VFD9A0ME43ANNAA VFD9A0ME43AFNAA VFD9A0ME43ANSAA VFD9A0ME43AFSAA			93.1	42	135.1
D	VFD25AME23ANNAA VFD25AME23ANSAA	23.4	39.7	192.8	53.3	246.1
	VFD13AME43ANNAA VFD13AME43AFNAA VFD13AME43ANSAA VFD13AME43AFSAA			132.8	39.5	172.3
	VFD17AME43ANNAA VFD17AME43AFNAA VFD17AME43ANSAA VFD17AME43AFSAA			164.7	55.8	220.5

Derating for Ambient Temperature

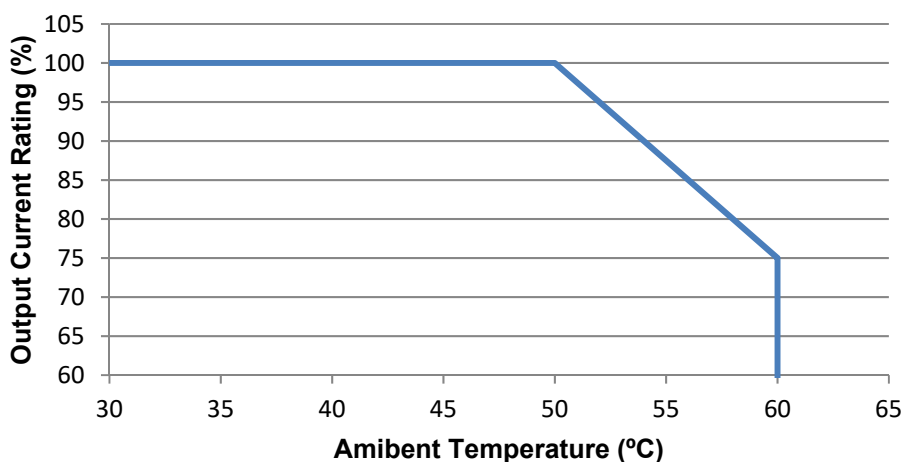

[This page intentionally left blank]

Chapter 4 Wiring

4-1 System Wiring Diagram

4-2 Wiring

After you remove the front cover, verify that the power and control terminals are clearly visible. Read the following precautions to avoid wiring mistakes.



- ☑ It is crucial to **turn off the AC motor drive power** before you make any wiring. A charge with hazardous voltages may still remain in the DC BUS capacitors even if the power is off for a short time. Measure the remaining voltage with a DC voltmeter on +1/DC+ and DC- before wiring. For your safety, do not start any wiring before the voltage drops to a safe level (less than 25 V_{DC}). Installing wiring with a residual voltage may cause injuries, sparks and short circuits.
- ☑ Only qualified personnel familiar with AC motor drives are allowed to perform installation, wiring and commissioning. Make sure the power is turned off before wiring to prevent electric shock.
- ☑ The terminals R/L1, S/L2, and T/L3 are for mains power input. If mains power is incorrectly connected to other terminals, it may result in damage to the equipment. The voltage and current must be in the range indicated on the nameplate (see Section 1-1).
- ☑ All units must be grounded directly to a common ground terminal to prevent electrical shock or damage from lightning.
- ☑ Tighten the screw of the main circuit terminals to prevent sparks due to loosening of the terminals resulted from vibration.



- ☑ When wiring, choose wires that comply with local regulations for your safety.
- ☑ Check the following items after you finish the wiring:
 1. Are all connections correct?
 2. Are there any loose wires?
 3. Are there any short circuits between the terminals or to ground?

4-1 System Wiring Diagram

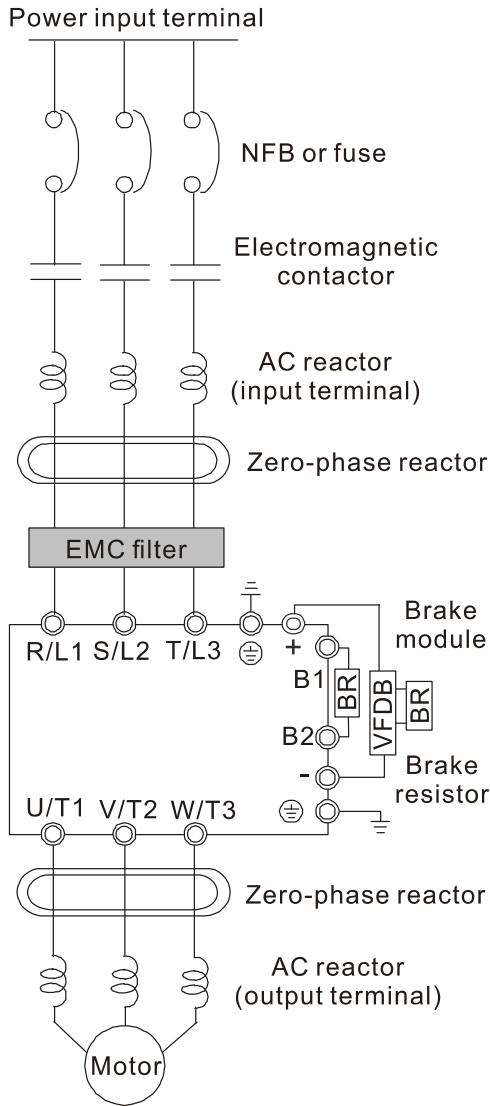

Power input terminal	Please refer to Chapter 9 Specification Table in the user manual for details.
NFB or fuse	There may be a large inrush current during power on. Refer to Section 7-2 NFB to select a suitable NFB or Section 7-3 Fuse Specification Chart.
Electromagnetic contactor	Switching the power ON/OFF before the magnetic contactor more than once per hour can damage the drive.
AC reactor (input terminal)	When the mains power capacity is > 500kVA or when the drive is preceded by a capacitor bank, the instantaneous peak voltage and current may destroy the drive. In that case it is recommended to install an AC input reactor that also improves the power factor and harmonics. The cable between reactor and drive should be < 10m. Please refer to Section 7-4.
Zero-phase reactor	Can be used to reduce radiated emission, especially in environments with audio devices, and reduce input and output side interference. The effective range is AM band to 10 MHz. Please refer to Section 7-5.
EMC filter	Can be used to reduce electromagnetic interference. Please refer to Section 7-6.
Brake module & Brake resistor (BR)	Can be used to shorten the deceleration time of the motor. Please refer to Section 7-1.
AC reactor (output terminal)	The wiring length of the motor affects switching current peaks. It is recommended to install an AC output reactor when the motor wiring length exceeds the value listed in Section 7-4.

4-2 Wiring

Input: one-phase / three-phase power

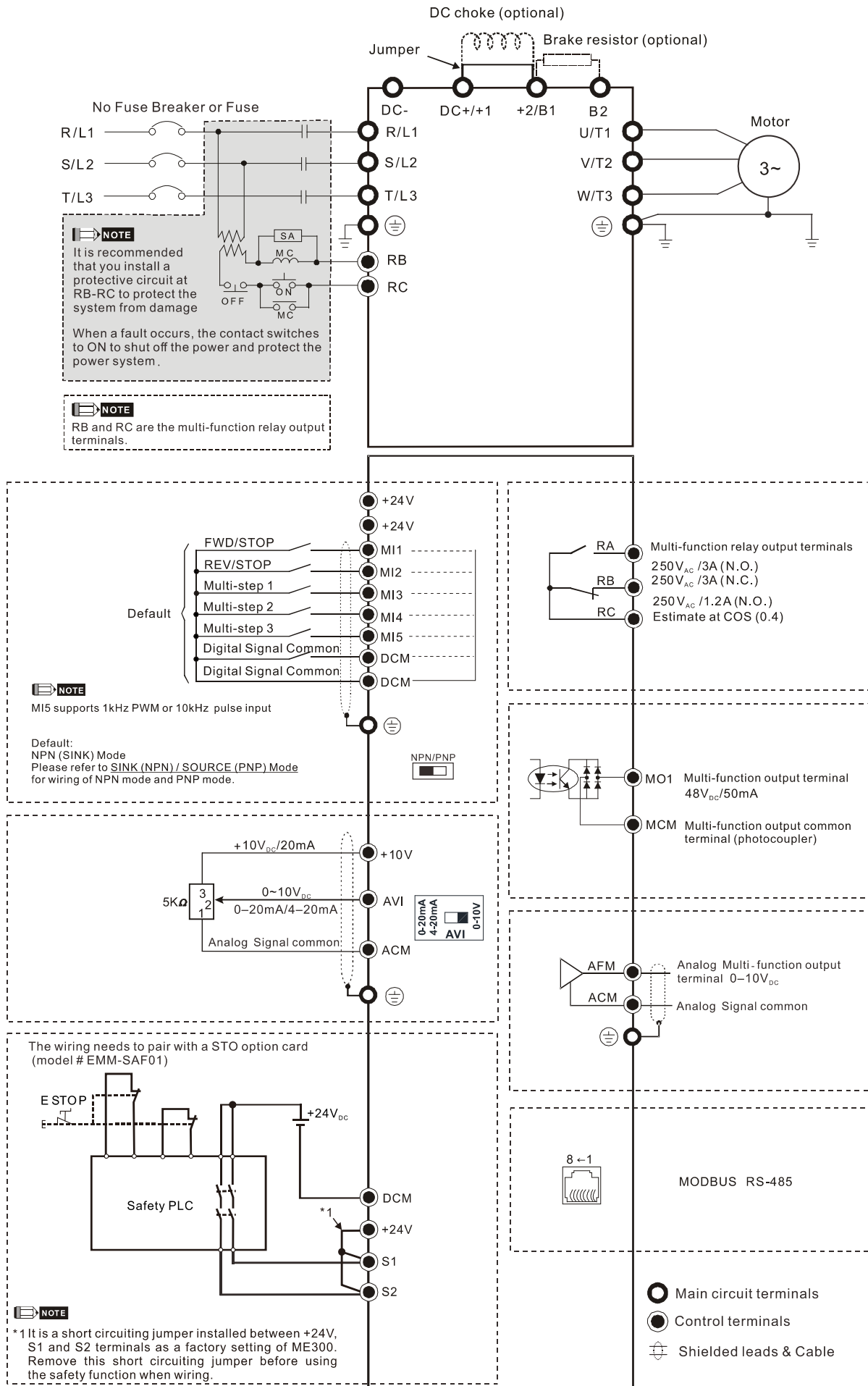

SINK (NPN) / SOURCE (PNP) Mode

① Sink Mode with internal power (+24 V_{DC})

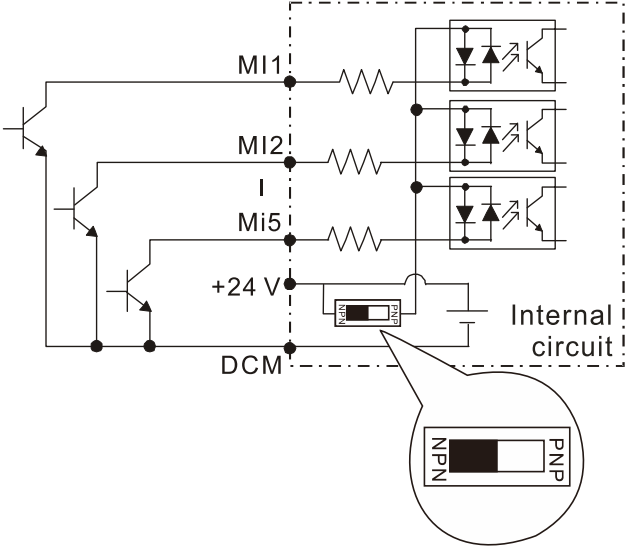

② Source Mode with internal power (+24 V_{DC})

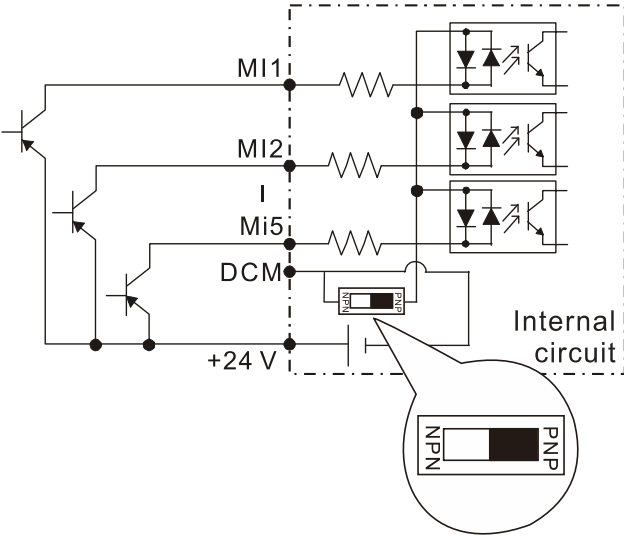

③ Sink Mode with external power

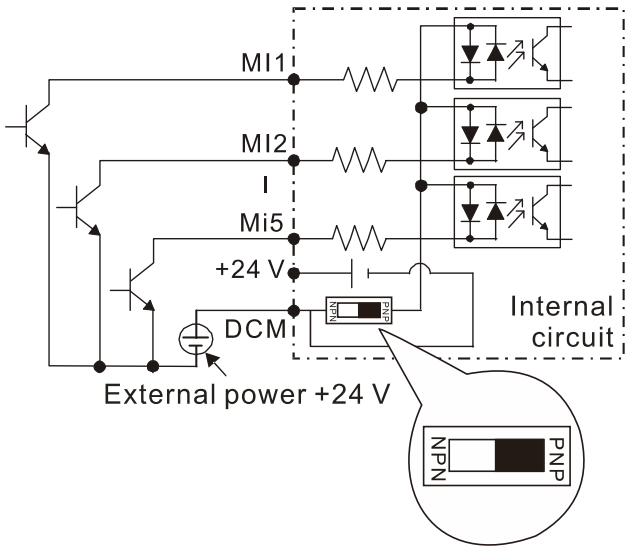

④ Source Mode with external power

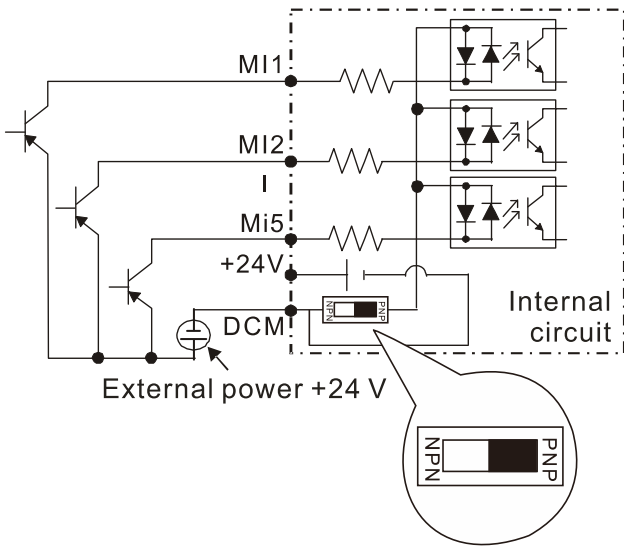

[This page intentionally left blank]

Chapter 5 Main Circuit Terminals

5-1 Main Circuit Diagram

5-2 Main Circuit Terminals



- ☑ Securely fasten the main circuit terminal screws to prevent sparking caused by loose screws due to vibration.
- ☑ If necessary, use an inductive filter only at the motor output terminals U/T1, V/T2, W/T3 of the AC motor drive. DO NOT use phase-compensation capacitors or L-C (Inductance-Capacitance) or R-C (Resistance-Capacitance), unless approved by Delta.
- ☑ DO NOT connect brake resistors directly to +1/DC+ to DC-, +2/B1 to DC- to prevent damage to the drive.
- ☑ Ensure proper insulation of the main circuit wiring in accordance with the relevant safety regulations.



Main power terminals

- ☑ R/L1, S/L2 and T/L3 have no phase-sequence requirement; they can be connected in any sequence.
- ☑ Add a magnetic contactor (MC) at the power input to quickly cut off power and reduce malfunction when activating the AC motor drive protection function. Both ends of the MC should have an R-C surge absorber.
- ☑ Ensure that voltages and currents are within specification.
- ☑ When using a general GFCI (Ground Fault Circuit Interrupter), use a current sensor with sensitivity of 200 mA or above and not less than 0.1 second operation time to avoid nuisance tripping.
- ☑ Use conduits or shielded cables for the power wiring, and ground both ends of the conduit or shielded cables.
- ☑ DO NOT start or stop the drive by turning the power ON or OFF. Start and stop the drive with the RUN/STOP command from the control terminals or keypad. If you still need to run or stop the drive by turning the power ON or OFF, it is strongly recommended that you do so no more often than ONCE per hour.
- ☑ To comply with UL standards, connect the drive to a three-phase three-wire or three-phase four-wire Wye system type of mains power system.

Output terminals for main circuit

- ☑ Use a well-insulated motor that is suitable for operation with an inverter.
- ☑ When the AC drive output terminals U/T1, V/T2, and W/T3 are connected to the motor terminals U/T1, V/T2, and W/T3 respectively, the motor rotates counterclockwise (as viewed from the shaft end of the motor) when it receives a forward operation command. To permanently reverse the direction of rotation, exchange any two motor leads.

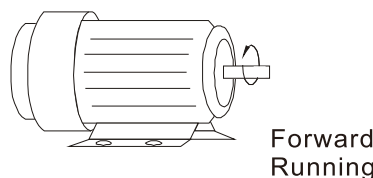

Terminals for connecting DC reactor, external brake resistor and DC circuit

- ☑ These are the terminals for connecting the DC reactor to improve the power factor and harmonics. At delivery they are shorted by a jumper. Remove the jumper before connecting the DC reactor.
- ☑ You must tightly fasten the jumper when it does not connect the DC reactor, use DC+ / +1, +2/B1 to execute common DC BUS, or connect with a brake resistor; otherwise, the drive might lose power or break the terminals.

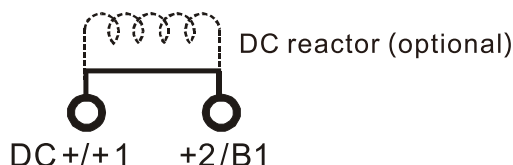

- ☑ Connect a brake resistor in applications with frequent deceleration, short deceleration time, too low braking torque, or increased braking torque.

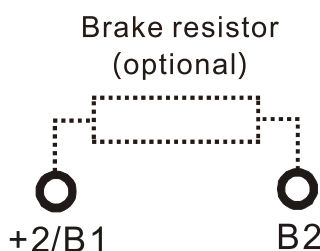

- ☑ Connect the external brake resistor to the terminals [+2/B1], [B2] on AC motor drives.
- ☑ DO NOT short-circuit or connect a brake resistor directly to DC+ / +1 and DC-, +2/B1 to DC-; otherwise, the drive will be damaged.
- ☑ Connect DC+ and DC- in common DC BUS applications. Refer to Section 5-2 (Main Circuit Terminals) for the wiring terminal specification and the wire gauge information.

Remove the front cover

- 📖 Remove the front cover before connecting the main circuit terminals and control circuit terminals. Remove the cover according to the figure below.
- 📖 The figure below shows the Frame A model for example. Removing the cover for other frame sizes is similar.

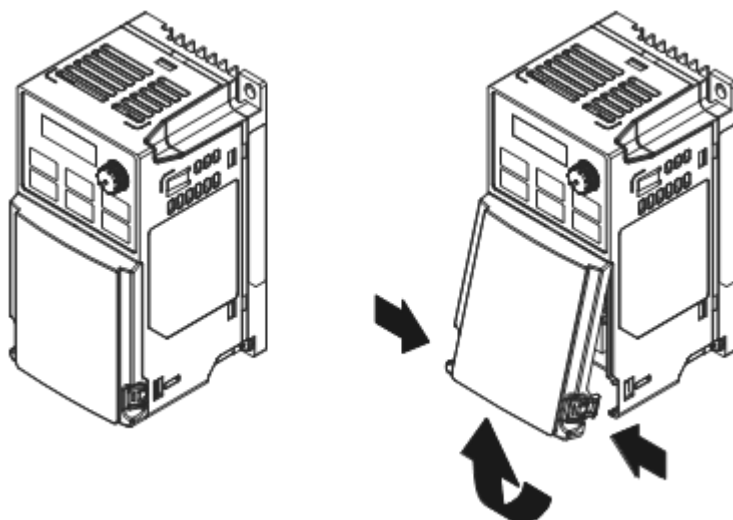

5-1 Main Circuit Diagram

Input: one-phase / three-phase power

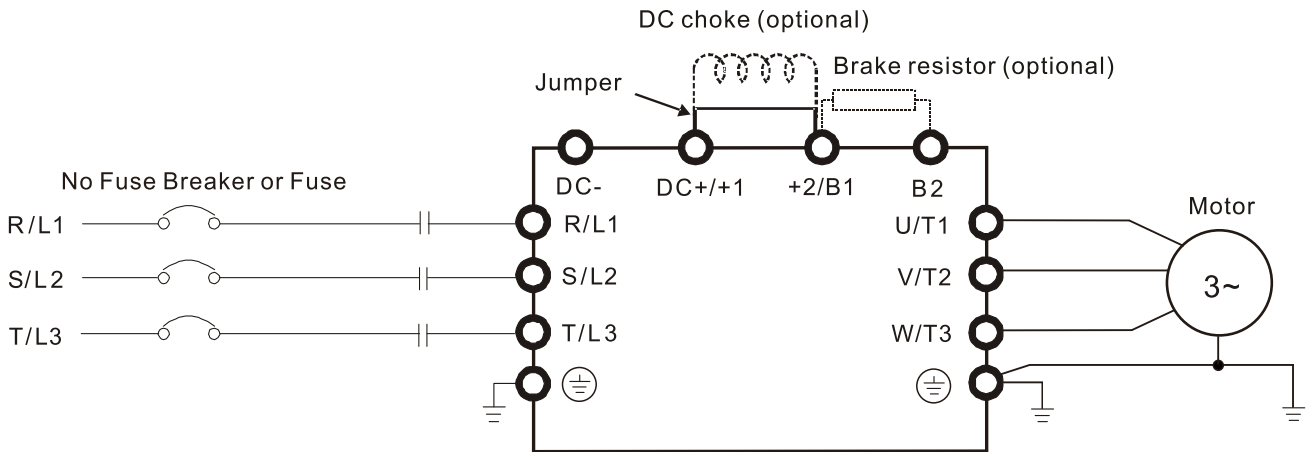

Terminals	Descriptions
R/L1, S/L2	Mains input terminals one-phase
R/L1, S/L2, T/L3	Mains input terminals three-phase
U/T1, V/T2, W/T3	Motor output terminals for connecting three-phase IM and PM motors
+1, +2	Connections for DC reactor to improve the power factor and harmonics. Remove the jumper when using a DC reactor.
DC+, DC-	Connections for brake unit (VFDB series) Common DC BUS
B1, B2	Connections for brake resistor (optional)
⊕	Ground connection; comply with local regulations.

5-2 Main Circuit Terminals

- When doing the wiring of the main circuit terminals, use the grounding terminal to increase reliability. For specifications of the grounding terminals, see Figure 1 and Figure 2. For other types of terminals, you can choose the specification yourself.
- After crimping the wire to the ring lug (must be UL approved), UL and CSA approved R/C (YDPU2), install heat shrink tubing rated at a minimum of 600 V_{AC} insulation over the live part. Refer to Figure 2 below.
- Main circuit terminals:
R/L1, S/L2, T/L3, U/T1, V/T2, W/T3, ⊕, DC-, DC+/+1, +2/B1, B2
Note: One-phase model with no T/L3 terminal.

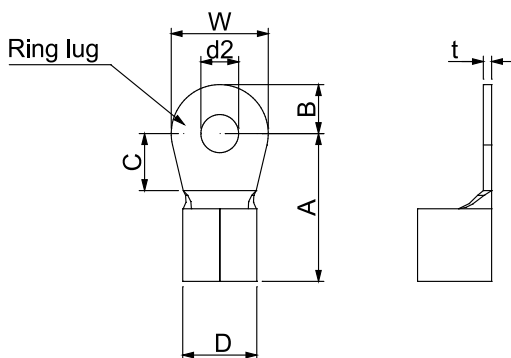

Figure 1.

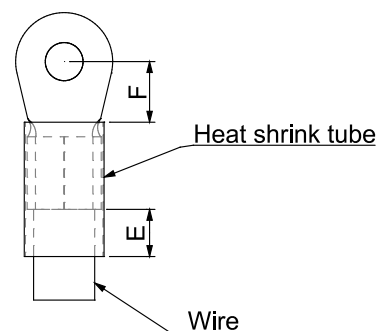

Figure 2.

Dimensions of Ring Lug

The part # of the ring terminals (produced by K.S. Terminals) in the table below are for reference only. You can buy other ring terminals of your choice to match with different frame sizes.

Frame	AWG	Kit P/N	A (MAX)	B (MAX)	C (MIN)	D (MAX)	d2 (MIN)	E (MIN)	F (MIN)	W (MAX)	t (MAX)
A	18	RNBS1-3.7	9.8	3.2	4.8	4.1	3.7	13.0	4.2	6.6	0.8
	16	RNBS2-3.7									
	14	RNBS2-3.7									
B	18	RNBS1-4	12.1	3.6	6.1	5.6	4.3	13.0	4.5	7.2	1.0
	16	RNBS1-4									
	14	RNBS2-4									
	12	RNBS5-4									
C	14	RNBS2-4	17.8	5.0	6.1	7.2	4.3	13.0	5.5	10.5	1.2
	12	RNBS5-4									
	10	RNBS5-4									
	8	RNBS8-4									
D	10	RNBS5-4	17.8	5.0	6.1	7.2	4.3	13.0	5.5	10.5	1.2
	8	RNBS8-4									

Unit: mm

Frame A

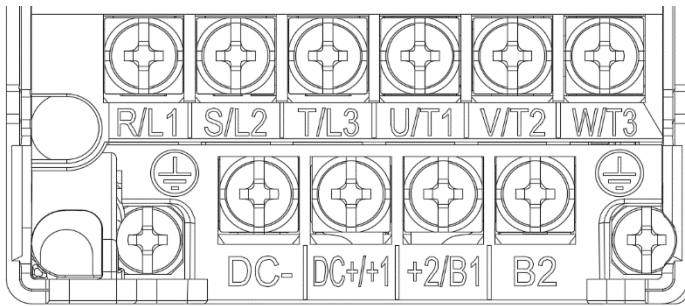

- If you install at Ta 50°C above environment, use copper wires that have a voltage rating of 600 V and are temperature resistant to 90°C or above.
- If you install at Ta 50°C environment, use copper wires that have a voltage rating of 600 V and are temperature resistant to 75°C or 90°C.
- For VFD2A5ME11ANNA, VFD2A5ME11ANSAA:
If you install at Ta 40°C above environment, use copper wires that have a voltage rating of 600 V and are temperature resistant to 90°C or above.
- To be UL installation compliant, you must use copper wires when installing. The wire gauge is based on a temperature resistance of 75°C, in accordance with UL requirements and recommendations. Do not reduce the wire gauge when using high-temperature resistant wires.

Models	Main Circuit Terminals R/L1, S/L2, T/L3, U/T1, V/T2, W/T3, DC-, DC+/+1, +2/B1, B2			Terminals ⊕		
	Max. Wire Gauge	Min. Wire Gauge	Screw & Torque (±10%)	Max. Wire Gauge	Min. Wire Gauge	Screw & Torque (±10%)
VFD0A8ME11ANNA VFD0A8ME11ANSAA	2.5mm ² [14AWG]	0.75 mm ² [18 AWG]	M3.5 9 kg-cm [7.8 lb-in.] [0.88 Nm]	2.5 mm ² [14 AWG]	2.5 mm ² [14 AWG]	M3.5 9 kg-cm [7.8 lb-in.] [0.88 Nm]
VFD1A6ME11ANNA VFD1A6ME11ANSAA		2.5 mm ² [14 AWG]				
VFD2A5ME11ANNA VFD2A5ME11ANSAA		0.75 mm ² [18 AWG]				
VFD0A8ME21ANNA VFD0A8ME21ANSAA		1.5 mm ² [16 AWG]				
VFD1A6ME21ANNA VFD1A6ME21ANSAA		2.5 mm ² [14 AWG]				
VFD2A8ME21ANNA VFD2A8ME21ANSAA		0.75 mm ² [18 AWG]				
VFD0A8ME23ANNA VFD0A8ME23ANSAA		1.5 mm ² [16 AWG]				
VFD1A6ME23ANNA VFD1A6ME23ANSAA		0.75 mm ² [18 AWG]				
VFD2A8ME23ANNA VFD2A8ME23ANSAA		1.5 mm ² [16 AWG]				
VFD4A8ME23ANNA VFD4A8ME23ANSAA		0.75 mm ² [18 AWG]				
VFD1A5ME43ANNA VFD1A5ME43ANSAA		0.75 mm ² [18 AWG]				
VFD2A7ME43ANNA VFD2A7ME43ANSAA						

Frame B

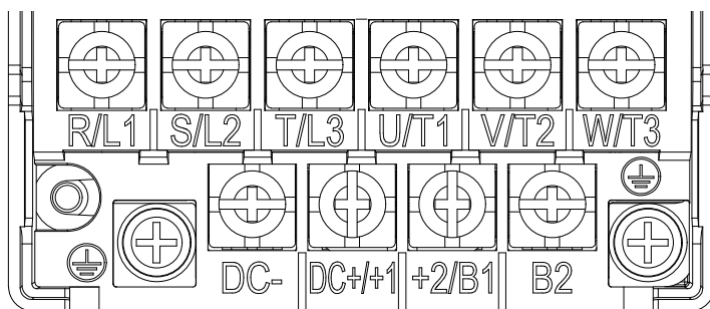

- If you install at Ta 50°C above environment, use copper wires that have a voltage rating of 600 V and are temperature resistant to 90°C or above.
- If you install at Ta 50°C environment, use copper wires that have a voltage rating of 600 V and are temperature resistant to 75°C or 90°C.
- To be UL installation compliant, you must use copper wires when installing. The wire gauge is based on a temperature resistance of 75°C, in accordance with UL requirements and recommendations. Do not reduce the wire gauge when using high-temperature resistant wires.

Models	Main Circuit Terminals R/L1, S/L2, T/L3, U/T1, V/T2, W/T3, DC-, DC+/+1, +2/B1, B2			Terminals ⊕		
	Max. Wire Gauge	Min. Wire Gauge	Screw & Torque (±10%)	Max. Wire Gauge	Min. Wire Gauge	Screw & Torque (±10%)
VFD0A8ME21AFNAA VFD0A8ME21AFSAA	4 mm ² [12 AWG]	0.75mm ² [18AWG]	M4 15 Kg-cm [13.0 lb-in.] [1.47 Nm]	2.5mm ² [14 AWG]	2.5mm ² [14 AWG]	M4 15 Kg-cm [13.0 lb-in.] [1.47 Nm]
VFD1A6ME21AFNAA VFD1A6ME21AFSAA		1.5mm ² [16AWG]				
VFD2A8ME21AFNAA VFD2A8ME21AFSAA		2.5mm ² [14 AWG]"				
VFD4A8ME21ANNAA VFD4A8ME21AFNAA VFD4A8ME21ANSAA VFD4A8ME21AFSAA		4 mm ² [12 AWG]		4 mm ² [12 AWG]		
VFD7A5ME23ANNAA VFD7A5ME23ANSAA		0.75mm ² [18AWG]		2.5mm ² [14 AWG]		
VFD1A5ME43AFNAA VFD1A5ME43AFSAA						
VFD2A7ME43AFNAA VFD2A7ME43AFSAA						
VFD4A2ME43ANNAA VFD4A2ME43AFNAA VFD4A2ME43ANSAA VFD4A2ME43AFSAA					2.5mm ² [14 AWG]	

Frame C

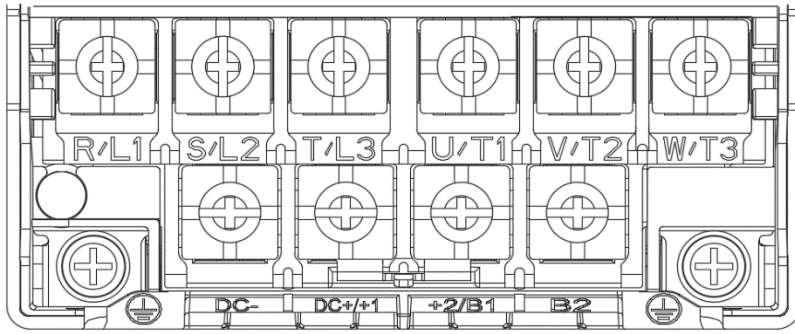

- If you install at Ta 50°C above environment, use copper wires that have a voltage rating of 600 V and are temperature resistant to 90°C or above.
- If you install at Ta 50°C environment, use copper wires that have a voltage rating of 600 V and are temperature resistant to 75°C or 90°C.
- To be UL installation compliant, you must use copper wires when installing. The wire gauge is based on a temperature resistance of 75°C, in accordance with UL requirements and recommendations. Do not reduce the wire gauge when using high-temperature resistant wires.

Models	Main Circuit Terminals R/L1, S/L2, T/L3, U/T1, V/T2, W/T3, DC-, DC+/+1, +2/B1, B2			Terminals ⊕		
	Max. Wire Gauge	Min. Wire Gauge	Screw & Torque (±10%)	Max. Wire Gauge	Min. Wire Gauge	Screw & Torque (±10%)
VFD4A8ME11ANNAA VFD4A8ME11ANSAA	10 mm ² [8 AWG]	10 mm ² [8 AWG]	M4 20 Kg-cm [17.4 lb-in.] [1.96 Nm]	10 mm ² [8 AWG]	10 mm ² [8 AWG]	M4 20 Kg-cm [17.4 lb-in.] [1.96 Nm]
VFD7A5ME21ANNAA VFD7A5ME21AFNAA VFD7A5ME21ANSAA VFD7A5ME21AFSAA						
VFD11AME21ANNAA VFD11AME21AFNAA VFD11AME21ANSAA VFD11AME21AFSAA						
VFD11AME23ANNAA VFD11AME23ANSAA		6 mm ² [10 AWG]		6 mm ² [10 AWG]		
VFD17AME23ANNAA VFD17AME23ANSAA		10 mm ² [8 AWG]		10 mm ² [8 AWG]		
VFD5A5ME43ANNAA VFD5A5ME43AFNAA VFD5A5ME43ANSAA VFD5A5ME43AFSAA		2.5 mm ² [14 AWG]		2.5 mm ² [14 AWG]		
VFD9A0ME43ANNAA VFD9A0ME43AFNAA VFD9A0ME43ANSAA VFD9A0ME43AFNAA		4 mm ² [12 AWG]		4 mm ² [12 AWG]		

Frame D

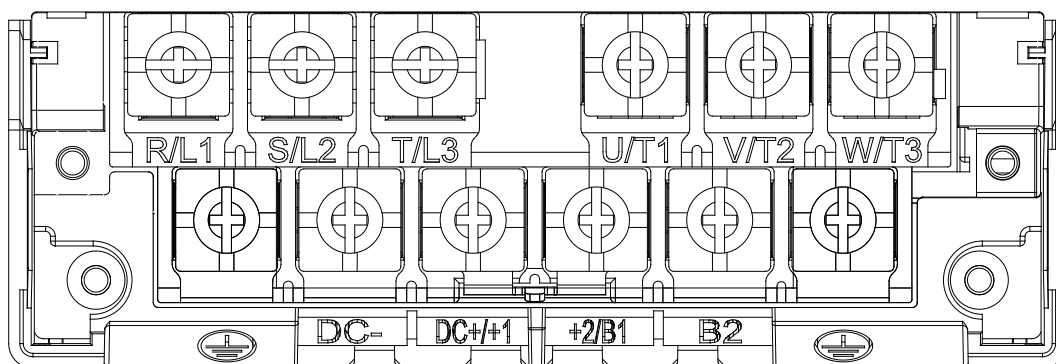

- If you install at Ta 50°C above environment, use copper wires that have a voltage rating of 600 V and are temperature resistant to 90°C or above.
- If you install at Ta 50°C environment, use copper wires that have a voltage rating of 600 V and are temperature resistant to 75°C or 90°C.
- For VFD25AME23ANNAA, VFD25AME23ANSAA:
If you install at Ta 45°C above environment, use copper wires that have a voltage rating of 600 V and are temperature resistant to 90°C or above.
- To be UL installation compliant, you must use copper wires when installing. The wire gauge is based on a temperature resistance of 75°C, in accordance with UL requirements and recommendations. Do not reduce the wire gauge when using high-temperature resistant wires.

Models	Main Circuit Terminals R/L1, S/L2, T/L3, U/T1, V/T2, W/T3, DC-, DC+/+1, +2/B1, B2			Terminals ⊕		
	Max. Wire Gauge	Min. Wire Gauge	Screw & Torque (±10%)	Max. Wire Gauge	Min. Wire Gauge	Screw & Torque (±10%)
VFD25AME23ANNAA VFD25AME23ANSAA	10 mm ² [8 AWG]	10 mm ² [8 AWG]	M4 20 Kg-cm [17.4 lb-in.] [1.96 Nm]	10 mm ² [8 AWG]	10 mm ² [8 AWG]	M4 20 Kg-cm [17.4 lb-in.] [1.96 Nm]
VFD13AME43ANNAA VFD13AME43AFNAA VFD13AME43ANSAA VFD13AME43AFSAA		6 mm ² [10 AWG]		6 mm ² [10 AWG]	6 mm ² [10 AWG]	
VFD17AME43ANNAA VFD17AME43AFNAA VFD17AME43ANSAA VFD17AME43AFSAA		10 mm ² [8 AWG]		10 mm ² [8 AWG]	10 mm ² [8 AWG]	

[This page intentionally left blank]

Chapter 6 Control Terminals



Analog input terminals (AI, ACM)

- ☑ Analog input signals are easily affected by external noise. Use shielded wiring and keep it as short as possible (less than 20 m) with proper grounding. If the noise is inductive, connecting the shield to the ACM terminal can reduce interference.
- ☑ Use twisted-pair wire for weak analog signals.
- ☑ If the analog input signals are affected by noise from the drive, connect a capacitor and ferrite core as shown in the following diagram.

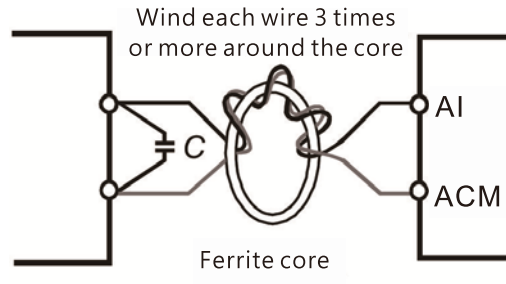

Contact input terminals (MI1–MI5, DCM, +24 V)

- ① Sink Mode with internal power (+24 V_{DC})

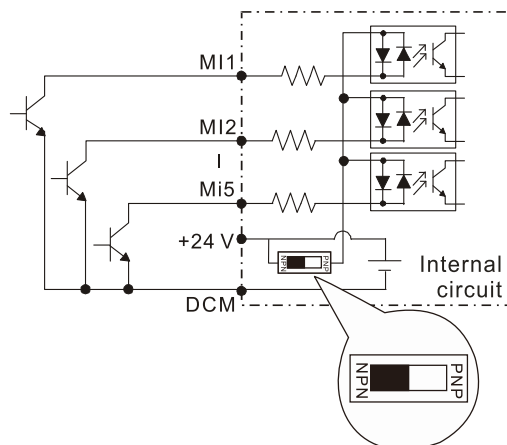

- ② Source Mode with internal power (+24 V_{DC})

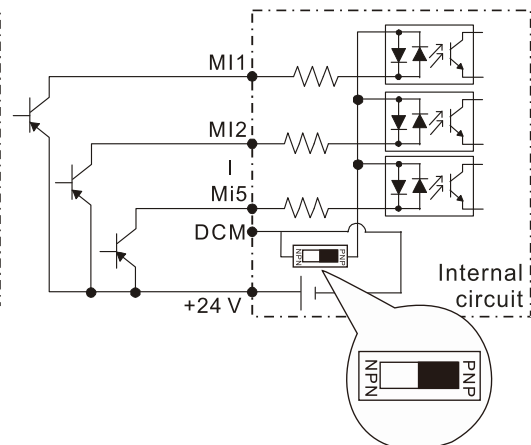

- ③ Sink Mode with external power

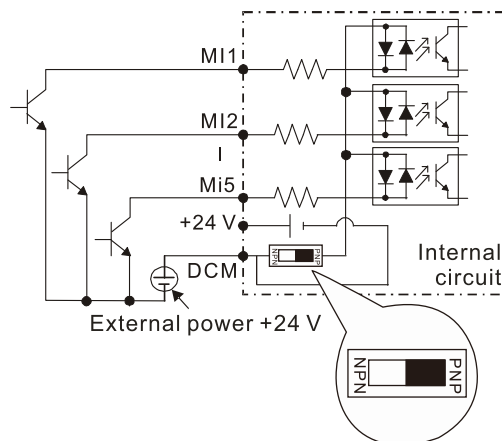

- ④ Source Mode with external power

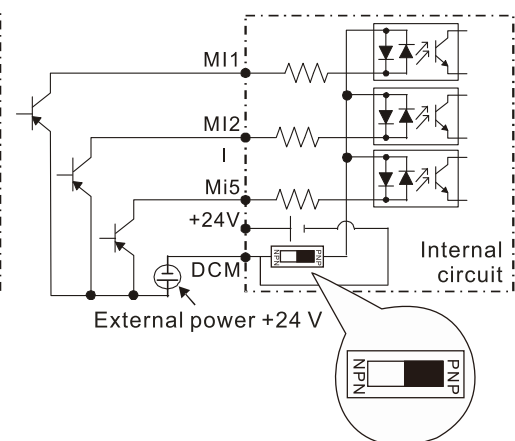

- ☑ When the photo coupler is using the internal power supply, the switch connection for Sink and Source modes are as shown in the picture above: MI-DCM: Sink mode, MI-+24 V: Source mode.

Transistor output terminals (MO1, MCM)

- ☑ Make sure to connect the digital outputs to the correct polarity. See the wiring diagram when connecting a relay to the digital output, connect a surge absorber across the coil, and check the polarity.

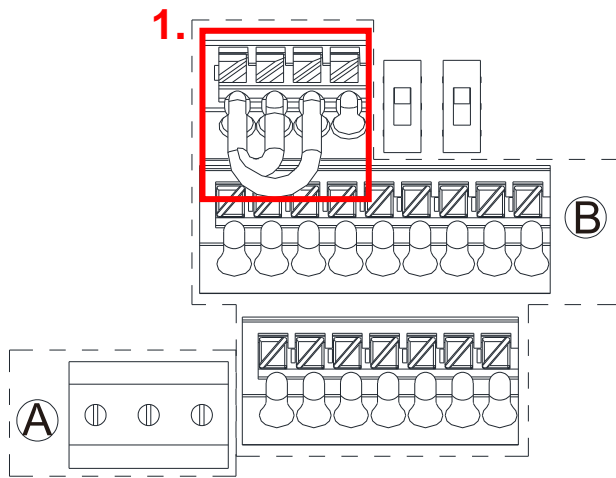

Control Terminal Distribution Diagram

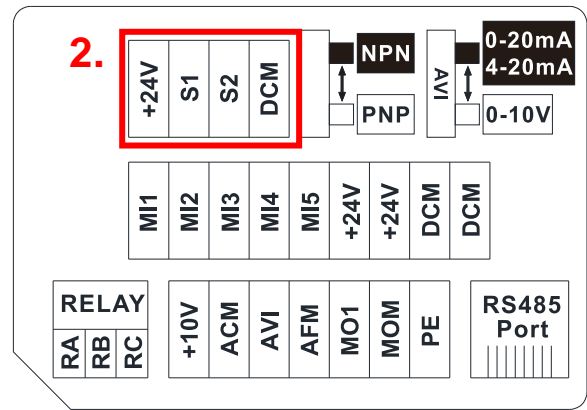

Control Terminal Location Map

Wiring precautions:

- As 1. and 2. shows in the figure above, +24 V, S1, S2, and DCM are for STO only.
- The default condition is +24 V/S1/S2 shorted by jumper of build-in STO model, as 1. shows in the figure above. Refer to Chapter 4 WIRING for more details.
- The +24 V of safety function is for STO only, as 1. and 2. shows in the figure above, and cannot be used for other purpose.
- The RELAY terminal uses the PCB terminal block (as area A shows in the figure above):
 1. Tighten the wiring with a 3.5 mm (wide) x 0.6 mm (thick) slotted screwdriver.
 2. The ideal length of stripped wire at the connection side is 9–10 mm.
 3. When wiring bare wires, make sure they are perfectly arranged to go through the wiring holes.
- The Control terminal uses a spring clamp terminal block (as area B shows in the figure above):
 1. Tighten the wiring with a 2.5 mm (wide) x 0.4 mm (thick) slotted screwdriver.
 2. The ideal length of stripped wire at the connection side is 9 mm.
 3. When wiring bare wires, make sure they are perfectly arranged to go through the wiring holes.

Wiring Specifications of Control Terminals

Function name	Conductor	Stripping length (mm)	Maximum Wire Gauge	Minimum Wire Gauge	Screw size Tightening torque (±10%)
RELAY Terminals	Conductor cross section solid wire	9–10	1.5 mm ² [16 AWG]	0.2 mm ² [24 AWG]	5 Kg-cm [4.3 lb-in.] [0.49 Nm]
	Conductor cross section stranded wire				
Control Terminals	Conductor cross section solid wire	9	0.75 mm ² [18 AWG]	0.25 mm ² [24 AWG]	/
	Conductor cross section stranded wire	9	0.5 mm ² [20 AWG]		
	Stranded with ferrules with plastic sleeve				

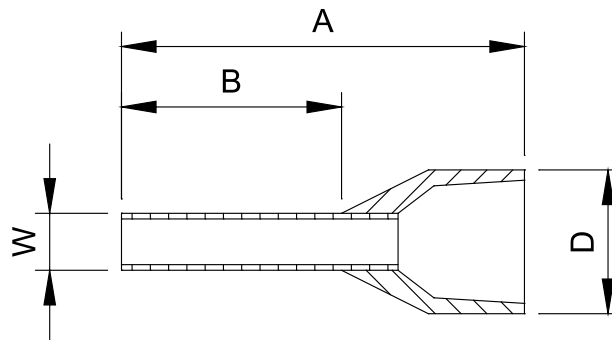

Unit: mm

Recommended model and size of crimp terminals						
AWG	VENDOR	VENDOR P/N	A (MAX)	B (MAX)	D (MAX)	W (MAX)
0.25 mm ² [24 AWG]	PHOENIX CONTACT	AI 0,25- 8 YE	12.5	8	2.6	1.1
0.34 mm ² [22 AWG]	PHOENIX CONTACT	AI 0,34- 8 TQ	12.5	8	3.3	1.3
0.5 mm ² [20 AWG]	PHOENIX CONTACT	AI 0,5 - 8 WH	14	8	3.5	1.4

Recommended model and specifications of crimp tool:
 CRIMPFOX 10S - 1212045, Manufacturer: PHOENIX CONTACT
 DNT13-0101, Manufacturer: DINKLE

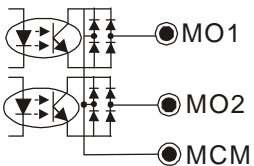
Terminals	Terminal Function	Description
+24 V	Digital control signal common (Source)	+24 V \pm 10% 100 mA
MI1 – MI5	Multi-function input 1–5	Refer to Pr.02-01–Pr.02-05 to program the multi-function inputs MI1–MI5. Source Mode ON: the activation current is 3.3 mA \geq 11 V _{DC} OFF: cut-off voltage \leq 5 V _{DC} Sink Mode ON: the activation current is 3.3 mA \leq 13 V _{DC} OFF: cut-off voltage \geq 19 V _{DC} ■ When Pr.02-00 = 0, MI1 and MI2 can be programmed. ■ When Pr.02-00 \neq 0, the function of MI1 and MI2 is according to Pr.02-00 setting. ■ When MI5 uses pulse input, the maximum input frequency = 10 kHz. ■ When MI5 uses PWM pulse input, the maximum input frequency = 1 kHz.
MO1	Multi-function Output 1 (photo coupler)	Programmable open-collector outputs, see Pr.02-16. 
MCM	Multi-function Output Common	
		Max 48 V _{DC} 50 mA

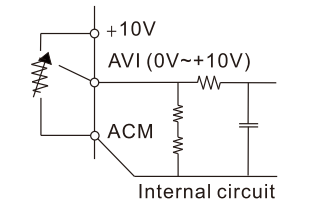
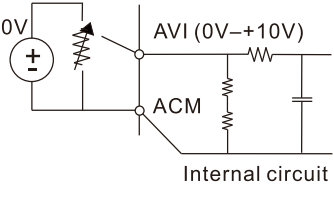
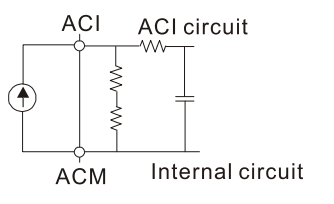
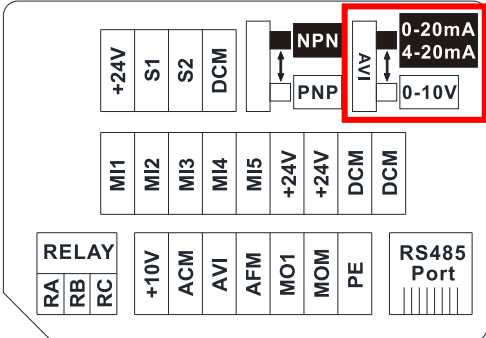
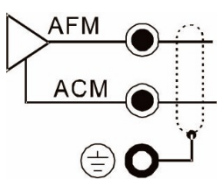
Terminals	Terminal Function	Description
RA	Multi-function relay output 1 (Relay N.O. a)	Programmable relay output, see Pr.02-13. Resistive Load 3 A (N.O.)/3 A (N.C.) 250 V _{AC} 5 A (N.O.)/3 A (N.C.) 30 V _{DC}
RB	Multi-function relay output 1 (Relay N.C. b)	Inductive Load (COS 0.4) 1.2 A (N.O.)/1.2 A (N.C.) 250 V _{AC} 2.0 A (N.O.)/1.2 A (N.C.) 30 V _{DC}
RC	Multi-function relay common (Relay)	Various kinds of monitor signals output, e.g.: operation, frequency reached, overload indication etc.
+10 V	Potentiometer power supply	+10.5±0.5 V _{DC} /20 mA
AVI	<p>Analog voltage input</p>  <p>Internal circuit</p>  <p>Internal circuit</p> <p>Analog current input</p>  <p>Internal circuit</p>	<p>The AVI terminal default voltage mode is set to 0–10 V. To use the current mode, the AVI must be switched to the current mode position (0–20 mA/4–20 mA), as the red frame below shows, and then set Pr.03-28.</p>  <p>Voltage (AVI) mode Programmable analog input, see Pr.03-00. Impedance: 20 kΩ Range 0–Max. Output Frequency (Pr.01-00): 0 to 10 V/-10 to 10 V Range switching according to Pr.03-00, Pr.03-28.</p> <p>Current (ACI) mode Programmable analog input, see Pr.03-01. Impedance: 250 Ω Range 0– Maximum Output Frequency (Pr.01-00): 0–20 mA/4–20 mA/0–10 V Range switching according to Pr.03-01, Pr.03-28.</p>
AFM	<p>Multi-function analog voltage output</p> 	<p>Switch: The AFM default is 0–10 V (voltage mode). Voltage mode Range: 0–10 V (Pr.03-31=0) corresponding to the maximum operating range of the control object Maximum output current: 2 mA. Maximum Load: 5 kΩ</p>

Terminals	Terminal Function	Description
ACM	Analog Signal Common	Common for analog terminals
RJ45	PIN 1, 2, 6: Reserved PIN 5: SG+	PIN 3, 7: GND2 PIN 4: SG- PIN 8: D+10 V (provide KPC-CC01 power supply)

[This page intentionally left blank]

Chapter 7 Optional Accessories

- 7-1 All Brake Resistors and Brake Units Used in AC Motor Drives
- 7-2 Non-fuse Circuit Breaker
- 7-3 Fuse Specification Chart
- 7-4 AC/DC Reactor
- 7-5 Zero Phase Reactors
- 7-6 EMC Filter
- 7-7 EMC Shield Plate
- 7-8 Capacitive Filter
- 7-9 Conduit Box
- 7-10 Fan Kit
- 7-11 DIN-Rail Mounting
- 7-12 Mounting Adapter Plate
- 7-13 Digital Keypad—KPC-CC01, KPC-CE01

The optional accessories listed in this chapter are available upon request. Installing additional accessories to your drive substantially improves the drive’s performance. Select accessories according to your need or contact your local distributor for suggestions.

7-1 All Brake Resistors and Brake Units Used in AC Motor Drives

115V one-phase

Model	Applicable Motor		*1 125% Braking Torque 10% ED					Max. Braking Torque			
	HP	kW	*2 Braking Torque [kg-m]	Resistor value spec. for each AC motor Drive	Braking Resistor for each Brake Unit			Braking Current [A]	Min. Resistor Value [Ω]	Max. Total Braking Current [A]	Peak Power [kW]
					*3 Part No.	Amount	Usage				
VFD0A8ME11ANNAA VFD0A8ME11ANSAA	0.13	0.1	0.1	80W 750Ω	BR080W750	1	-	0.5	380.0	1	0.4
VFD1A6ME11ANNAA VFD1A6ME11ANSAA	0.25	0.2	0.1	80W 750Ω	BR080W750	1	-	0.5	190.0	2	0.8
VFD2A5ME11ANNAA VFD2A5ME11ANSAA	0.5	0.4	0.3	80W 200Ω	BR080W200	1	-	1.9	95.0	4	1.5
VFD4A8ME11ANNAA VFD4A8ME11ANSAA	1	0.75	0.5	80W 200Ω	BR080W200	1	-	1.9	63.3	6	2.3

230V one-phase

Model	Applicable Motor		*1 125% Braking Torque 10% ED					Max. Braking Torque			
	HP	kW	*2 Braking Torque [kg-m]	Resistor value spec. for each AC motor Drive	Braking Resistor for each Brake Unit			Braking Current [A]	Min. Resistor Value [Ω]	Max. Total Braking Current [A]	Peak Power [kW]
					*3 Part No.	Amount	Usage				
VFD0A8ME21ANNAA VFD0A8ME21AFNAA VFD0A8ME21ANSAA VFD0A8ME21AFSAA	0.13	0.1	0.1	80W 750Ω	BR080W750	1	-	0.5	380.0	1	0.4
VFD1A6ME21ANNAA VFD1A6ME21AFNAA VFD1A6ME21ANSAA VFD1A6ME21AFSAA	0.25	0.2	0.1	80W 750Ω	BR080W750	1	-	0.5	190.0	2	0.8
VFD2A8ME21ANNAA VFD2A8ME21AFNAA VFD2A8ME21ANSAA VFD2A8ME21AFSAA	0.5	0.4	0.3	80W 200Ω	BR080W200	1	-	1.9	95.0	4	1.5
VFD4A8ME21ANNAA VFD4A8ME21AFNAA VFD4A8ME21ANSAA VFD4A8ME21AFSAA	1	0.75	0.5	80W 200Ω	BR080W200	1	-	1.9	63.3	6	2.3
VFD7A5ME21ANNAA VFD7A5ME21AFNAA VFD7A5ME21ANSAA VFD7A5ME21AFSAA	2	1.5	1	200W 91Ω	BR200W091	1	-	4.2	47.5	8	3.0
VFD11AME21ANNAA VFD11AME21AFNAA VFD11AME21ANSAA VFD11AME21AFSAA	3	2.2	1.5	300W 70Ω	BR300W070	1	-	5.4	38.0	10	3.8

230V three-phase

Model	Applicable Motor		*1 125% Braking Torque 10% ED					Max. Braking Torque			
	HP	kW	*2 Braking Torque [kg-m]	Resistor value spec. for each AC motor Drive	Braking Resistor for each Brake Unit			Braking Current [A]	Min. Resistor Value [Ω]	Max. Total Braking Current [A]	Peak Power [kW]
					*3 Part No.	Amount	Usage				
VFD0A8ME23ANNAA VFD0A8ME23ANSAA	0.13	0.1	0.1	80W 750Ω	BR080W750	1	-	0.5	380.0	1	0.4
VFD1A6ME23ANNAA VFD1A6ME23ANSAA	0.25	0.2	0.1	80W 750Ω	BR080W750	1	-	0.5	190.0	2	0.8
VFD2A8ME23ANNAA VFD2A8ME23ANSAA	0.5	0.4	0.3	80W 200Ω	BR080W200	1	-	1.9	95.0	4	1.5
VFD4A8ME23ANNAA VFD4A8ME23ANSAA	1	0.75	0.5	80W 200Ω	BR080W200	1	-	1.9	63.3	6	2.3
VFD7A5ME23ANNAA VFD7A5ME23ANSAA	2	1.5	1	200W 91Ω	BR200W091	1	-	4.2	47.5	8	3.0
VFD11AME23ANNAA VFD11AME23ANSAA	3	2.2	1.5	300W 70Ω	BR300W070	1	-	5.4	38.0	10	3.8

Model	Applicable Motor		*1 125% Braking Torque 10% ED						Max. Braking Torque		
	HP	kW	*2 Braking Torque [kg-m]	Resistor value spec. for each AC motor Drive	Braking Resistor for each Brake Unit			Braking Current [A]	Min. Resistor Value [Ω]	Max. Total Braking Current [A]	Peak Power [kW]
					*3 Part No.	Amount	Usage				
VFD17AME23ANNAA VFD17AME23ANSAA	5	3.7	2.5	400W 40Ω	BR400W040	1	-	9.5	19.0	20	7.6
VFD25AME23ANNAA VFD25AME23ANSAA	7.5	5.5	3.7	1000W 20Ω	BR1K0W020	1		19	16.5	23	8.7

460V three-phase

Model	Applicable Motor		*1 125% Braking Torque 10% ED						Max. Braking Torque		
	HP	kW	*2 Braking Torque [kg-m]	Resistor value spec. for each AC motor Drive	Braking Resistor for each Brake Unit			Braking Current [A]	Min. Resistor Value [Ω]	Max. Total Braking Current [A]	Peak Power [kW]
					*3 Part No.	Amount	Usage				
VFD1A5ME43ANNAA VFD1A5ME43AFNAA VFD1A5ME43ANSAA VFD1A5ME43AFSAA	0.5	0.4	0.3	80W 750Ω	BR080W750	1	-	1	380.0	2	1.5
VFD2A7ME43ANNAA VFD2A7ME43AFNAA VFD2A7ME43ANSAA VFD2A7ME43AFSAA	1	0.75	0.5	80W 750Ω	BR080W750	1	-	1	190.0	4	3.0
VFD4A2ME43ANNAA VFD4A2ME43AFNAA VFD4A2ME43ANSAA VFD4A2ME43AFSAA	2	1.5	1	200W 360Ω	BR200W360	1	-	2.1	126.7	6	4.6
VFD5A7ME43ANNAA VFD5A7ME43AFNAA VFD5A7ME43ANSAA VFD5A7ME43AFSAA	3	2.2	1.5	300W 250Ω	BR300W250	1	-	3	108.6	7	5.3
VFD09AME43ANNAA VFD09AME43AFNAA VFD09AME43ANSAA VFD09AME43AFSAA	5	3.7	2.5	400W 150Ω	BR400W150	1	-	5.1	84.4	9	6.8
VFD13AME43ANNAA VFD13AME43AFNAA VFD13AME43ANSAA VFD13AME43AFSAA	7.5	5.5	3.7	1000W 75Ω	BR1K0W075	1	-	10.2	50.7	15	11.4
VFD17AME43ANNAA VFD17AME43AFNAA VFD17AME43ANSAA VFD17AME43AFSAA	10	7.5	5.1	1000W 75Ω	BR1K0W075	1	-	10.2	40.0	19	14.4

*1. Standard braking torque is 125%. Because of the limited resistor power, the longest operation time for 10% ED is 10 seconds (on: 10 seconds / off: 90 seconds).

*2. Calculation for braking torque is for a four-pole motor 1800 rpm.

*3. Resistors of 400 W or lower should be fixed to the frame and at a surface temperature below 250°C.

Resistors of 1000 W and above should be fixed on a surface with temperature below 600°C.

 **NOTE**

- Select the resistance value, power and brake usage (ED %) according to Delta rules.

Definition for Brake Usage ED%

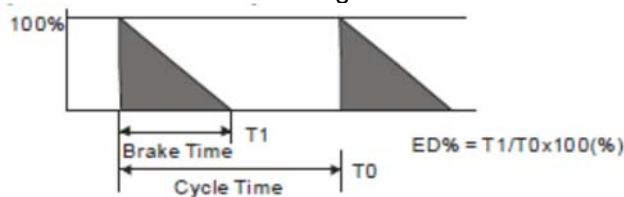

Explanation: ED (%) is defined to allow enough time for the brake unit and brake resistor to dissipate the heat generated by braking. Recommended cycle time T0 is one minute.

For safety, install a thermal overload relay (O.L) between the brake unit and the brake resistor in conjunction with the magnetic contactor (MC) before the drive for additional protection. The thermal overload relay protects the brake resistor from damage due to frequent or continuous braking. Under such circumstances, turn off the power to prevent damage to the brake resistor, brake unit and drive.

2. Any damage to the drive or other equipment caused by using brake resistors and brake modules that are not provided by Delta voids the warranty.
3. Consider environmental safety factors when installing the brake resistors. If you use the minimum resistance value, consult local dealers for the power calculation.
4. When using more than two brake units, the equivalent resistor value of the parallel brake unit cannot be less than the value in the column "Minimum Resistor Value [Ω]". Read the wiring information in the brake unit instruction sheet thoroughly prior to operation. Visit the following links to get the instruction sheets for the wiring in the brake unit:

- VFDB2015 / 2022 / 4030 / 4045 / 5055 Braking Modules Instruction Sheet
http://www.deltaww.com/filecenter/Products/download/06/060101/Option/DELTA_IA-MDS_VFDB_I_EN_20070719.pdf
- VFDB4110 / 4160 / 4185 Braking Modules Instruction Sheet
http://www.deltaww.com/filecenter/Products/download/06/060101/Option/DELTA_IA-MDS_VFDB4110-4160-4185_I_EN_20101011.pdf
- VFDB6055 / 6110 / 6160 / 6200 Braking Modules Instruction Sheet
http://www.deltaww.com/filecenter/Products/download/06/060101/Option/DELTA_IA-MDS_VFDB6055-6110-6160-6200_I_TSE_20121030.pdf

5. Thermal Overload Relay (TOR):

Choosing a thermal overload relay is based on whether its overload capacity is appropriate for the ME300. The standard braking capacity of the ME300 is 10% ED (Tripping time=10 s). As shown in the figure below, the thermal overload relay continuously operates for 10 seconds and it can withstand a 260% overload (Host starting). For example, a 460V, 7.5 kW ME300 has a braking current of 10.2 A (refer to the tables in this section), so it can use the thermal overload relay with a rated current of 5 A ($5 \times 260\% = 13 \text{ A} > 10.2 \text{ A}$).

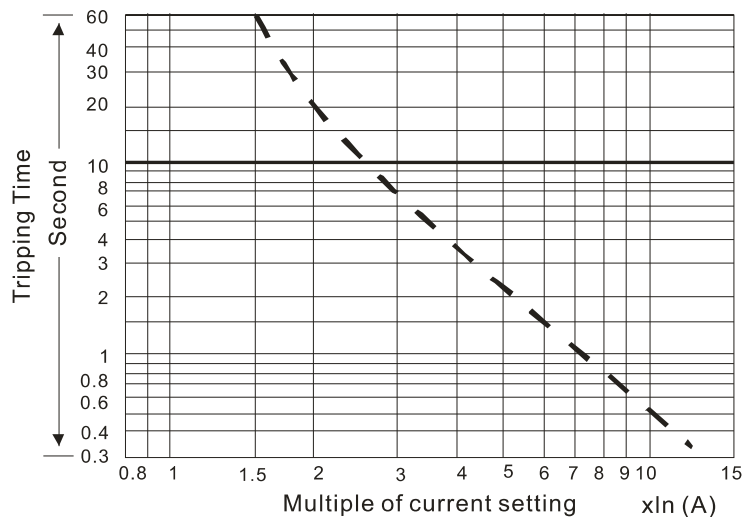

7-2 Non-fuse Circuit Breaker

Comply with the UL standard: Per UL 508, paragraph 45.8.4, part a.

The rated current of the breaker shall be 1.6–2.6 times of the maximum rated input current of the AC motor drive.

Model	Voltage/one-phase (three-phase)	Breaker Rating Input [A]	
		Heavy duty	
VFD0A8ME11ANNAA VFD0A8ME11ANSAA	115V/one-phase	20	
VFD1A6ME11ANNAA VFD1A6ME11ANSAA		20	
VFD2A5ME11ANNAA VFD2A5ME11ANSAA		25	
VFD4A8ME11ANNAA VFD4A8ME11ANSAA		50	
VFD0A8ME21ANNAA VFD0A8ME21AFNAA VFD0A8ME21ANSAA VFD0A8ME21AFSAA	230V/one-phase	15	
VFD1A6ME21ANNAA VFD1A6ME21AFNAA VFD1A6ME21ANSAA VFD1A6ME21AFSAA		15	
VFD2A8ME21ANNAA VFD2A8ME21AFNAA VFD2A8ME21ANSAA VFD2A8ME21AFSAA		20	
VFD4A8ME21ANNAA VFD4A8ME21AFNAA VFD4A8ME21ANSAA VFD4A8ME21AFSAA		30	
VFD7A5ME21ANNAA VFD7A5ME21AFNAA VFD7A5ME21ANSAA VFD7A5ME21AFSAA		45	
VFD11AME21ANNAA VFD11AME21AFNAA VFD11AME21ANSAA VFD11AME21AFSAA		70	
VFD0A8ME23ANNAA VFD0A8ME23ANSAA		230V/three-phase	15
VFD1A6ME23ANNAA VFD1A6ME23ANSAA			15
VFD2A8ME23ANNAA VFD2A8ME23ANSAA	15		
VFD4A8ME23ANNAA VFD4A8ME23ANSAA	15		
VFD7A5ME23ANNAA VFD7A5ME23ANSAA	25		

Model	Voltage/one-phase (three-phase)	Breaker Rating Input [A]
		Heavy duty
VFD11AME23ANNAA VFD11AME23ANSAA	230V/three-phase	40
VFD17AME23ANNAA VFD17AME23ANSAA		60
VFD25AME23ANNAA VFD25AME23ANSAA		63
VFD1A5ME43ANNAA VFD1A5ME43AFNAA VFD1A5ME43ANSAA VFD1A5ME43AFSAA	460V/three-phase	15
VFD2A7ME43ANNAA VFD2A7ME43AFNAA VFD2A7ME43ANSAA VFD2A7ME43AFSAA		15
VFD4A2ME43ANNAA VFD4A2ME43AFNAA VFD4A2ME43ANSAA VFD4A2ME43AFSAA		15
VFD5A5ME43ANNAA VFD5A5ME43AFNAA VFD5A5ME43ANSAA VFD5A5ME43AFSAA		20
VFD9A0ME43ANNAA VFD9A0ME43AFNAA VFD9A0ME43ANSAA VFD9A0ME43AFSAA		30
VFD13AME43ANNAA VFD13AME43AFNAA VFD13AME43ANSAA VFD13AME43AFSAA		32
VFD17AME43ANNAA VFD17AME43AFNAA VFD17AME43ANSAA VFD17AME43AFSAA		45

7-3 Fuse Specification Chart

- ☑ Fuse specifications lower than the table below are allowed.
- ☑ For installation in the United States, branch circuit protection must be provided in accordance with the National Electrical Code (NEC) and any applicable local codes. Use UL classified fuses to fulfill this requirement.
- ☑ For installation in Canada, branch circuit protection must be provided in accordance with Canadian Electrical Code and any applicable provincial codes. Use UL classified fuses to fulfill this requirement.

Model	Voltage/one-phase (three-phase)	Branch Circuit Fuses Output [A]
VFD0A8ME11ANNAA VFD0A8ME11ANSAA	115V/one-phase	7.2
		Class T JJS-10
VFD1A6ME11ANNAA VFD1A6ME11ANSAA		7.2
		Class T JJS-10
VFD2A5ME11ANNAA VFD2A5ME11ANSAA		10.8
		Class T JJS-10
VFD4A8ME11ANNAA VFD4A8ME11ANSAA		22
		Class T JJS-25
VFD0A8ME21ANNAA VFD0A8ME21AFNAA VFD0A8ME21ANSAA VFD0A8ME21AFSAA	230V/one-phase	7.2
		Class T JJS-10
VFD1A6ME21ANNAA VFD1A6ME21AFNAA VFD1A6ME21ANSAA VFD1A6ME21AFSAA		7.2
		Class T JJS-10
VFD2A8ME21ANNAA VFD2A8ME21AFNAA VFD2A8ME21ANSAA VFD2A8ME21AFSAA		12.8
		Class T JJS-15
VFD4A8ME21ANNAA VFD4A8ME21AFNAA VFD4A8ME21ANSAA VFD4A8ME21AFSAA		20
		Class T JJS-20
VFD7A5ME21ANNAA VFD7A5ME21AFNAA VFD7A5ME21ANSAA VFD7A5ME21AFSAA		34
		Class T JJS-35
VFD11AME21ANNAA VFD11AME21AFNAA VFD11AME21ANSAA VFD11AME21AFSAA		50
		Class T JJS-50
VFD0A8ME23ANNAA VFD0A8ME23ANSAA	230V/three-phase	7.2
		Class T JJS-10
VFD1A6ME23ANNAA VFD1A6ME23ANSAA		7.2
		Class T JJS-10

Model	Voltage/one-phase (three-phase)	Branch Circuit Fuses Output [A]
VFD2A8ME23ANNAA VFD2A8ME23ANSAA	230V/three-phase	12.8
		Class T JJS-15
VFD4A8ME23ANNAA VFD4A8ME23ANSAA		20
		Class T JJS-20
VFD7A5ME23ANNAA VFD7A5ME23ANSAA		32
		Class T JJS-35
VFD11AME23ANNAA VFD11AME23ANSAA		50
		Class T JJS-50
VFD17AME23ANNAA VFD17AME23ANSAA		78
	Class T JJS-80	
VFD25AME23ANNAA VFD25AME23ANSAA		59.4
		Class T JJS-60
VFD1A5ME43ANNAA VFD1A5ME43AFNAA VFD1A5ME43ANSAA VFD1A5ME43AFSAA	460V/three-phase	7.2
		Class T JJS-10
VFD2A7ME43ANNAA VFD2A7ME43AFNAA VFD2A7ME43ANSAA VFD2A7ME43AFSAA		12
		Class T JJS-15
VFD4A2ME43ANNAA VFD4A2ME43AFNAA VFD4A2ME43ANSAA VFD4A2ME43AFSAA		18.4
		Class T JJS-20
VFD5A5ME43ANNAA VFD5A5ME43AFNAA VFD5A5ME43ANSAA VFD5A5ME43AFSAA		26
		Class T JJS-25
VFD9A0ME43ANNAA VFD9A0ME43AFNAA VFD9A0ME43ANSAA VFD9A0ME43AFSAA		42
		Class T JJS-45
VFD13AME43ANNAA VFD13AME43AFNAA VFD13AME43ANSAA VFD13AME43AFSAA		34.54
		Class T JJS-35
VFD17AME43ANNAA VFD17AME43AFNAA VFD17AME43ANSAA VFD17AME43AFSAA		45.1
		Class T JJS-45

7-4 AC/DC Reactor

AC Input Reactor

Installing an AC reactor on the input side of an AC motor drive can increase line impedance, improve the power factor, reduce input current, and reduce interference generated from the motor drive. It also reduces momentary voltage surges or abnormal current spikes. For example, when the main power capacity is higher than 500 kVA, or when using a switching capacitor bank, momentary voltage and current spikes may damage the AC motor drive’s internal circuit. An AC reactor on the input side of the AC motor drive protects it by suppressing surges.

Installation

Install an AC input reactor in series with the main power to the three input phases R S T as shown below:

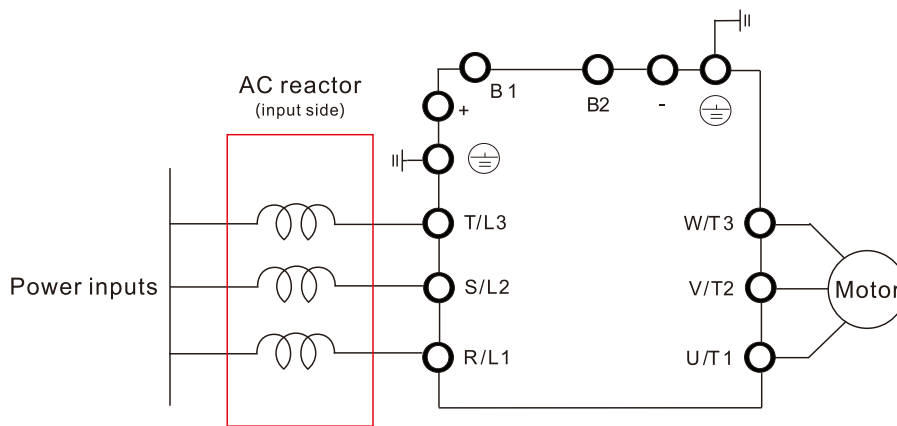

Connecting an AC input reactor

115V, 50–60 Hz / One-Phase - Normal Duty

Model	Rated Current ND / HD [Arms]	Saturation ND / HD Current [Arms]	3% Input/ Output Reactor [mH]	5% Input/ Output Reactor [mH]	3% Input Reactor Delta Part #
VFD0A8ME11ANNAA VFD0A8ME11ANSAA	3.7	5.55	2.968	4.947	N/A
VFD1A6ME11ANNAA VFD1A6ME11ANSAA	6.8	10.2	1.615	2.692	
VFD2A5ME11ANNAA VFD2A5ME11ANSAA	10.1	15.15	1.087	1.812	
VFD4A8ME11ANNAA VFD4A8ME11ANSAA	20.6	30.9	0.533	0.888	

* For one-phase models, choose your models based on the input current. No recommended model.

115V, 50–60 Hz / One-Phase - Heavy Duty

Model	Rated Current ND / HD [Arms]	Saturation ND / HD Current [Arms]	3% Input/ Output Reactor [mH]	5% Input/ Output Reactor [mH]	3% Input Reactor Delta Part #
VFD0A8ME11ANNAA VFD0A8ME11ANSAA	3	6	3.661	6.102	N/A
VFD1A6ME11ANNAA VFD1A6ME11ANSAA	6	12	1.830	3.05	
VFD2A5ME11ANNAA VFD2A5ME11ANSAA	9.4	18.8	1.168	1.947	
VFD4A8ME11ANNAA VFD4A8ME11ANSAA	18	36	0.610	1.017	

* For one-phase models, choose your models based on the input current. No recommended model.

230V, 50–60 Hz / One-Phase - Normal Duty

Model	Rated Current ND / HD [Arms]	Saturation ND / HD Current [Arms]	3% Input/ Output Reactor [mH]	5% Input/ Output Reactor [mH]	3% Input Reactor Delta Part #
VFD0A8ME21ANNAA VFD0A8ME21AFNAA VFD0A8ME21ANSAA VFD0A8ME21AFSAA	3.2	4.8	5.857	9.762	DR005D0585
VFD1A6ME21ANNAA VFD1A6ME21AFNAA VFD1A6ME21ANSAA VFD1A6ME21AFSAA	3.8	5.7			
VFD2A8ME21ANNAA VFD2A8ME21AFNAA VFD2A8ME21ANSAA VFD2A8ME21AFSAA	6.7	10.05	3.660	6.1	DR008D0366
VFD4A8ME21ANNAA VFD4A8ME21AFNAA VFD4A8ME21ANSAA VFD4A8ME21AFSAA	10.5	15.75	2.662	4.437	DR011D0266
VFD7A5ME21ANNAA VFD7A5ME21AFNAA VFD7A5ME21ANSAA VFD7A5ME21AFSAA	17.9	26.85	1.172	1.953	DR025D0117
VFD11AME21ANNAA VFD11AME21AFNAA VFD11AME21ANSAA VFD11AME21AFSAA	26.3	39.45	0.851	1.418	DR033DP851

230V, 50–60 Hz / One-Phase - Heavy Duty

Model	Rated Current ND / HD [Arms]	Saturation ND / HD Current [Arms]	3% Input/ Output Reactor [mH]	5% Input/ Output Reactor [mH]	3% Input Reactor Delta Part #
VFD0A8ME21ANNAA VFD0A8ME21AFNAA VFD0A8ME21ANSAA VFD0A8ME21AFSAA	2.6	5.2	5.857	9.762	DR005D0585
VFD1A6ME21ANNAA VFD1A6ME21AFNAA VFD1A6ME21ANSAA VFD1A6ME21AFSAA	3.4	6.8			
VFD2A8ME21ANNAA VFD2A8ME21AFNAA VFD2A8ME21ANSAA VFD2A8ME21AFSAA	5.9	11.8	3.660	6.1	DR008D0366
VFD4A8ME21ANNAA VFD4A8ME21AFNAA VFD4A8ME21ANSAA VFD4A8ME21AFSAA	10.1	20.2	2.662	4.437	DR011D0266
VFD7A5ME21ANNAA VFD7A5ME21AFNAA VFD7A5ME21ANSAA VFD7A5ME21AFSAA	15.8	31.6	1.722	2.87	DR017D0172
VFD11AME21ANNAA VFD11AME21AFNAA VFD11AME21ANSAA VFD11AME21AFSAA	23.1	46.2	1.172	1.953	DR025D0117

230V, 50–60 Hz / Three-Phase - Normal Duty

Model	Rated Current ND / HD [Arms]	Saturation ND / HD Current [Arms]	3% Input/ Output Reactor [mH]	5% Input/ Output Reactor [mH]	3% Input Reactor Delta Part #
VFD0A8ME23ANNAA VFD0A8ME23ANSAA	1	1.5	12.681	21.135	N/A (Note)
VFD1A6ME23ANNAA VFD1A6ME23ANSAA	1.8	2.7	7.045	11.742	
VFD2A8ME23ANNAA VFD2A8ME23ANSAA	3.2	4.8	3.963	6.605	
VFD4A8ME23ANNAA VFD4A8ME23ANSAA	5	7.5	2.536	4.227	DR005A0254
VFD7A5ME23ANNAA VFD7A5ME23ANSAA	8	12	1.585	2.642	DR008A0159
VFD11AME23ANNAA VFD11AME23ANSAA	12.5	18.75	0.746	1.243	DR017AP746
VFD17AME23ANNAA VFD17AME23ANSAA	19.5	29.25	0.507	0.845	DR025AP507
VFD25AME23ANNAA VFD25AME23ANSAA	27	40.5	0.38	0.633	DR033AP320

Note: DR005A0254 is optional. It contains 3% inductance shortage.

230V, 50–60 Hz / Three-Phase - Heavy Duty

Model	Rated Current ND / HD [Arms]	Saturation ND / HD Current [Arms]	3% Input/ Output Reactor [mH]	5% Input/ Output Reactor [mH]	3% Input Reactor Delta Part #
VFD0A8ME23ANNAA VFD0A8ME23ANSAA	0.8	1.6	15.851	26.418	N/A (Note)
VFD1A6ME23ANNAA VFD1A6ME23ANSAA	1.6	3.2	7.925	13.208	
VFD2A8ME23ANNAA VFD2A8ME23ANSAA	2.8	5.6	4.529	7.548	
VFD4A8ME23ANNAA VFD4A8ME23ANSAA	4.8	9.6	2.536	4.227	DR005A0254
VFD7A5ME23ANNAA VFD7A5ME23ANSAA	7.5	15	1.585	2.642	DR008A0159
VFD11AME23ANNAA VFD11AME23ANSAA	11	22	1.152	1.92	DR011A0115
VFD17AME23ANNAA VFD17AME23ANSAA	17	34	0.746	1.243	DR017AP746
VFD25AME23ANNAA VFD25AME23ANSAA	25	50	0.507	0.845	DR025AP507

Note: DR005A0254 is optional. It contains 3% inductance shortage.

460V, 50–60 Hz / Three-Phase - Normal Duty

Model	Rated Current ND / HD [Arms]	Saturation ND / HD Current [Arms]	3% Input/ Output Reactor [mH]	5% Input/ Output Reactor [mH]	3% Input Reactor Delta Part #
VFD1A5ME43ANNAA VFD1A5ME43AFNAA VFD1A5ME43ANSAA VFD1A5ME43AFSAA	1.8	2.7	14.09	23.483	N/A (註)
VFD2A7ME43ANNAA VFD2A7ME43AFNAA VFD2A7ME43ANSAA VFD2A7ME43AFSAA	3	4.5	6.077	10.128	DR004A0607
VFD4A2ME43ANNAA VFD4A2ME43AFNAA VFD4A2ME43ANSAA VFD4A2ME43AFSAA	4.6	6.9	4.05	6.75	DR006A0405

Model	Rated Current ND / HD [Arms]	Saturation ND / HD Current [Arms]	3% Input/ Output Reactor [mH]	5% Input/ Output Reactor [mH]	3% Input Reactor Delta Part #
VFD5A5ME43ANNAA VFD5A5ME43AFNAA VFD5A5ME43ANSAA VFD5A5ME43AFSAA	6.5	9.75	2.7	4.5	DR009A0270
VFD9A0ME43ANNAA VFD9A0ME43AFNAA VFD9A0ME43ANSAA VFD9A0ME43AFSAA	10.5	15.75	2.315	3.858	DR010A0231
VFD13AME43ANNAA VFD13AME43AFNAA VFD13AME43ANSAA VFD13AME43AFSAA	15.7	23.55	1.35	2.25	DR018A0117
VFD17AME43ANNAA VFD17AME43AFNAA VFD17AME43ANSAA VFD17AME43AFSAA	20.5	30.75	1.01	1.683	DR024AP881

Note: DR003A0810 is optional. It contains 3% inductance shortage.

460V, 50–60 Hz / Three-Phase - Heavy Duty

Model	Rated Current ND / HD [Arms]	Saturation ND / HD Current [Arms]	3% Input/ Output Reactor [mH]	5% Input/ Output Reactor [mH]	3% Input Reactor Delta Part #
VFD1A5ME43ANNAA VFD1A5ME43AFNAA VFD1A5ME43ANSAA VFD1A5ME43AFSAA	1.5	3	16.907	28.178	N/A (Note)
VFD2A7ME43ANNAA VFD2A7ME43AFNAA VFD2A7ME43ANSAA VFD2A7ME43AFSAA	2.7	5.4	8.102	13.503	DR003A0810
VFD4A2ME43ANNAA VFD4A2ME43AFNAA VFD4A2ME43ANSAA VFD4A2ME43AFSAA	4.2	8.4	6.077	10.128	DR004A0607
VFD5A5ME43ANNAA VFD5A5ME43AFNAA VFD5A5ME43ANSAA VFD5A5ME43AFSAA	5.5	11	4.05	6.75	DR006A0405
VFD9A0ME43ANNAA VFD9A0ME43AFNAA VFD9A0ME43ANSAA VFD9A0ME43AFSAA	9	18	2.7	4.5	DR009A0270
VFD13AME43ANNAA VFD13AME43AFNAA VFD13AME43ANSAA VFD13AME43AFSAA	13	26	1.35	2.25	DR018A0117
VFD17AME43ANNAA VFD17AME43AFNAA VFD17AME43ANSAA VFD17AME43AFSAA	17	34	1.35	2.25	DR018A0117

Note: DR003A0810 is optional. It contains 3% inductance shortage.

AC input reactor dimension and specifications

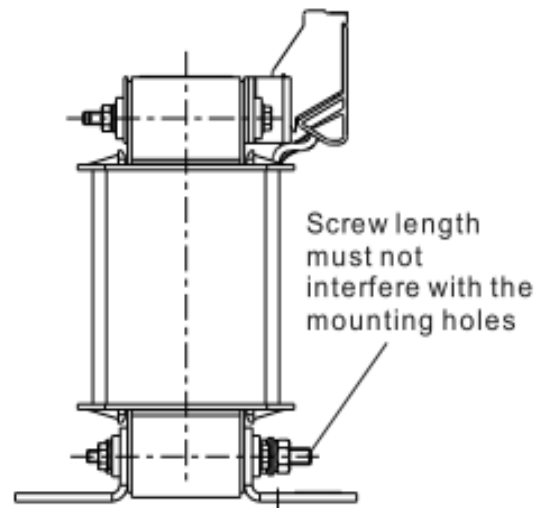
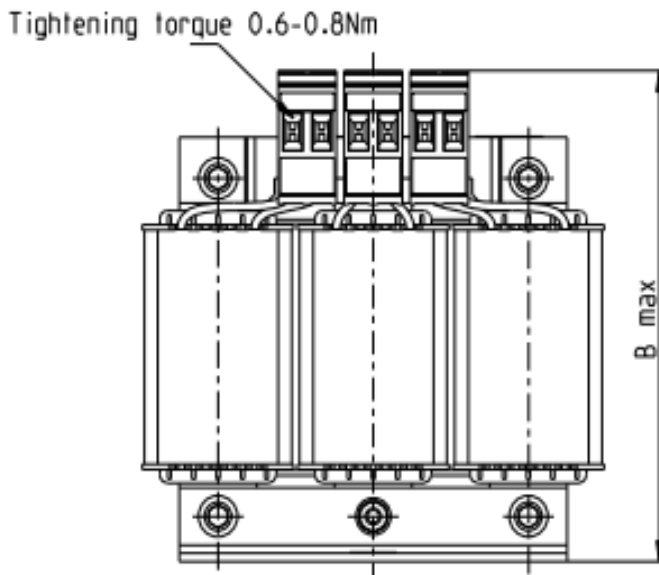
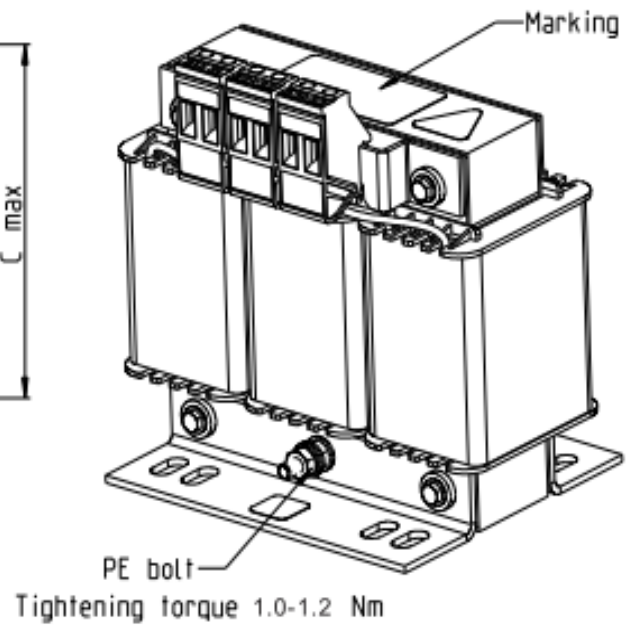
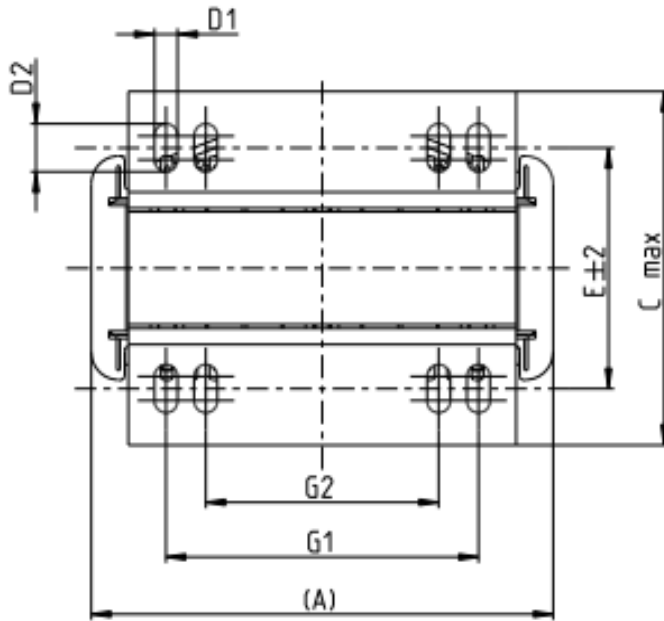

Screw Location	Torque
Terminal	5.32–7.09 kg-cm / [6.12–8.16 lb-in.] / [0.6–0.8 Nm]
PE bolt	8.86–10.63 kg-cm / [10.2–12.24 lb-in.] / [1.0–1.2 Nm]

Input AC reactor Delta part #	A	B	C	D1*D2	E	G1	G2	PE D
DR005A0254	96	100	60	6*9	42	60	40	M4
DR008A0159	120	120	88	6*12	60	80.5	60	M4
DR011A0115	120	120	88	6*12	60	80.5	60	M4
DR017AP746	120	120	93	6*12	65	80.5	60	M4
DR025AP507	150	150	112	6*12	88	107	75	M4
DR033AP320	150	150	112	6*12	88	107	75	M4

Unit: mm

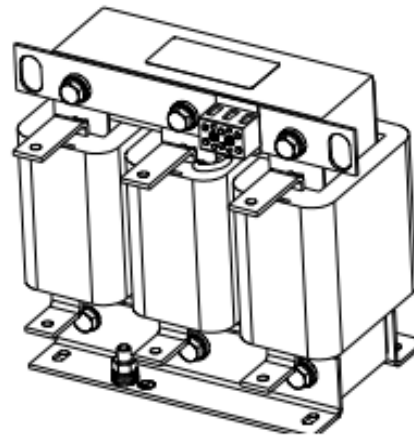
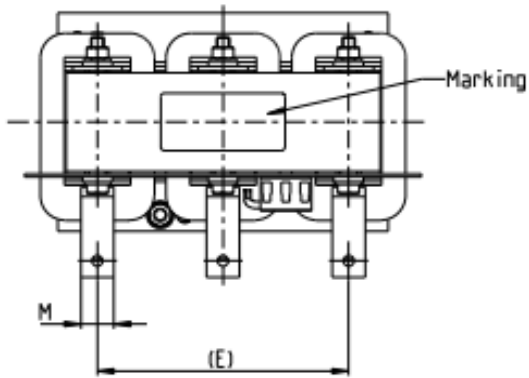
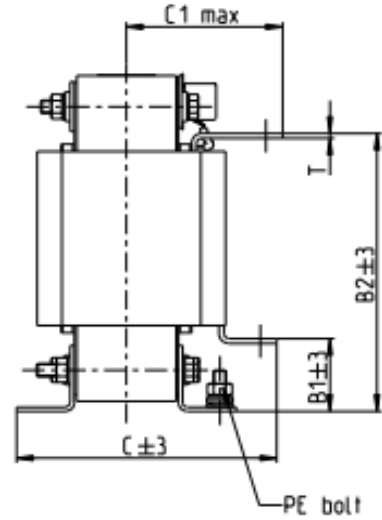
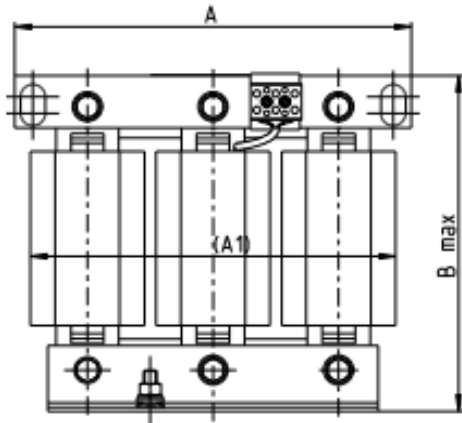
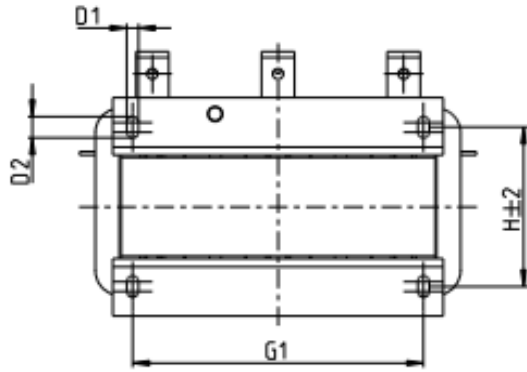

Input AC reactor Delta part #	A	A1	B	B1	B2	C	C1	D1*D2	E	G1	H	M*T	PE
DR075AP170	240	220	205	42	165	151	95	7*13	152	176	85	20*3	M8

Unit: mm

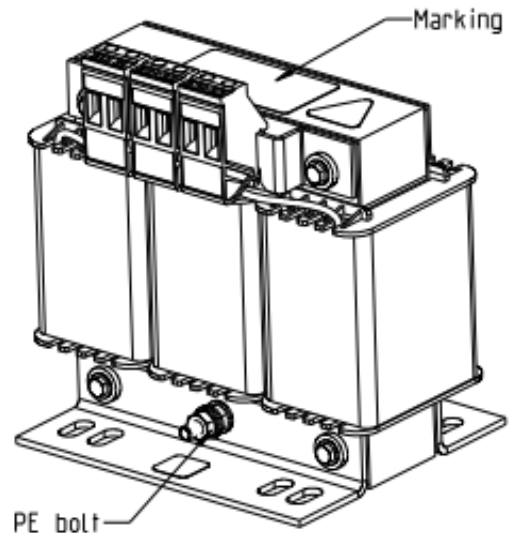
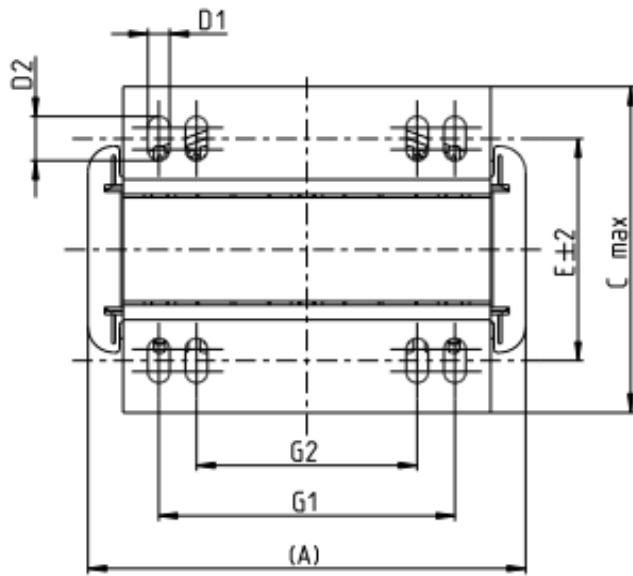

Tightening torque 1.0-1.2 Nm

Tightening torque 0.6-0.8Nm

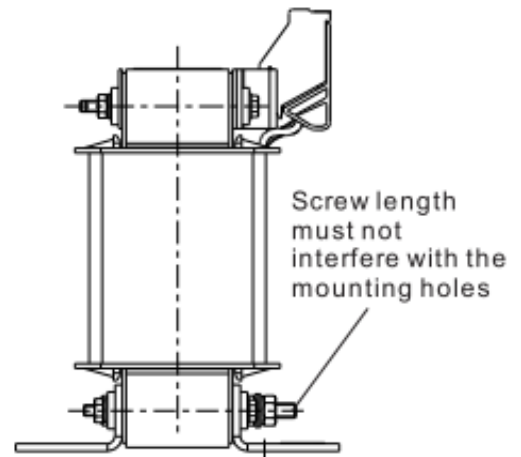
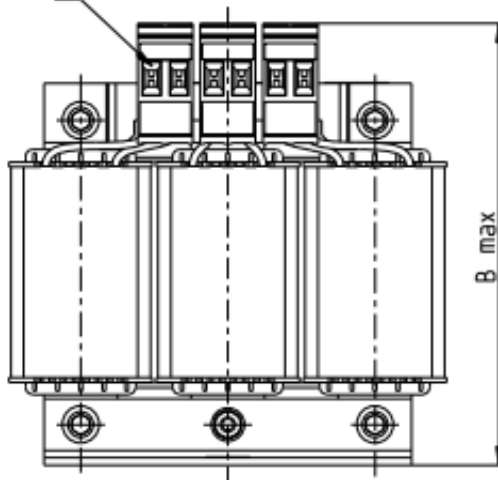

Screw Location	Torque
Terminal	5.32–7.09 kg-cm / [6.12–8.16 lb-in.] / [0.6–0.8 Nm]
PE bolt	8.86–10.63 kg-cm / [10.2–12.24 lb-in.] / [1.0–1.2 Nm]

Input AC reactor Delta part #	A	B	C	D1*D2	E	G1	G2	PE D
DR003A0810	96	100	60	6*9	42	60	40	M4
DR004A0607	120	120	88	6*12	60	80.5	60	M4
DR006A0405	120	120	88	6*12	60	805	60	M4
DR009A0270	150	150	88	6*12	74	107	75	M4
DR010A0231	150	150	112	6*12	88	107	75	M4
DR012A0202	150	150	112	6*12	88	107	75	M4
DR018A0117	150	155	112	6*12	88	107	75	M4
DR024AP881	150	155	112	6*12	88	107	75	M4

Unit: mm

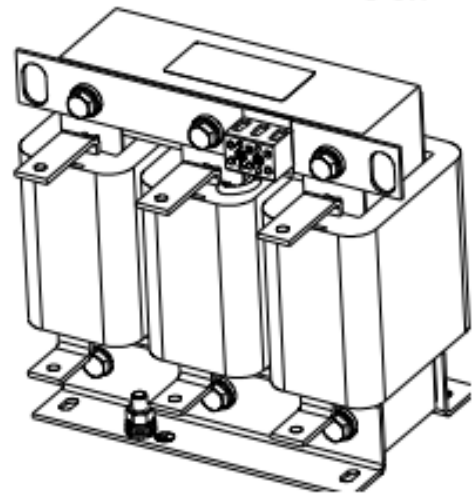
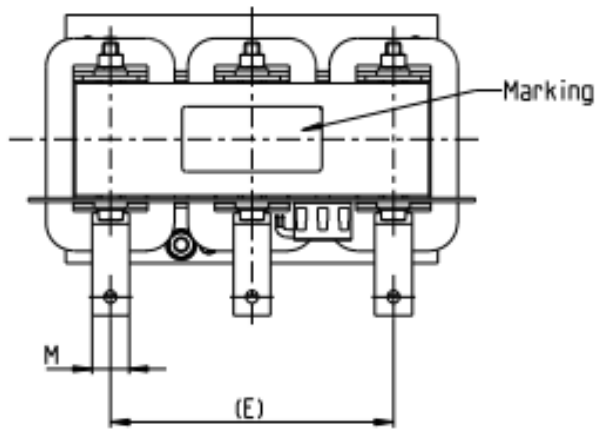
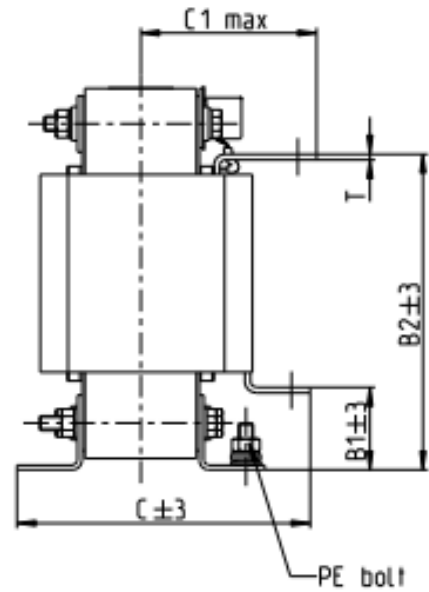
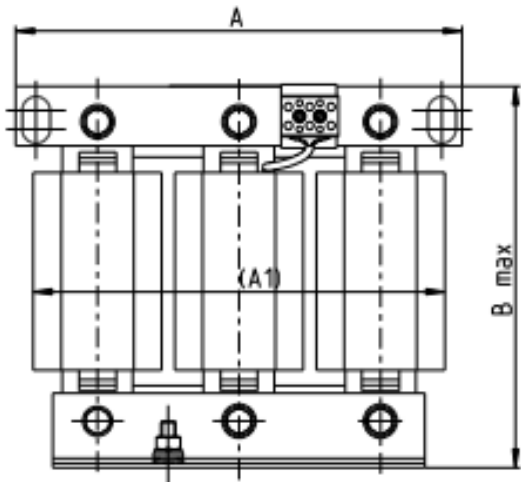
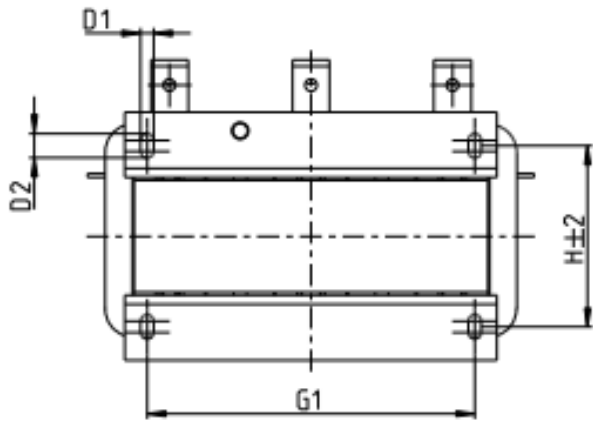

Input AC reactor Delta part #	A	A1	B	B1	B2	C	C1	D1*D2	E	G1	H	M*T	PE
DR060AP405	240	225	210	44	170	163	100	7*13	152	176	97	20*3	M8

Unit: mm

DC Reactor

A DC reactor can also improve the power factor, reduce input current, and reduce interference generated from the motor drive. A DC reactor stabilizes the DC BUS voltage. Compared to an AC input reactor, the advantages are smaller size, lower price, and lower voltage drop (lower power dissipation).

Installation

Install the DC reactor between terminals +1 and +2. Remove the jumper, shown below, before installing the DC reactor.

Note: 115V models have no DC choke.

Input: one-phase / three-phase power

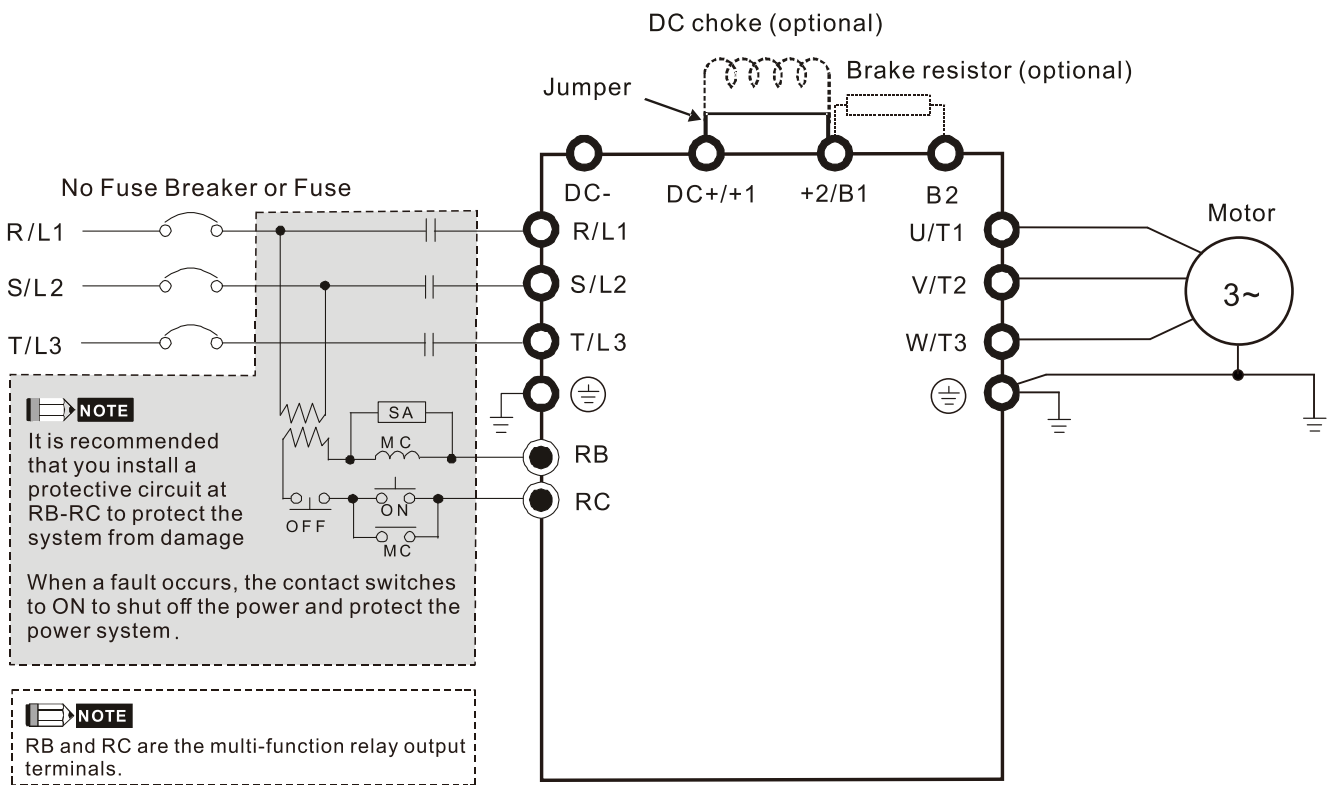

Wiring of DC reactor

115V, 50–60 Hz / One-Phase - Normal Duty

Model	Rated Current ND / HD [Arms]	Saturation ND / HD Current [Arms]	DC Reactor [mH]	DC Reactor Delta Part #
VFD0A8ME11ANNAA VFD0A8ME11ANSAA	1	1.5	14.642	N/A
VFD1A6ME11ANNAA VFD1A6ME11ANSAA	1.8	2.7	8.135	
VFD2A5ME11ANNAA VFD2A5ME11ANSAA	2.7	4.05	5.423	
VFD4A8ME11ANNAA VFD4A8ME11ANSAA	5.5	8.25	2.662	

* No recommended model

115V, 50–60 Hz / One-Phase - Heavy Duty

Model	Rated Current ND / HD [Arms]	Saturation ND / HD Current [Arms]	DC Reactor [mH]	DC Reactor Delta Part #
VFD0A8ME11ANNAA VFD0A8ME11ANSAA	1	2	14.642	N/A
VFD1A6ME11ANNAA VFD1A6ME11ANSAA	1.8	3.6	8.135	
VFD2A5ME11ANNAA VFD2A5ME11ANSAA	2.7	5.4	5.423	
VFD4A8ME11ANNAA VFD4A8ME11ANSAA	5.5	11	2.662	

230V, 50–60 Hz / One-Phase - Normal Duty

Model	Rated Current ND / HD [Arms]	Saturation ND / HD Current [Arms]	DC Reactor [mH]	DC Reactor Delta Part #
VFD0A8ME21ANNAA VFD0A8ME21AFNAA VFD0A8ME21ANSAA VFD0A8ME21AFSAA	1	1.5	29.285	N/A (Note)
VFD1A6ME21ANNAA VFD1A6ME21AFNAA VFD1A6ME21ANSAA VFD1A6ME21AFSAA	1.8	2.7	16.269	
VFD2A8ME21ANNAA VFD2A8ME21AFNAA VFD2A8ME21ANSAA VFD2A8ME21AFSAA	3.2	4.8	9.151	
VFD4A8ME21ANNAA VFD4A8ME21AFNAA VFD4A8ME21ANSAA VFD4A8ME21AFSAA	5	7.5	5.857	DR005D0585
VFD7A5ME21ANNAA VFD7A5ME21AFNAA VFD7A5ME21ANSAA VFD7A5ME21AFSAA	8.5	12.75	3.66	DR008D0366
VFD11AME21ANNAA VFD11AME21AFNAA VFD11AME21ANSAA VFD11AME21AFSAA	12.5	18.75	1.722	DR017D0172

Note: DR005D0585 is optional. It contains 3% inductance shortage.

230V, 50–60 Hz / One-Phase - Heavy Duty

Model	Rated Current ND / HD [Arms]	Saturation ND / HD Current [Arms]	DC Reactor [mH]	DC Reactor Delta Part #
VFD0A8ME21ANNAA VFD0A8ME21AFNAA VFD0A8ME21ANSAA VFD0A8ME21AFSAA	0.8	1.6	36.606	N/A (Note)
VFD1A6ME21ANNAA VFD1A6ME21AFNAA VFD1A6ME21ANSAA VFD1A6ME21AFSAA	1.6	3.2	18.303	
VFD2A8ME21ANNAA VFD2A8ME21AFNAA VFD2A8ME21ANSAA VFD2A8ME21AFSAA	2.8	5.6	10.459	
VFD4A8ME21ANNAA VFD4A8ME21AFNAA VFD4A8ME21ANSAA VFD4A8ME21AFSAA	4.8	9.6	5.857	DR005D0585

Model	Rated Current ND / HD [Arms]	Saturation ND / HD Current [Arms]	DC Reactor [mH]	DC Reactor Delta Part #
VFD7A5ME21ANNAA VFD7A5ME21AFNAA VFD7A5ME21ANSAA VFD7A5ME21AFSAA	7.5	15	3.66	DR008D0366
VFD11AME21ANNAA VFD11AME21AFNAA VFD11AME21ANSAA VFD11AME21AFSAA	11	22	2.662	DR011D0266

Note: DR005D0585 is optional. It contains 3% inductance shortage.

230V, 50–60 Hz / Three-Phase - Normal Duty

Model	Rated Current ND / HD [Arms]	Saturation ND / HD Current [Arms]	DC Reactor [mH]	DC Reactor Delta Part #
VFD0A8ME23ANNAA VFD0A8ME23ANSAA	1	1.5	29.285	N/A (Note)
VFD1A6ME23ANNAA VFD1A6ME23ANSAA	1.8	2.7	16.269	
VFD2A8ME23ANNAA VFD2A8ME23ANSAA	3.2	4.8	9.151	
VFD4A8ME23ANNAA VFD4A8ME23ANSAA	5	7.5	5.857	DR005D0585
VFD7A5ME23ANNAA VFD7A5ME23ANSAA	8	12	3.66	DR008D0366
VFD11AME23ANNAA VFD11AME23ANSAA	12.5	18.75	1.722	DR017D0172
VFD17AME23ANNAA VFD17AME23ANSAA	19.5	29.25	1.172	DR025D0117
VFD25AME23ANNAA VFD25AME23ANSAA	27	40.5	0.851	DR033DP851

Note: DR005D0585 is optional. It contains 3% inductance shortage.

230V, 50–60 Hz / Three-Phase - Heavy Duty

Model	Rated Current ND / HD [Arms]	Saturation ND / HD Current [Arms]	DC Reactor [mH]	DC Reactor Delta Part #
VFD0A8ME23ANNAA VFD0A8ME23ANSAA	0.8	1.6	36.606	N/A (Note)
VFD1A6ME23ANNAA VFD1A6ME23ANSAA	1.6	3.2	18.303	
VFD2A8ME23ANNAA VFD2A8ME23ANSAA	2.8	5.6	10.459	
VFD4A8ME23ANNAA VFD4A8ME23ANSAA	4.8	9.6	5.857	DR005D0585
VFD7A5ME23ANNAA VFD7A5ME23ANSAA	7.5	15	3.66	DR008D0366
VFD11AME23ANNAA VFD11AME23ANSAA	11	22	2.662	DR011D0266
VFD17AME23ANNAA VFD17AME23ANSAA	17	34	1.722	DR017D0172
VFD25AME23ANNAA VFD25AME23ANSAA	25	50	1.172	DR025D0117

Note: DR005D0585 is optional. It contains 3% inductance shortage.

460V, 50–60 Hz / Three-Phase - Normal Duty

Model	Rated Current ND / HD [Arms]	Saturation ND / HD Current [Arms]	DC Reactor [mH]	DC Reactor Delta Part #
VFD1A5ME43ANNAA VFD1A5ME43AFNAA VFD1A5ME43ANSAA VFD1A5ME43AFSAA	1.8	2.7	32.538	N/A (Note)

Model	Rated Current ND / HD [Arms]	Saturation ND / HD Current [Arms]	DC Reactor [mH]	DC Reactor Delta Part #
VFD2A7ME43ANNAA VFD2A7ME43AFNAA VFD2A7ME43ANSAA VFD2A7ME43AFSAA	3	4.5	14.031	DR004D1403
VFD4A2ME43ANNAA VFD4A2ME43AFNAA VFD4A2ME43ANSAA VFD4A2ME43AFSAA	4.6	6.9	9.355	DR006D0935
VFD5A5ME43ANNAA VFD5A5ME43AFNAA VFD5A5ME43ANSAA VFD5A5ME43AFSAA	6.5	9.75	6.236	DR009D0623
VFD9A0ME43ANNAA VFD9A0ME43AFNAA VFD9A0ME43ANSAA VFD9A0ME43AFSAA	10.5	15.75	5.345	DR010D0534
VFD13AME43ANNAA VFD13AME43AFNAA VFD13AME43ANSAA VFD13AME43AFSAA	15.7	23.55	3.119	DR018D0311
VFD17AME43ANNAA VFD17AME43AFNAA VFD17AME43ANSAA VFD17AME43AFSAA	20.5	30.75	2.338	DR024D0233

Note: DR005D0585 is optional. It contains 3% inductance shortage.

460V, 50–60 Hz / Three-Phase - Heavy Duty

Model	Rated Current ND / HD [Arms]	Saturation ND / HD Current [Arms]	DC Reactor [mH]	DC Reactor Delta Part #
VFD1A5ME43ANNAA VFD1A5ME43AFNAA VFD1A5ME43ANSAA VFD1A5ME43AFSAA	1.5	3	39.046	N/A (Note)
VFD2A7ME43ANNAA VFD2A7ME43AFNAA VFD2A7ME43ANSAA VFD2A7ME43AFSAA	2.7	5.4	18.709	DR003D1870
VFD4A2ME43ANNAA VFD4A2ME43AFNAA VFD4A2ME43ANSAA VFD4A2ME43AFSAA	4.2	8.4	14.031	DR004D1403
VFD5A5ME43ANNAA VFD5A5ME43AFNAA VFD5A5ME43ANSAA VFD5A5ME43AFSAA	5.5	11	9.355	DR006D0935
VFD9A0ME43ANNAA VFD9A0ME43AFNAA VFD9A0ME43ANSAA VFD9A0ME43AFSAA	9	18	6.236	DR009D0623
VFD13AME43ANNAA VFD13AME43AFNAA VFD13AME43ANSAA VFD13AME43AFSAA	13	26	3.119	DR018D0311
VFD17AME43ANNAA VFD17AME43AFNAA VFD17AME43ANSAA VFD17AME43AFSAA	17	34		

Note: DR005D0585 is optional. It contains 3% inductance shortage.

DC reactor dimension and specifications

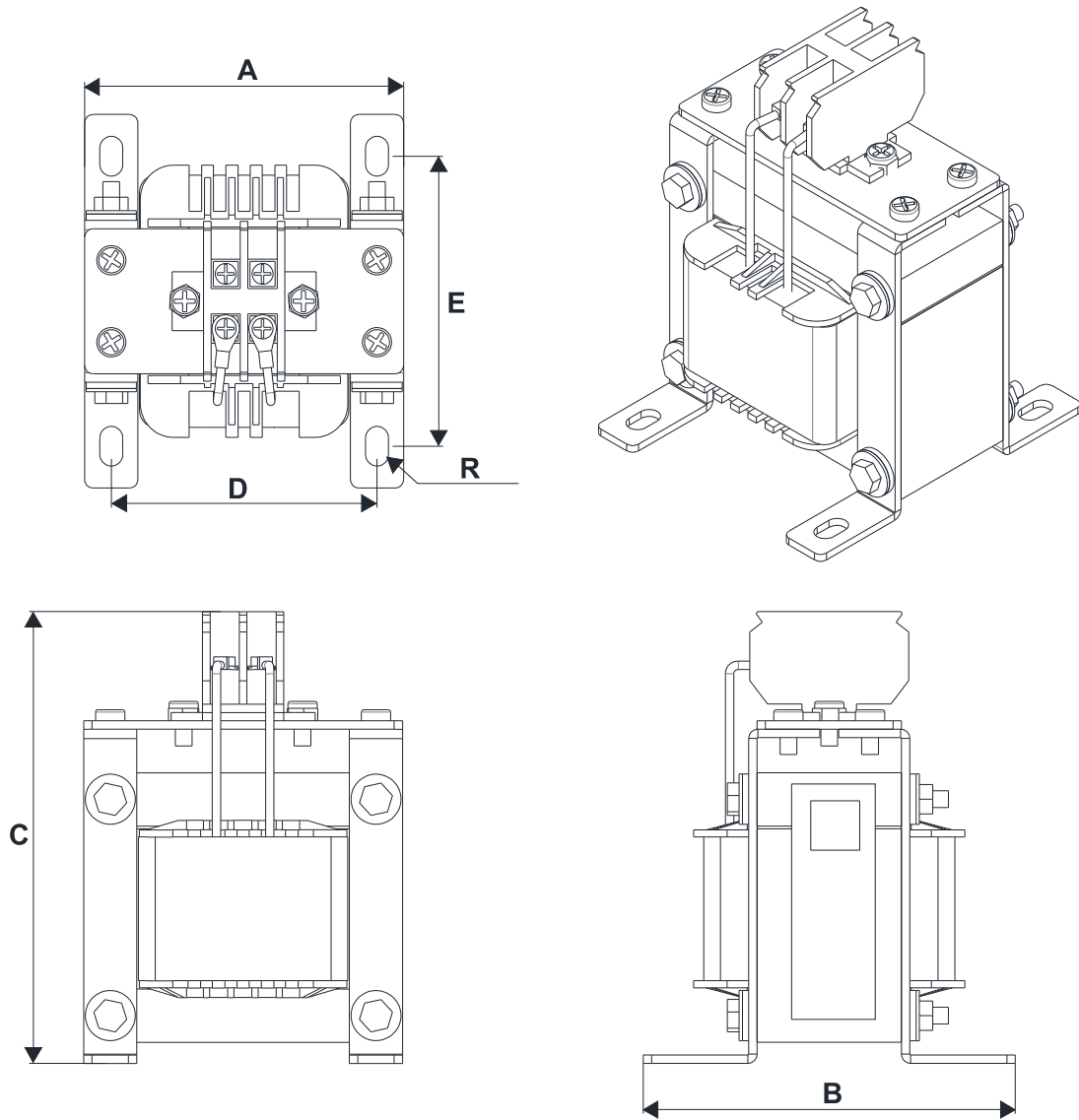

DC reactor Delta Part #	Rated Current [Arms]	Saturation current [Arms]	DC reactor [mH]	A [mm]	B [mm]	C [mm]	D [mm]	E [mm]	Dimension [mm]
DR005D0585	5	8.64	5.857	79	78	112	64±2	56±2	9.5*5.5
DR008D0366	8	12.78	3.660	79	78	112	64±2	56±2	9.5*5.5
DR011D0266	11	18	2.662	79	92	112	64±2	69.5±2	9.5*5.5
DR017D0172	17	28.8	1.722	79	112	112	64±2	89.5±2	9.5*5.5
DR025D0117	25	43.2	1.172	99	105	128	79±2	82.5±2	9.5*5.5
DR003D1870	3	5.22	18.709	79	78	112	64±2	56±2	9.5*5.5
DR004D1403	4	6.84	14.031	79	92	112	64±2	69.5±2	9.5*5.5
DR006D0935	6	10.26	9.355	79	92	112	64±2	69.5±2	9.5*5.5
DR009D0623	9	14.58	6.236	79	112	112	64±2	89.5±2	9.5*5.5
DR010D0534	10.5	17.1	5.345	99	93	128	79±2	70±2	9.5*5.5
DR012D0467	12	19.8	4.677	99	105	128	79±2	82.5±2	9.5*5.5
DR018D0311	18	30.6	3.119	117	110	144	95±2	87±2	10*6.5
DR024D0233	24	41.4	2.338	117	120	144	95±2	97±2	10*6.5

Length of the Motor Cable

1. Leakage current affects the motor and remedies

Due to larger parasitic capacitances in longer motor cables, longer cables increase the leakage current. This can activate the over-current protection and display the incorrect current. In the worst case, it can damage the drive.

If more than one motor is connected to the AC motor drive, the total motor cable length is the sum of the cable length from the AC motor drive to each motor.

For 460V series AC motor drives, when an overload relay is installed between the drive and the motor to protect the motor from overheating, the connecting cable must be shorter than 50 m.

However, the overload relay could still malfunction. To prevent this, install an AC output reactor (optional) to the drive and/or lower the carrier frequency setting (Pr.00-17).

2. Surge voltage affects the motor and remedies

When a PWM signal from an AC motor drive drives the motor, the motor terminals can easily experience surge voltages (dv/dt) due to IGBT switching and cable capacitance. When the motor cable is very long (especially for the 460V series), surge voltages (dv/dt) may reduce motor insulation quality. To prevent this, follow the rules listed below.

- a. Use a motor with enhanced insulation.
- b. Connect an output reactor (optional) to the output terminals of the AC motor drive.
- c. Reduce the motor cable length to the values in the table below.

The suggested motor shielded cable length in the following table complies with IEC 60034-17, which is suitable for motors with a rated voltage $\leq 500 V_{AC}$ and with an insulation level of $\geq 1.35 kV_{P-P}$.

115V One-phase Model	Without AC reactor		With AC reactor	
	Shielded Cable [meter]	Non-shielded cable [meter]	Shielded Cable [meter]	Non-shielded cable [meter]
VFD0A8ME11ANNAA VFD0A8ME11ANSAA	50	75	75	115
VFD1A6ME11ANNAA VFD1A6ME11ANSAA				
VFD2A5ME11ANNAA VFD2A5ME11ANSAA				
VFD4A8ME11ANNAA VFD4A8ME11ANSAA				

230V One-phase Model	Without AC reactor		With AC reactor	
	Shielded Cable [meter]	Non-shielded cable [meter]	Shielded Cable [meter]	Non-shielded cable [meter]
VFD0A8ME21ANNAA VFD0A8ME21AFNAA VFD0A8ME21ANSAA VFD0A8ME21AFSAA	50	75	75	115
VFD1A6ME21ANNAA VFD1A6ME21AFNAA VFD1A6ME21ANSAA VFD1A6ME21AFSAA				

230V One-phase Model	Without AC reactor		With AC reactor	
	Shielded Cable [meter]	Non-shielded cable [meter]	Shielded Cable [meter]	Non-shielded cable [meter]
VFD2A8ME21ANNAA VFD2A8ME21AFNAA VFD2A8ME21ANSAA VFD2A8ME21AFSAA	50	75	75	115
VFD4A8ME21ANNAA VFD4A8ME21AFNAA VFD4A8ME21ANSAA VFD4A8ME21AFSAA				
VFD7A5ME21ANNAA VFD7A5ME21AFNAA VFD7A5ME21ANSAA VFD7A5ME21AFSAA				
VFD11AME21ANNAA VFD11AME21AFNAA VFD11AME21ANSAA VFD11AME21AFSAA				

230V Three-phase Model	Without AC reactor		With AC reactor	
	Shielded Cable [meter]	Non-shielded cable [meter]	Shielded Cable [meter]	Non-shielded cable [meter]
VFD0A8ME23ANNAA VFD0A8ME23ANSAA	50	75	75	115
VFD1A6ME23ANNAA VFD1A6ME23ANSAA				
VFD2A8ME23ANNAA VFD2A8ME23ANSAA				
VFD4A8ME23ANNAA VFD4A8ME23ANSAA				
VFD7A5ME23ANNAA VFD7A5ME23ANSAA				
VFD11AME23ANNAA VFD11AME23ANSAA				
VFD17AME23ANNAA VFD17AME23ANSAA				
VFD25AME23ANNAA VFD25AME23ANSAA				

460V Three-phase Model	Without AC reactor		With AC reactor	
	Shielded Cable [meter]	Non-shielded cable [meter]	Shielded Cable [meter]	Non-shielded Cable [meter]
VFD1A5ME43ANNAA VFD1A5ME43AFNAA VFD1A5ME43ANSAA VFD1A5ME43AFSAA	35	50	50	90
VFD2A7ME43ANNAA VFD2A7ME43AFNAA VFD2A7ME43ANSAA VFD2A7ME43AFSAA				
VFD4A2ME43ANNAA VFD4A2ME43AFNAA VFD4A2ME43ANSAA VFD4A2ME43AFSAA	50	75	75	115
VFD5A5ME43ANNAA VFD5A5ME43AFNAA VFD5A5ME43ANSAA VFD5A5ME43AFSAA				

460V Three-phase Model	Without AC reactor		With AC reactor	
	Shielded Cable [meter]	Non-shielded cable [meter]	Shielded Cable [meter]	Non-shielded Cable [meter]
VFD9A0ME43ANNAA VFD9A0ME43AFNAA VFD9A0ME43ANSAA VFD9A0ME43AFSAA	50	75	75	115
VFD13AME43ANNAA VFD13AME43AFNAA VFD13AME43ANSAA VFD13AME43AFSAA				
VFD17AME43ANNAA VFD17AME43AFNAA VFD17AME43ANSAA VFD17AME43AFSAA	100	150	150	225

AC Output Reactor

GF (Ground Fault), OC (Over-current) and voltage over-shoot easily occur when the drive is applied for long output conduit. GF and OC may cause the drive to malfunction due to the drive’s self-protective mechanism; voltage over-shoot causes damage to motor insulation.

Too long an output conduit may trigger larger parasitic capacitances to the ground and higher three-phase output common mode current, further making the drive activate the GF protection. Moreover, the larger line-to-line and line-to-ground parasitic capacitances lead to inrush current, making the drive’s over-outputted current enable OC protection. To prevent this, connecting a reactor to the output terminals of the drive can usually increase high frequency resistance and reduce the current generated from parasitic capacitances.

115V, 50–60 Hz / One-Phase - Normal Duty

Model	Rated Current ND / HD [Arms]	Saturation ND / HD Current [Arms]	3% Input/ Output Reactor [mH]	5% Input/ Output Reactor [mH]	3% Input Reactor Delta Part #
VFD0A8ME11ANNAA VFD0A8ME11ANSAA	1	1.5	6.340	10.567	N/A
VFD1A6ME11ANNAA VFD1A6ME11ANSAA	1.8	2.7	3.522	5.87	
VFD2A5ME11ANNAA VFD2A5ME11ANSAA	2.7	4.05	2.348	3.913	
VFD4A8ME11ANNAA VFD4A8ME11ANSAA	5.5	8.25	1.153	1.922	

* No recommended model

115V, 50–60 Hz / One-Phase - Heavy Duty

Model	Rated Current ND / HD [Arms]	Saturation ND / HD Current [Arms]	3% Input/ Output Reactor [mH]	5% Input/ Output Reactor [mH]	3% Input Reactor Delta Part #
VFD0A8ME11ANNAA VFD0A8ME11ANSAA	1	2	6.340	10.567	N/A
VFD1A6ME11ANNAA VFD1A6ME11ANSAA	1.8	3.6	3.522	5.87	
VFD2A5ME11ANNAA VFD2A5ME11ANSAA	2.7	5.4	2.348	3.913	
VFD4A8ME11ANNAA VFD4A8ME11ANSAA	5.5	11	1.153	1.922	

* No recommended model

230V, 50–60 Hz / One-Phase - Normal Duty

Model	Rated Current ND / HD [Arms]	Saturation ND / HD Current [Arms]	3% Input/ Output Reactor [mH]	5% Input/ Output Reactor [mH]	3% Input Reactor Delta Part #
VFD0A8ME21ANNAA VFD0A8ME21AFNAA VFD0A8ME21ANSAA VFD0A8ME21AFSAA	1	1.5	12.681	21.135	N/A (Note)
VFD1A6ME21ANNAA VFD1A6ME21AFNAA VFD1A6ME21ANSAA VFD1A6ME21AFSAA	1.8	2.7	7.045	11.742	
VFD2A8ME21ANNAA VFD2A8ME21AFNAA VFD2A8ME21ANSAA VFD2A8ME21AFSAA	3.2	4.8	3.963	6.605	
VFD4A8ME21ANNAA VFD4A8ME21AFNAA VFD4A8ME21ANSAA VFD4A8ME21AFSAA	5	7.5	2.536	4.227	DR005L0254
VFD7A5ME21ANNAA VFD7A5ME21AFNAA VFD7A5ME21ANSAA VFD7A5ME21AFSAA	8.5	12.75	1.585	2.642	DR008L0159
VFD11AME21ANNAA VFD11AME21AFNAA VFD11AME21ANSAA VFD11AME21AFSAA	12.5	18.75	0.746	1.243	DR017LP746

Note: DR005L0254 is optional. It contains 3% inductance shortage.

230V, 50–60 Hz / One-Phase - Heavy Duty

Model	Rated Current ND / HD [Arms]	Saturation ND / HD Current [Arms]	3% Input/ Output Reactor [mH]	5% Input/ Output Reactor [mH]	3% Input Reactor Delta Part #
VFD0A8ME21ANNAA VFD0A8ME21AFNAA VFD0A8ME21ANSAA VFD0A8ME21AFSAA	0.8	1.6	15.851	26.418	N/A (Note)
VFD1A6ME21ANNAA VFD1A6ME21AFNAA VFD1A6ME21ANSAA VFD1A6ME21AFSAA	1.6	3.2	7.925	13.208	
VFD2A8ME21ANNAA VFD2A8ME21AFNAA VFD2A8ME21ANSAA VFD2A8ME21AFSAA	2.8	5.6	4.529	7.548	
VFD4A8ME21ANNAA VFD4A8ME21AFNAA VFD4A8ME21ANSAA VFD4A8ME21AFSAA	4.8	9.6	2.536	4.227	DR005L0254
VFD7A5ME21ANNAA VFD7A5ME21AFNAA VFD7A5ME21ANSAA VFD7A5ME21AFSAA	7.5	15	1.585	2.642	DR008L0159
VFD11AME21ANNAA VFD11AME21AFNAA VFD11AME21ANSAA VFD11AME21AFSAA	11	22	1.152	1.92	DR011L0115

Note: DR005L0254 is optional. It contains 3% inductance shortage.

230V, 50–60 Hz / Three-Phase - Normal Duty

Model	Rated Current ND / HD [Arms]	Saturation ND / HD Current [Arms]	3% Input/ Output Reactor [mH]	5% Input/ Output Reactor [mH]	3% Input Reactor Delta Part #
VFD0A8ME23ANNAA VFD0A8ME23ANSAA	1	1.5	12.681	21.135	N/A (Note)
VFD1A6ME23ANNAA VFD1A6ME23ANSAA	1.8	2.7	7.045	11.742	
VFD2A8ME23ANNAA VFD2A8ME23ANSAA	3.2	4.8	3.963	6.605	
VFD4A8ME23ANNAA VFD4A8ME23ANSAA	5	7.5	2.536	4.227	DR005L0254
VFD7A5ME23ANNAA VFD7A5ME23ANSAA	8	12	1.585	2.642	DR008L0159
VFD11AME23ANNAA VFD11AME23ANSAA	12.5	18.75	0.746	1.243	DR017LP746
VFD17AME23ANNAA VFD17AME23ANSAA	19.5	29.25	0.507	0.845	DR025LP507
VFD25AME23ANNAA VFD25AME23ANSAA	27	40.5	0.38	0.633	DR033LP320

Note: DR005L0254 is optional. It contains 3% inductance shortage.

230V, 50–60 Hz / Three-Phase - Heavy Duty

Model	Rated Current ND / HD [Arms]	Saturation ND / HD Current [Arms]	3% Input/ Output Reactor [mH]	5% Input/ Output Reactor [mH]	3% Input Reactor Delta Part #
VFD0A8ME23ANNAA VFD0A8ME23ANSAA	0.8	1.6	15.851	26.418	N/A (Note)
VFD1A6ME23ANNAA VFD1A6ME23ANSAA	1.6	3.2	7.925	13.208	
VFD2A8ME23ANNAA VFD2A8ME23ANSAA	2.8	5.6	4.529	7.548	
VFD4A8ME23ANNAA VFD4A8ME23ANSAA	4.8	9.6	2.536	4.227	DR005L0254
VFD7A5ME23ANNAA VFD7A5ME23ANSAA	7.5	15	1.585	2.642	DR008L0159
VFD11AME23ANNAA VFD11AME23ANSAA	11	22	1.152	1.92	DR011L0115
VFD17AME23ANNAA VFD17AME23ANSAA	17	34	0.746	1.243	DR017LP746
VFD25AME23ANNAA VFD25AME23ANSAA	25	50	0.507	0.845	DR025LP507

Note: DR005L0254 is optional. It contains 3% inductance shortage.

460V, 50–60 Hz / Three-Phase - Normal Duty

Model	Rated Current ND / HD [Arms]	Saturation ND / HD Current [Arms]	3% Input/ Output Reactor [mH]	5% Input/ Output Reactor [mH]	3% Input Reactor Delta Part #
VFD1A5ME43ANNAA VFD1A5ME43AFNAA VFD1A5ME43ANSAA VFD1A5ME43AFSAA	1.8	2.7	14.09	23.483	N/A (Note)
VFD2A7ME43ANNAA VFD2A7ME43AFNAA VFD2A7ME43ANSAA VFD2A7ME43AFSAA	3	4.5	6.077	10.128	DR004L0607
VFD4A2ME43ANNAA VFD4A2ME43AFNAA VFD4A2ME43ANSAA VFD4A2ME43AFSAA	4.6	6.9	4.05	6.75	DR006L0405
VFD5A5ME43ANNAA VFD5A5ME43AFNAA VFD5A5ME43ANSAA VFD5A5ME43AFSAA	6.5	9.75	2.7	4.5	DR009L0270

Model	Rated Current ND / HD [Arms]	Saturation ND / HD Current [Arms]	3% Input/ Output Reactor [mH]	5% Input/ Output Reactor [mH]	3% Input Reactor Delta Part #
VFD9A0ME43ANNAA VFD9A0ME43AFNAA VFD9A0ME43ANSAA VFD9A0ME43AFSAA	10.5	15.75	2.315	3.858	DR010L0231
VFD13AME43ANNAA VFD13AME43AFNAA VFD13AME43ANSAA VFD13AME43AFSAA	15.7	23.55	1.35	2.25	DR018L0117
VFD17AME43ANNAA VFD17AME43AFNAA VFD17AME43ANSAA VFD17AME43AFSAA	20.5	30.75	1.01	1.683	DR024LP881

Note: DR003L0810 is optional. It contains 3% inductance shortage.

460V, 50–60 Hz / Three-Phase - Heavy Duty

Model	Rated Current ND / HD [Arms]	Saturation ND / HD Current [Arms]	3% Input/ Output Reactor [mH]	5% Input/ Output Reactor [mH]	3% Input Reactor Delta Part #
VFD1A5ME43ANNAA VFD1A5ME43AFNAA VFD1A5ME43ANSAA VFD1A5ME43AFSAA	1.5	3	16.907	28.178	N/A (Note)
VFD2A7ME43ANNAA VFD2A7ME43AFNAA VFD2A7ME43ANSAA VFD2A7ME43AFSAA	2.7	5.4	8.102	13.503	DR003L0810
VFD4A2ME43ANNAA VFD4A2ME43AFNAA VFD4A2ME43ANSAA VFD4A2ME43AFSAA	4.2	8.4	6.077	10.128	DR004L0607
VFD5A5ME43ANNAA VFD5A5ME43AFNAA VFD5A5ME43ANSAA VFD5A5ME43AFSAA	5.5	11	4.05	6.75	DR006L0405
VFD9A0ME43ANNAA VFD9A0ME43AFNAA VFD9A0ME43ANSAA VFD9A0ME43AFSAA	9	18	2.7	4.5	DR009L0270
VFD13AME43ANNAA VFD13AME43AFNAA VFD13AME43ANSAA VFD13AME43AFSAA	13	26	1.35	2.25	DR018L0117
VFD17AME43ANNAA VFD17AME43AFNAA VFD17AME43ANSAA VFD17AME43AFSAA	17	34	1.35	2.25	DR018L0117

Note: DR003L0810 is optional. It contains 3% inductance shortage.

ME300 230V Model Output Reactor & Max. Cable Length								
230V Model	kW	HP	Rated Current [Arms]		Without Output Choke		With Output Choke	
			Normal Duty	Heavy Duty	Shielded Cable [meter]	Non-shielded Cable [meter]	Shielded Cable [meter]	Non-shielded Cable [meter]
VFD0A8ME21ANNAA VFD0A8ME21AFNAA VFD0A8ME21ANSAA VFD0A8ME21AFSAA VFD0A8ME23ANNAA VFD0A8ME23ANSAA	0.1	0.125	1	0.8	50	75	75	115
VFD1A6ME21ANNAA VFD1A6ME21AFNAA VFD1A6ME21ANSAA VFD1A6ME21AFSAA VFD1A6ME23ANNAA VFD1A6ME23ANSAA	0.2	0.25	1.8	1.6				
VFD2A8ME21ANNAA VFD2A8ME21AFNAA VFD2A8ME21ANSAA VFD2A8ME21AFSAA VFD2A8ME23ANNAA VFD2A8ME23ANSAA	0.4	0.5	3.2	2.8				
VFD4A8ME21ANNAA VFD4A8ME21AFNAA VFD4A8ME21ANSAA VFD4A8ME21AFSAA VFD4A8ME23ANNAA VFD4A8ME23ANSAA	0.75	1	5	4.8				
VFD7A5ME21ANNAA VFD7A5ME21AFNAA VFD7A5ME21ANSAA VFD7A5ME21AFSAA VFD7A5ME23ANNAA VFD7A5ME23ANSAA	1.5	2	8	7.5				
VFD11AME21ANNAA VFD11AME21AFNAA VFD11AME21ANSAA VFD11AME21AFSAA VFD11AME23ANNAA VFD11AME23ANSAA	2.2	3	12.5	11				
VFD17AME23ANNAA VFD17AME23ANSAA	3.7	5	19.5	17				
VFD25AME23ANNAA VFD25AME23ANSAA	5.5	7.5	27	25				

ME300 460V Model Output Reactor & Max. Cable Length								
460V Model	kW	HP	Rated Current [Arms]		Without Output Choke		With Output Choke	
			Normal Duty	Heavy Duty	Shielded Cable [meter]	Non-shielded Cable [meter]	Shielded Cable [meter]	Non-shielded Cable [meter]
VFD1A5ME43ANNAA VFD1A5ME43AFNAA VFD1A5ME43ANSAA VFD1A5ME43AFSAA	0.4	0.5	1.8	1.5	50	75	75	115
VFD2A7ME43ANNAA VFD2A7ME43AFNAA VFD2A7ME43ANSAA VFD2A7ME43AFSAA	0.75	1	3	2.7				
VFD4A2ME43ANNAA VFD4A2ME43AFNAA VFD4A2ME43ANSAA VFD4A2ME43AFSAA	1.5	2	4.6	4.2				
VFD5A5ME43ANNAA VFD5A5ME43AFNAA VFD5A5ME43ANSAA VFD5A5ME43AFSAA	2.2	3	6.5	5.5				
VFD9A0ME43ANNAA VFD9A0ME43AFNAA VFD9A0ME43ANSAA VFD9A0ME43AFSAA	3.7	5	10.5	9				
VFD13AME43ANNAA VFD13AME43AFNAA VFD13AME43ANSAA VFD13AME43AFSAA	5.5	7.5	15.7	13				
VFD17AME43ANNAA VFD17AME43AFNAA VFD17AME43ANSAA VFD17AME43AFSAA	7.5	10	20.5	17	100	150	150	225

7-5 Zero Phase Reactors

You can also suppress interference by installing a zero phase reactor at the main input or the motor output of the drive, depending on the location of the interference. Delta provides two types of zero phase reactors to solve interference problems.

A. Casing with mechanical fixed part

This solution is for the main input/motor output side and can withstand higher loading, and be used at higher frequencies. You can get higher impedance by increasing the number of turns.

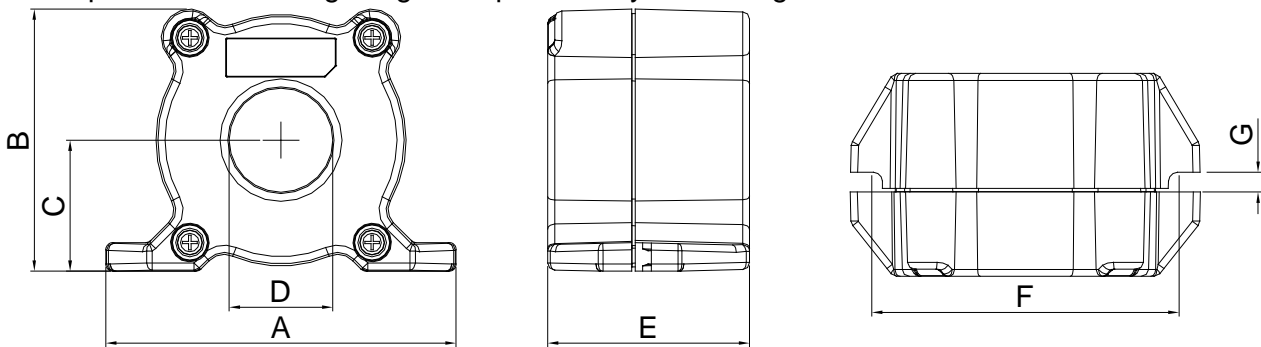

Model	A	B	C	D	E	F	G(Ø)	To use w/
RF008X00A	99	73	36.5	29	56.5	86	5.5	Motor cable

Unit: mm

B. Casing without mechanical fixed part

This solution has higher performance: high initial magnetic permeability, high saturation induction density, low iron loss and perfect temperature characteristic. If the zero phase reactor does not need to be fixed mechanically, use this solution.

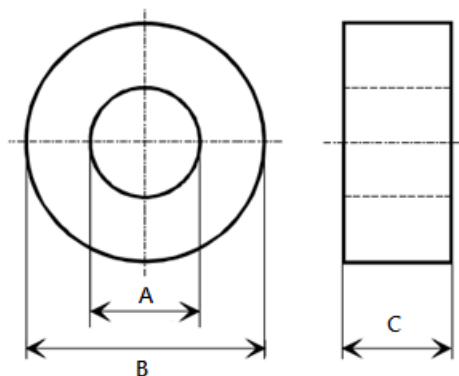

Model	A	B	C	To use w/
T60006L2040W453	22.5	43.1	18.5	Motor cable
T60006L2050W565	36.3	53.5	23.4	Motor cable
T60004L2016W620	10.7	17.8	8.0	Motor cable
T60004L2025W622	17.5	27.3	12.3	Motor cable

Unit: mm

Installation

During installation, pass the cable through at least one zero phase reactor.

Use a suitable cable type (insulation class and wire section) so that the cable passes easily through the zero phase reactor. Do not pass the grounding cable through the zero phase reactor; only pass the motor wire through the zero phase reactor.

With longer motor cables the zero phase reactor can effectively reduce interference at the motor output. Install the zero phase reactor as close to the output of the drive as possible. Figure A shows the installation diagram for a single turn zero phase reactor. If the wire diameter allows several turns, Figure B shows the installation of a multi-turn zero phase reactor. The more turns, the better the noise suppression effect.

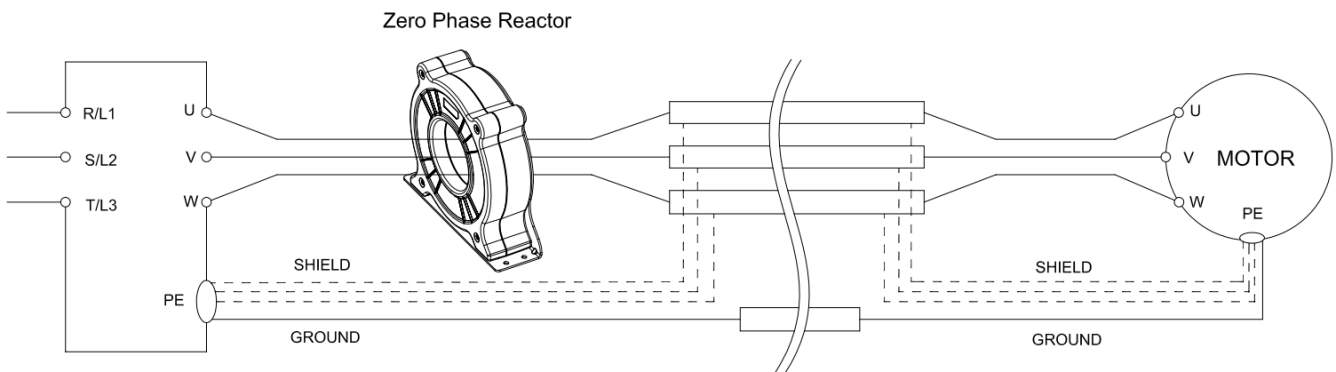

Figure A: Single turn wiring diagram for a shielding wire with a zero phase reactor

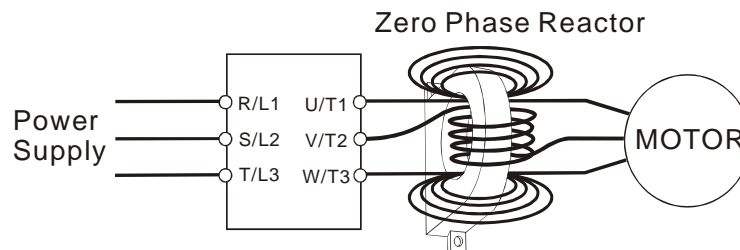

Figure B: Multi-turn zero phase reactor

Installation notes

Install the zero phase reactor at the output terminal of the frequency converter (U.V.W.). After the zero phase reactor is installed, it reduces the electromagnetic radiation and load stress emitted by the wiring of the frequency converter. The number of zero phase reactors required for the drive depends on the wiring length and the drive voltage.

The normal operating temperature of the zero phase reactor should be lower than 85°C (176°F). However, when the zero phase reactor is saturated, its temperature may exceed 85°C (176°F). In this case, increase the number of zero phase reactors to avoid saturation. The following are reasons that might cause saturation of the zero phase reactors: the drive wiring is too long, the drive has several sets of loads, the wiring is in parallel, or the drive uses high capacitance wiring. If the temperature of the zero phase reactor exceeds 85°C (176°F) during the operation of the drive, increase the number of zero phase reactors.

Recommended maximum wiring gauge when installing zero phase reactor

Model # of Zero Phase Reactor	Max. Wire Gauge or LUG Width	Max. Wire Gauge AWG (1C*3)		Max. Wire Gauge AWG (1C*4)	
		75°C	90°C	75°C	90°C
RF008X00A	13 mm	3 AWG	1 AWG	3 AWG	1 AWG
T600006L2040W453	11 mm	9 AWG	4 AWG	6 AWG	6 AWG
T600006L2050W565	16 mm	1 AWG	2/0 AWG	1 AWG	1/0 AWG

Zero Phase Reactor for Signal Cable

To solve interference problems between signal cables and electric devices, install a zero phase reactor on the signal cable. Install it on the signal cable which is the source of the interference to suppress the noise for a better signal. The model names and dimensions are listed in the table below.

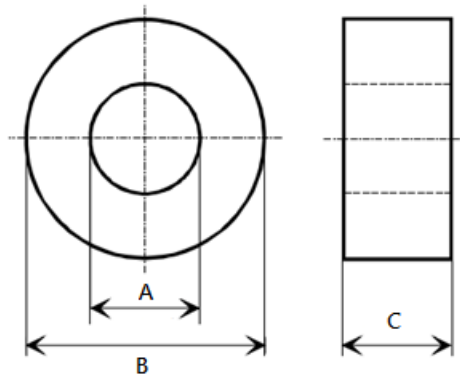

Model	A	B	C
T60004L2016W620	10.7	17.8	8.0
T60004L2025W622	17.5	27.3	12.3

Unit: mm

7-6 EMC Filter

To increase the EMC capability for environment and machinery, be compliant with the EMC regulations, and reduce problems caused by EMC, use an EMC filter. Refer to the following table to choose an optional EMC filter.

Frame	Model #	Input Current [A]	Filter model #	Recommended model of zero phase reactor		Conducted emission maximum motor cable length				Radiated emission maximum motor cable length				
						C1 30 m		C2 100 m	C2 100 m					
						Position to place zero phase reactor								
DELTA	V _{AC}	*1	*2	*3	N/A	*1	*2	*3						
A	VFD0A8ME11ANNAA VFD0A8ME11ANSAA	3.7	EMF11AM21A	RF008X00A	T60006L2040W453									
	VFD1A6ME11ANNAA VFD1A6ME11ANSAA	6.8							NA					
	VFD2A5ME11ANNAA VFD2A5ME11ANSAA	10.1												
	VFD0A8ME21ANNAA VFD0A8ME21ANSAA	3.2												
	VFD1A6ME21ANNAA VFD1A6ME21ANSAA	3.8					✓	✓	NA		✓	✓		
	VFD2A8ME21ANNAA VFD2A8ME21ANSAA	6.7					✓	✓	NA		✓	✓		
	VFD0A8ME23ANNAA VFD0A8ME23ANSAA	1.2	EMF10AM23A				✓	✓			✓	✓		
	VFD1A6ME23ANNAA VFD1A6ME23ANSAA	2.2					✓	✓	NA		✓	✓		
	VFD2A8ME23ANNAA VFD2A8ME23ANSAA	3.8					✓	✓	NA		✓	✓		
	VFD4A8ME23ANNAA VFD4A8ME23ANSAA	6					✓	✓	NA		✓	✓		
	VFD1A5ME43ANNAA VFD1A5ME43ANSAA	2.5	EMF6A0M43A					✓	NA			✓		
	VFD2A7ME43ANNAA VFD2A7ME43ANSAA	4.2						✓	NA			✓		
	B	VFD4A8ME21ANNAA VFD4A8ME21ANSAA	10.5			EMF11AM21A			✓	✓	NA		✓	✓
		VFD7A5ME23ANNAA VFD7A5ME23ANSAA	9.6			EMF10AM23A			✓	✓	NA		✓	✓
		VFD4A2ME43ANNAA VFD4A2ME43ANSAA	6.4			EMF6A0M43A				✓	NA			✓
	C	VFD4A8ME11ANNAA VFD4A8ME11ANSAA	20.6			EMF27AM21B	RF008X00A	T60006L2040W453				NA		
VFD11AME21ANNAA VFD11AME21ANSAA		26.3	EMF27AM21B						✓	NA			✓	
VFD7A5ME21ANNAA VFD7A5ME21ANSAA		17.9	EMF27AM21B							✓	NA		✓	
VFD11AME23ANNAA VFD11AME23ANSAA		15	EMF24AM23B		✓	✓			NA		✓	✓		
VFD17AME23ANNAA VFD17AME23ANSAA		23.4	EMF24AM23B		✓	✓			NA		✓	✓		
VFD5A5ME43ANNAA VFD5A5ME43ANSAA		7.2	EMF12AM43B							NA				
VFD9A0ME43ANNAA VFD9A0ME43ANSAA		11.6	EMF12AM43B			✓			✓	NA		✓	✓	
D		VFD25AME23ANNAA VFD25AME23ANSAA	32.4	EMF33AM23B	RF008X00A	T60006L2050W565			✓	✓		NA	✓	✓
	VFD13AME43ANNAA VFD13AME43ANSAA	17.3	EMF23AM43B	✓			✓	✓	NA	✓	✓	✓		
	VFD17AME43ANNAA VFD17AME43ANSAA	22.6	EMF23AM43B	✓			✓	✓	NA	✓	✓	✓		

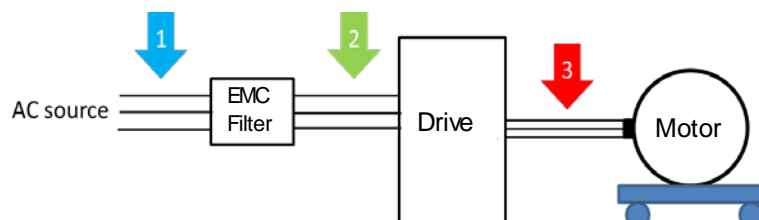

Filter Dimension

Frame A filter

EMF11AM21A

EMF10AM23A

EMF6A0M43A

Screw	Torque
M5 * 2	16–18 kg-cm / [13.9–17.3 lb-in.] / [1.56–1.96 Nm]
M4 * 2	14–16 kg-cm / [12.2–13.8 lb-in.] / [1.38–1.56 Nm]

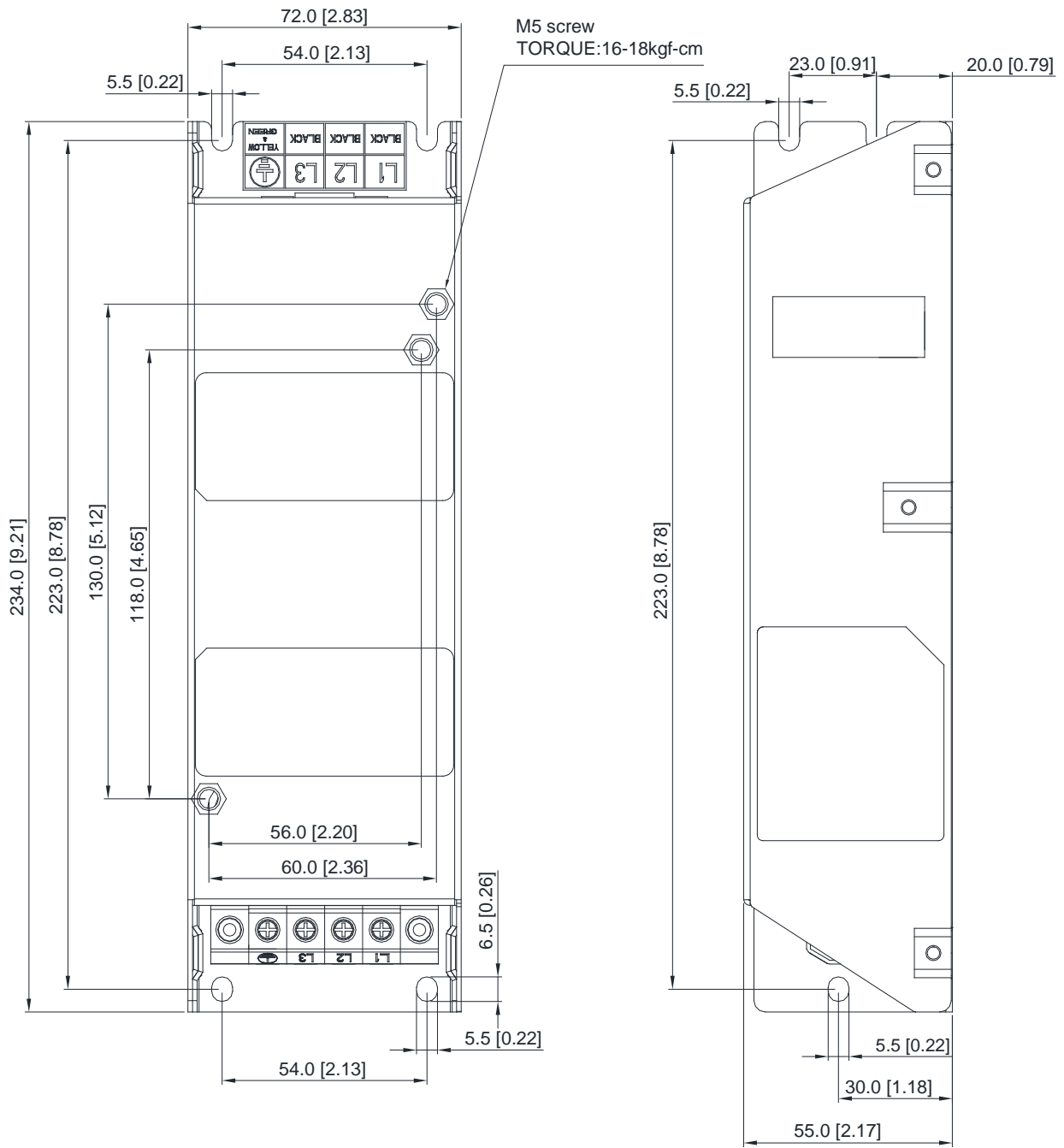

Unit: mm [inch]

Frame B filter

- EMF27AM21B; EMF24AM23B
- EMF33AM23B; EMF12AM43B
- EMF23AM43B

Screw	Torque
M5 * 4	16–18 kg-cm / [13.9–17.3 lb-in.] / [1.56–1.96 Nm]

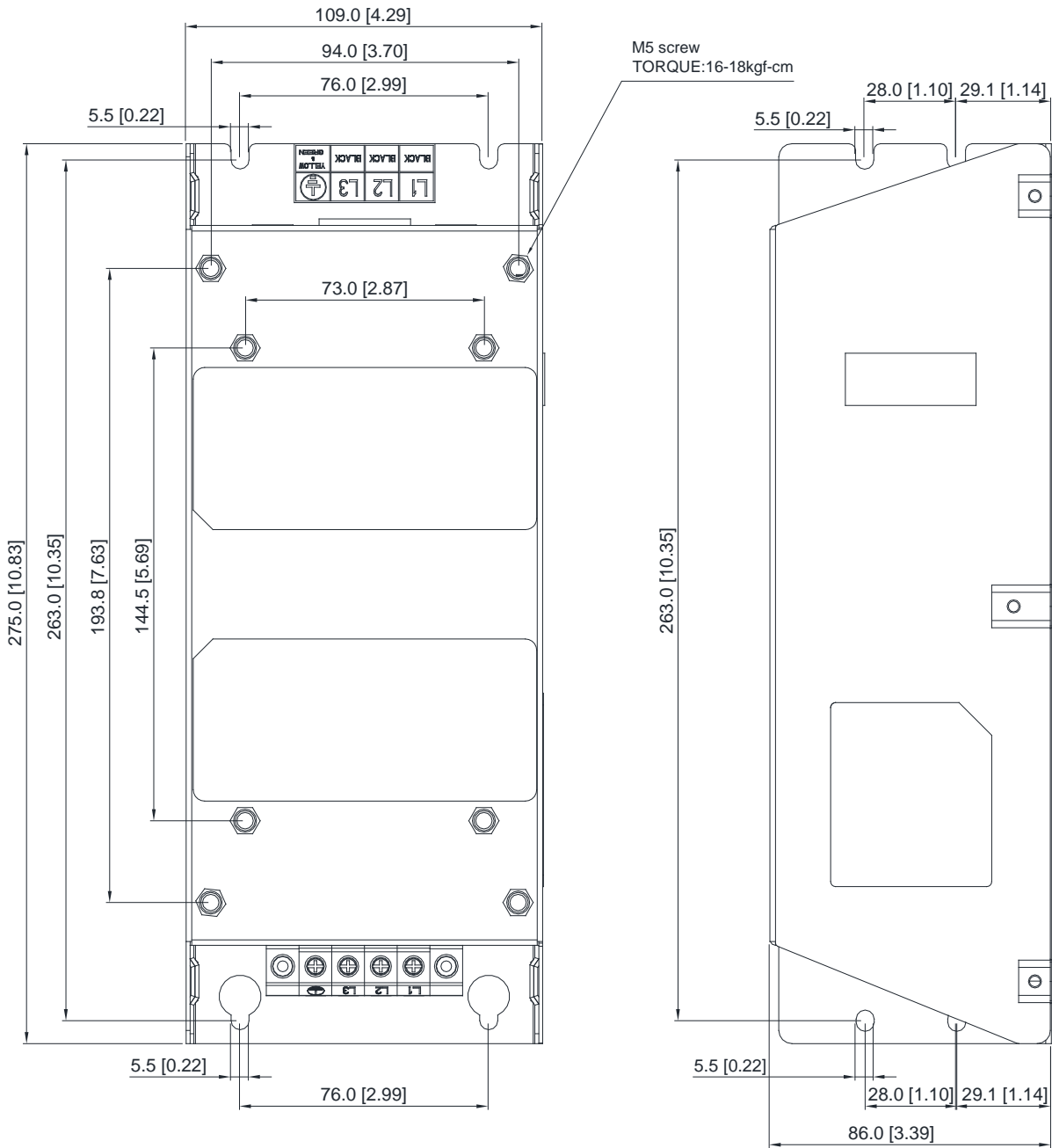

Unit: mm [inch]

7-7 EMC Shield Plate

EMC Shield Plate (for use with shielded cable)

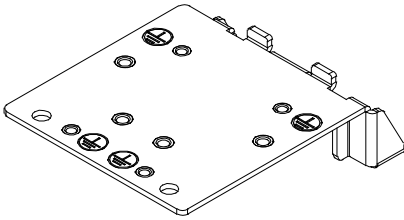
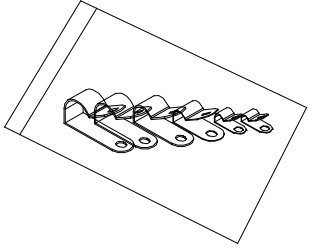
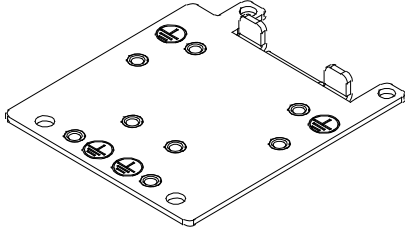
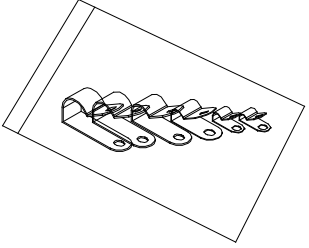
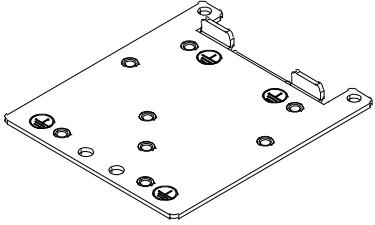
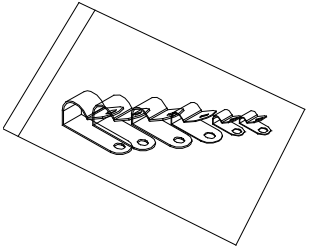
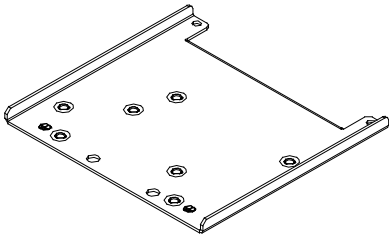
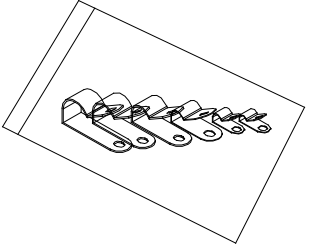
Frame	Model of EMC Shield Plate	Reference figure	
A	MKM-EPA		
B	MKM-EPB		
C	MKM-EPC		
D	MKM-EPD		

Installation

(Frame A model as an example)

- As shown on the right figures, fix the iron plate on the AC motor drive.

Torque value:

Frame	Screw	Torque
A	M3.5	6–8 kg-cm / [5.2–6.9 lb-in.] / [0.59–0.78 Nm]
B	M4	6–8 kg-cm / [5.2–6.9 lb-in.] / [0.59–0.78 Nm]
C	M4	6–8 kg-cm / [5.2–6.9 lb-in.] / [0.59–0.78 Nm]
D	M3	4–6 kg-cm / [3.5–5.2 lb-in.] / [0.39–0.59 Nm]

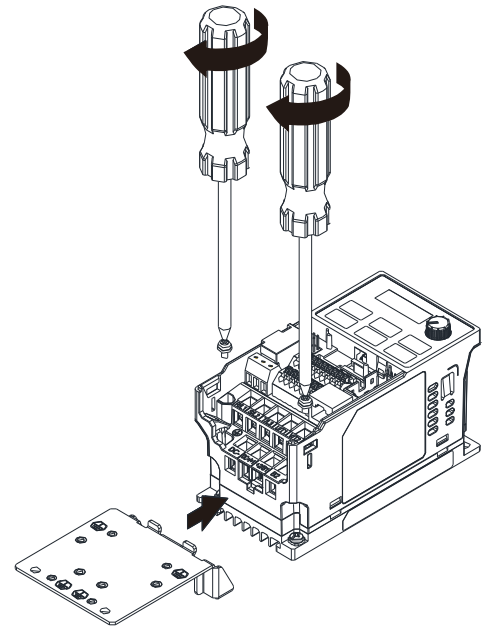

- After selecting a suitable R-clip according to the wire gauge used, fix the R-clip on the shield plate.

Screw	Torque
M4	6–8 kg-cm / [5.2–6.9 lb-in.] / [0.59–0.78 Nm]

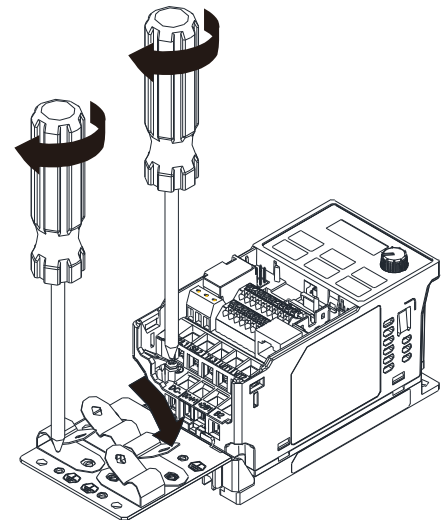

Dimensions of EMC Shield Plate

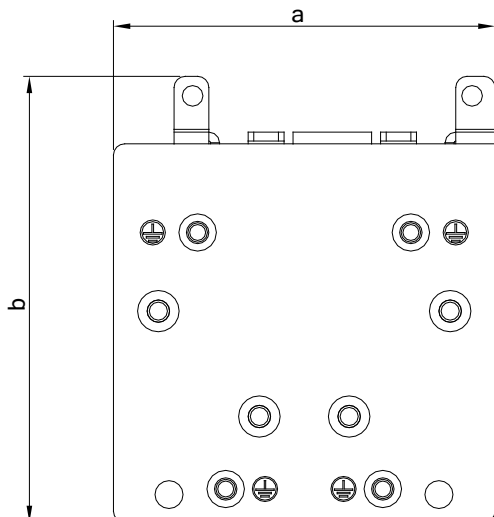

Model	Dimensions of Shield Plate mm [inch]	
	a	b
MKM-EPA	69.3 [2.73]	80.0 [3.15]
MKM-EPB	67.7 [2.67]	79.7 [3.14]
MKM-EPC	78.0 [3.07]	91.0 [3.58]
MKM-EPD	103.4 [4.07]	97.0 [3.82]

Recommended wire mounting method

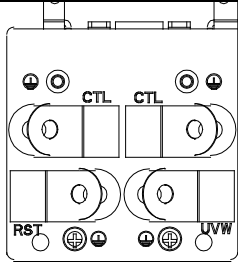
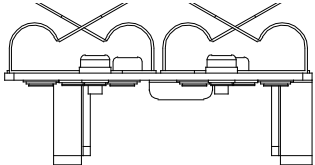
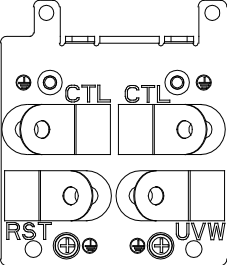
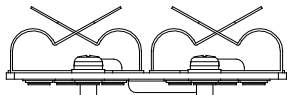
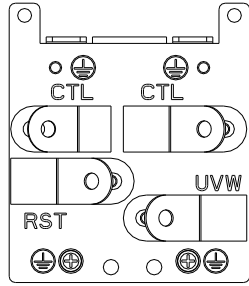
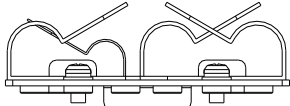
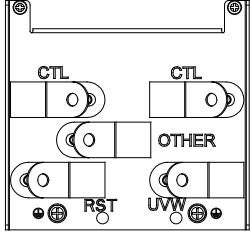
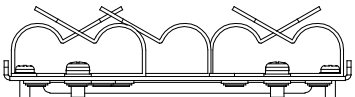
Frame	Model of EMC Shield Plate	Reference figure	
A	MKM-EPA		
B	MKM-EPB		
C	MKM-EPC		
D	MKM-EPD		

7-8 Capacitive Filter

Installation diagram:

The capacitive filter (CXY101-43A) is a simple filter that supports basic filtering and noise interference reduction.

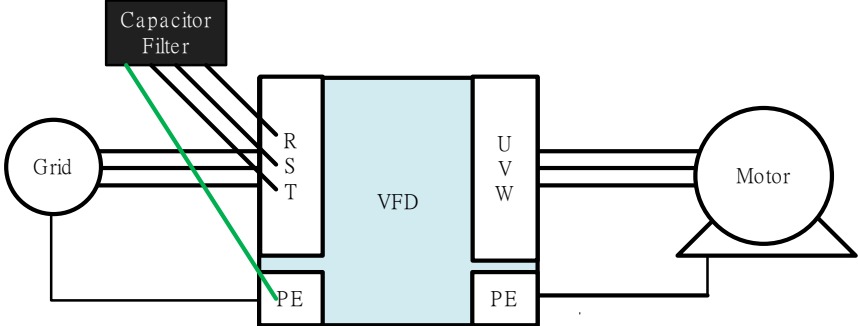

Capacitive filter and drive wiring figure:

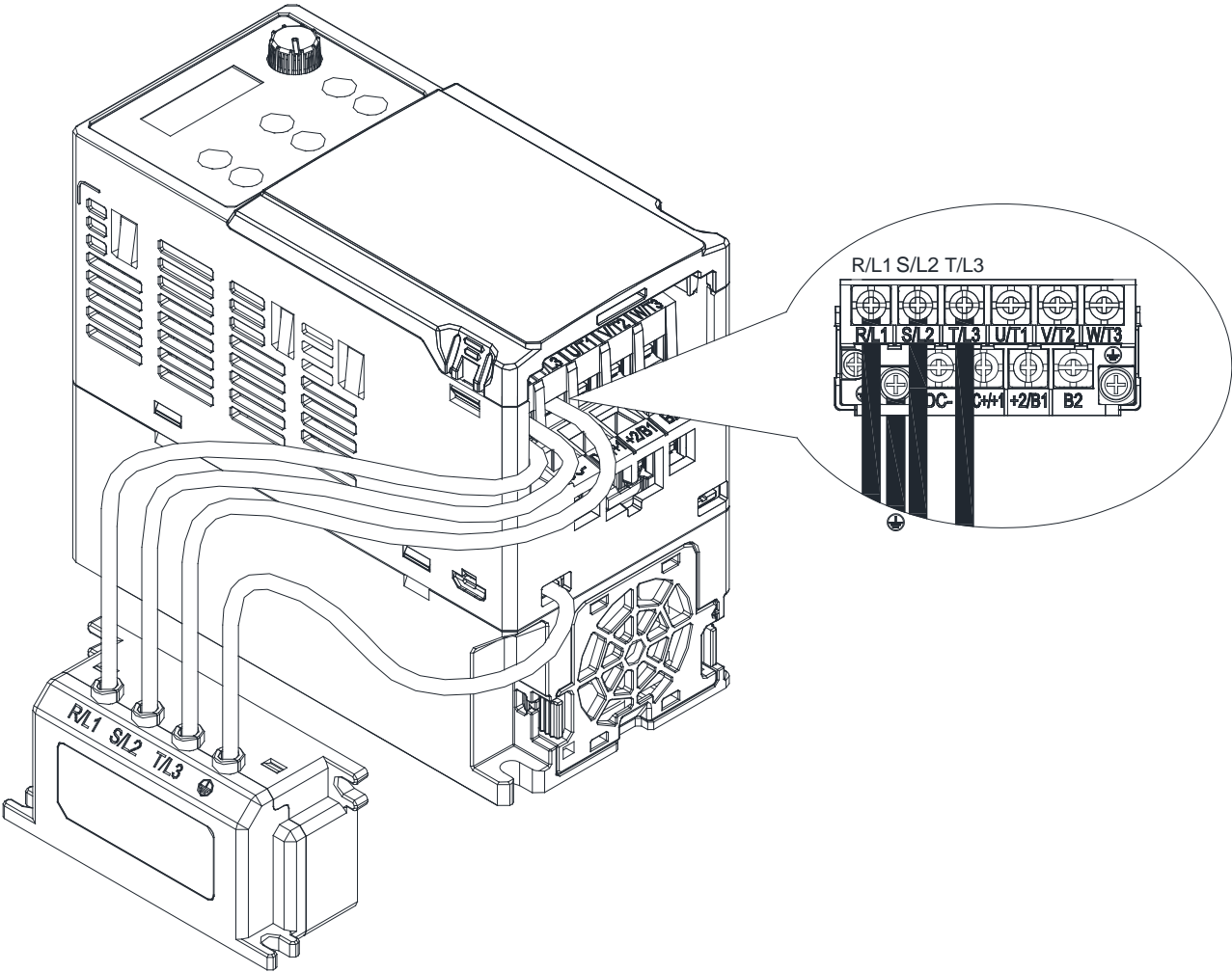

Specifications:

Model	Capacitance	Temperature range
CXY101-43A	Cx: 1 μ F \pm 20 % Cy: 0.1 μ F \pm 20 %	-40— +85°C

Dimensions:

CXY101-43A

Unit: mm [inch]

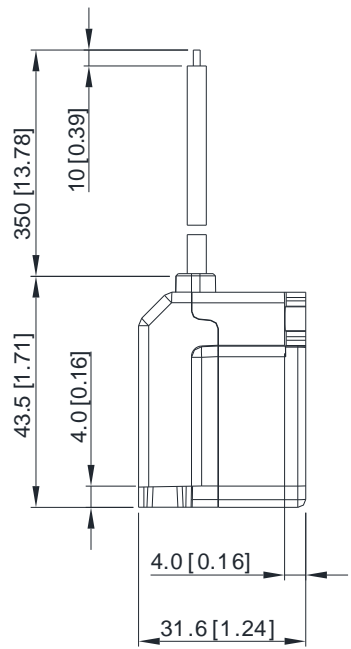
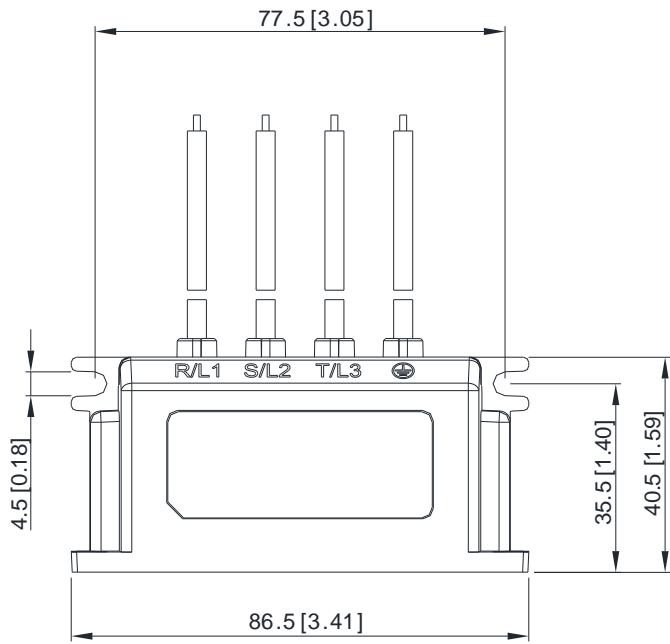
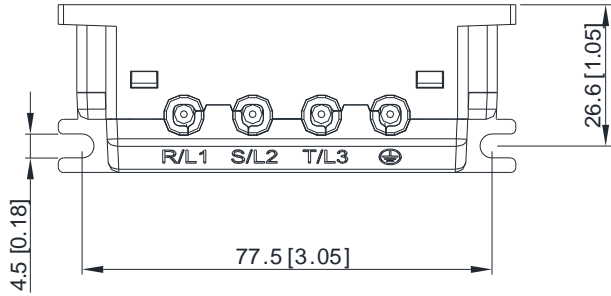

7-9 Conduit Box

Conduit boxes are in compliance with protection level NEMA 1 / UL Type 1.

Frame A (A1, A2)

Conduit box model: MKME-CBA0

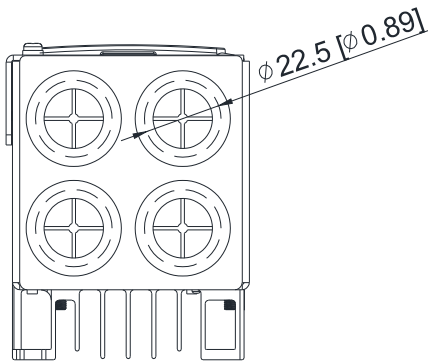
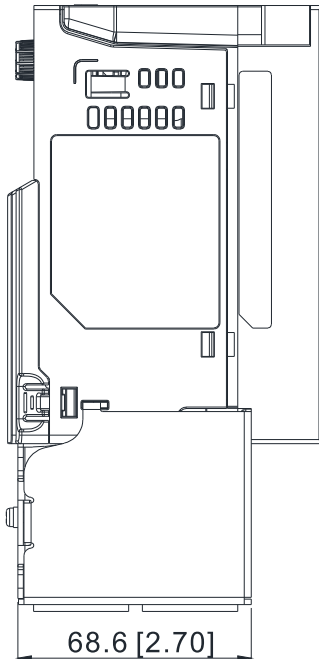
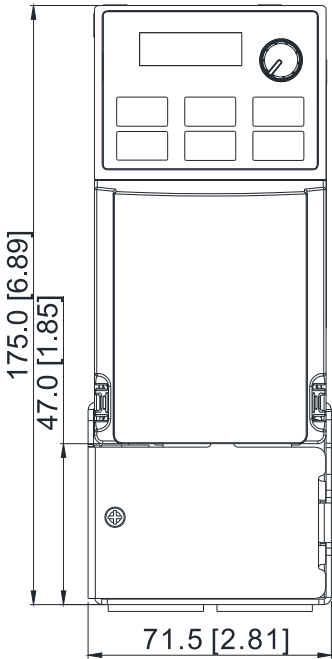

Unit: mm [inch]

Frame A (A3–A6)

Conduit box model: MKME-CBA

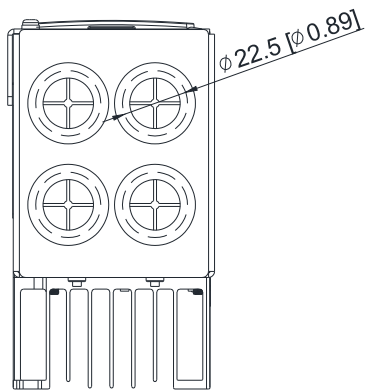
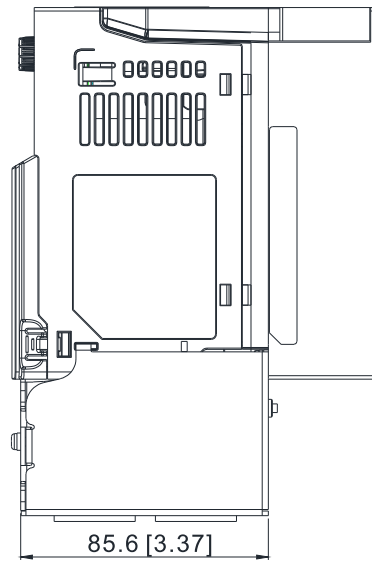
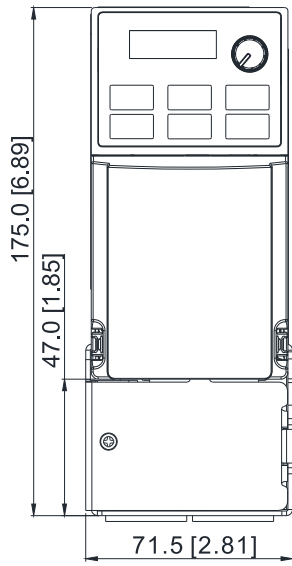

Unit: mm [inch]

Frame B

Conduit box model: MKME-CBB

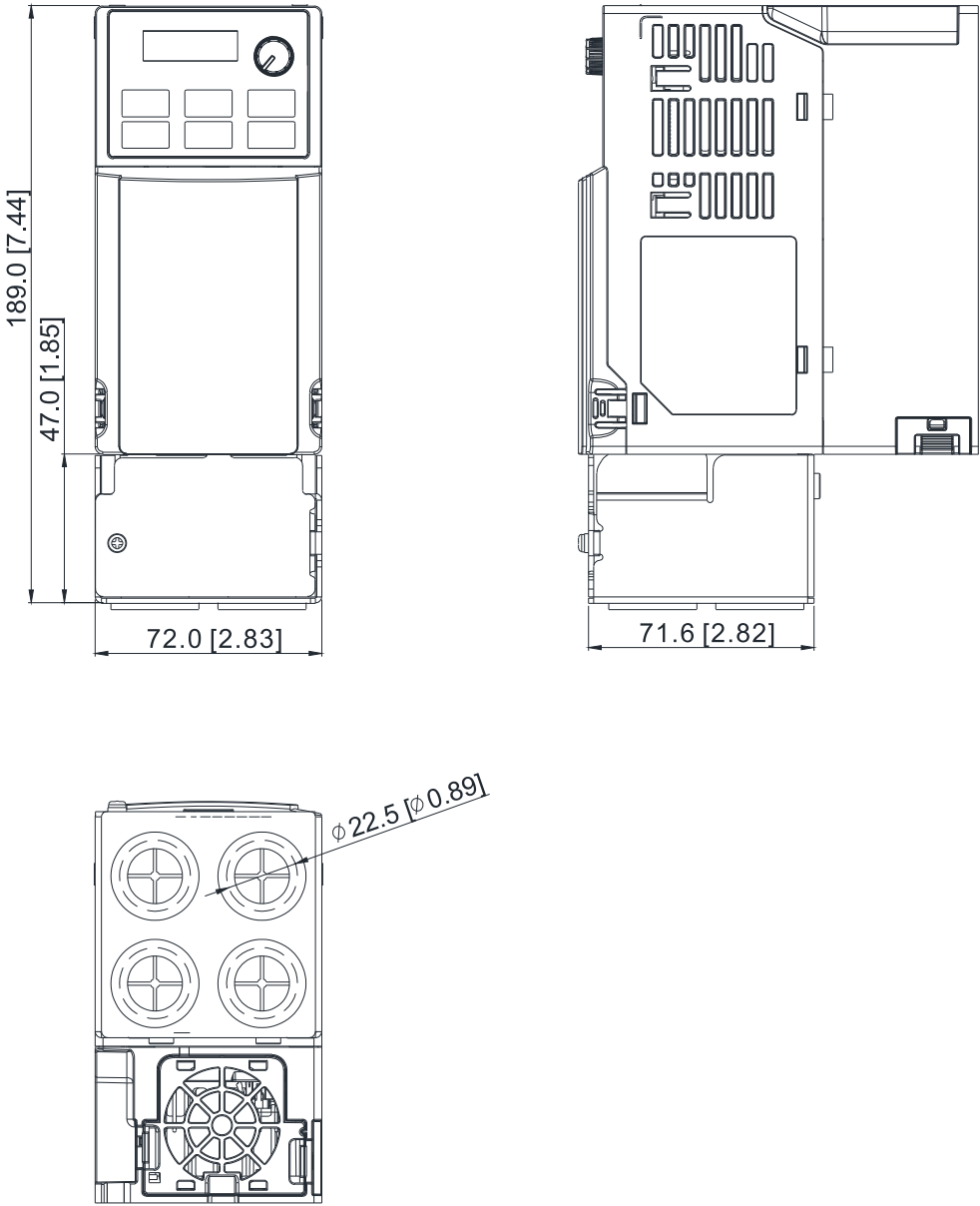

Unit: mm [inch]

Frame C

Conduit box model: MKME-CBC

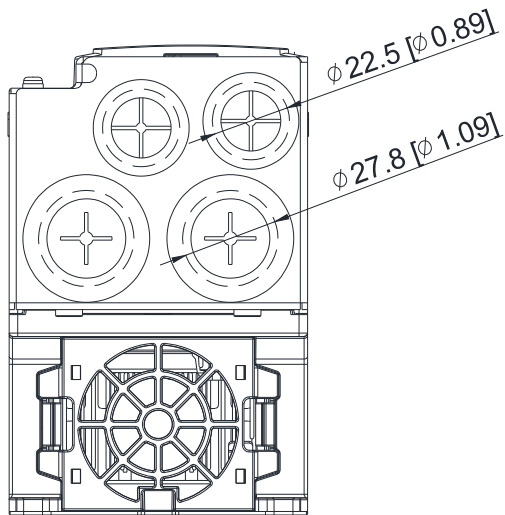
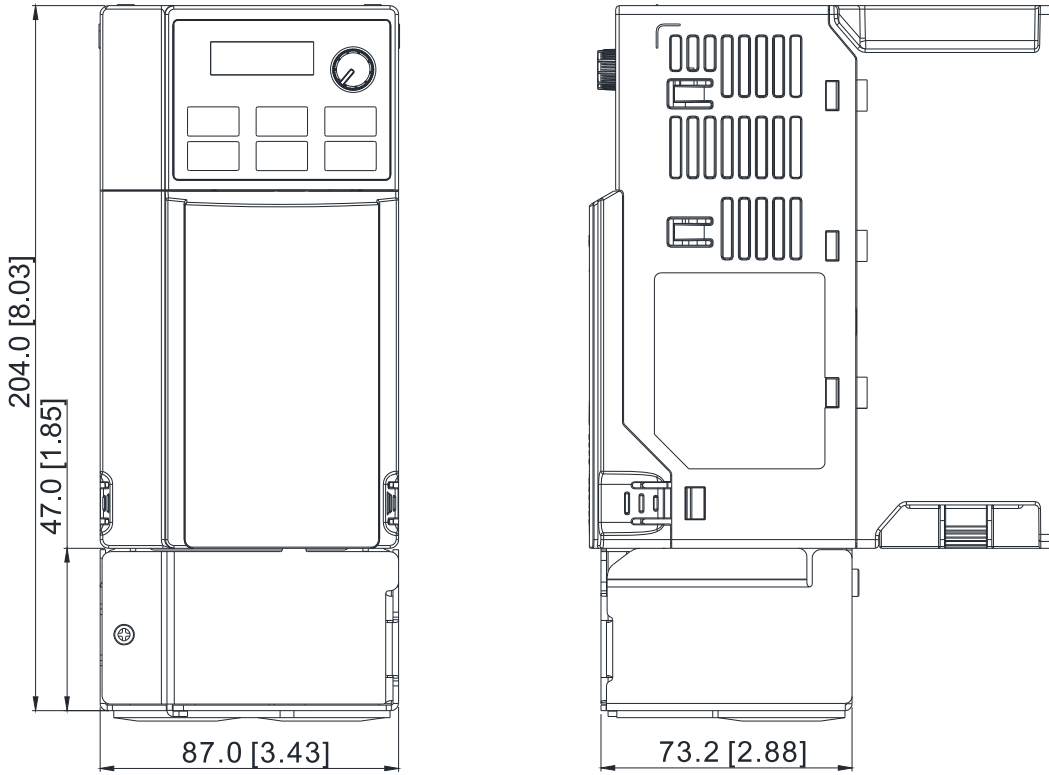

Unit: mm [inch]

Frame D

Conduit box model: MKME-CBD

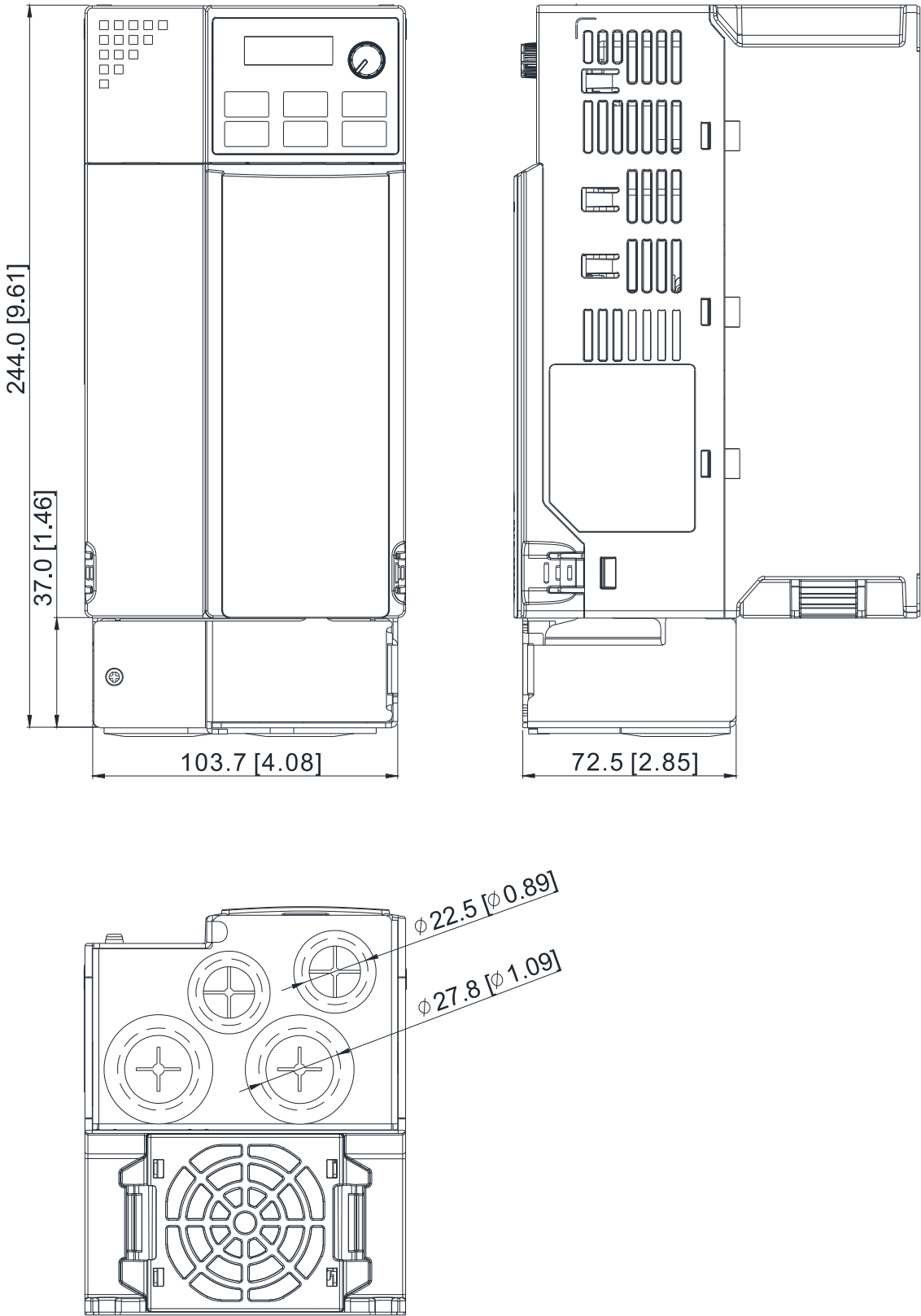

Unit: mm [inch]

Installation:

Recommended screw torque: M3: 4–6 kg-cm / [3.5–5.2 lb-in.] / [0.39–0.59 Nm]

M3.5: 4–6 kg-cm / [3.5–5.2 lb-in.] / [0.39–0.59 Nm]

M4: 6–8 kg-cm / [5.2–6.9 lb-in.] / [0.59–0.78 Nm]

Frame A

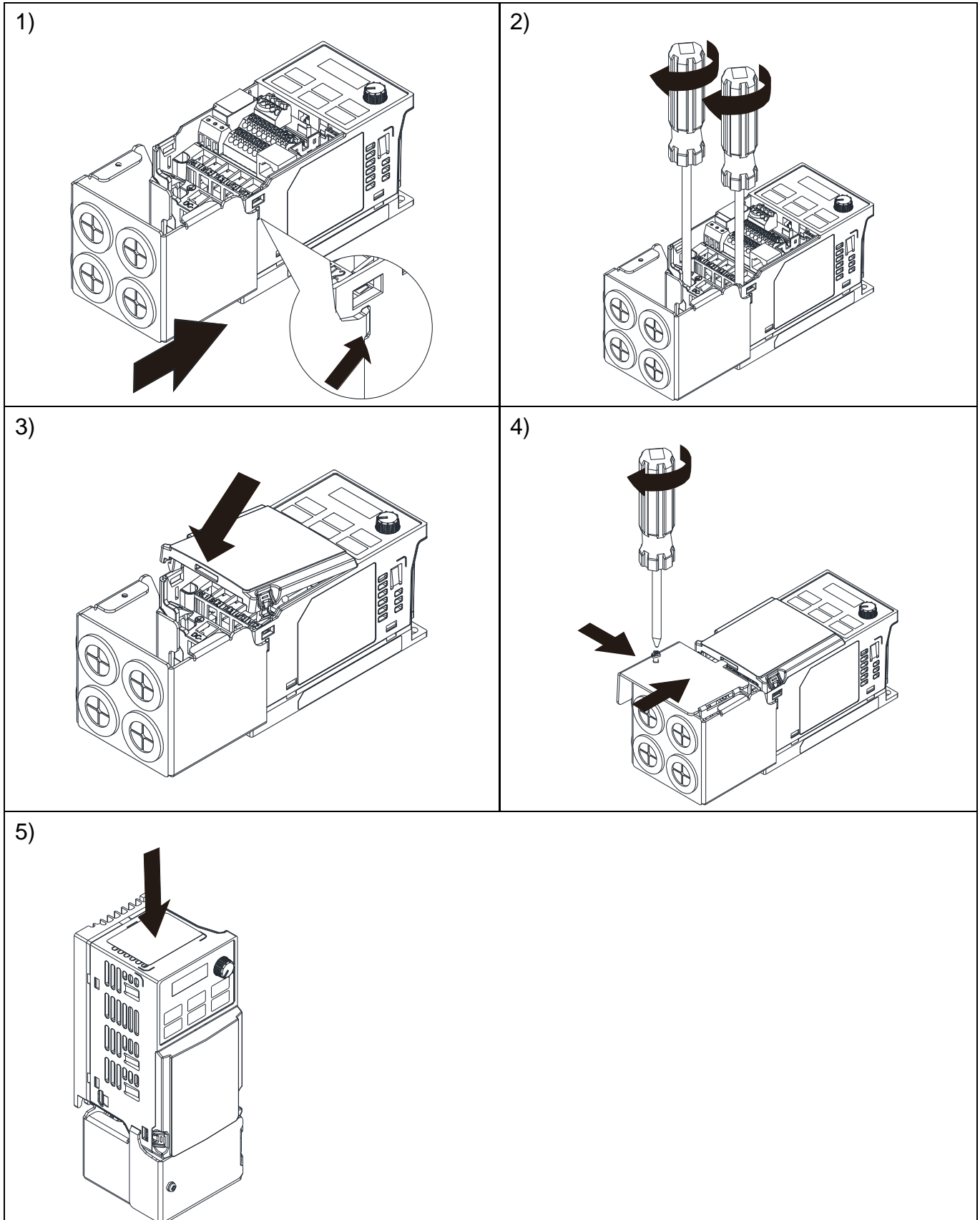

Frame B-D

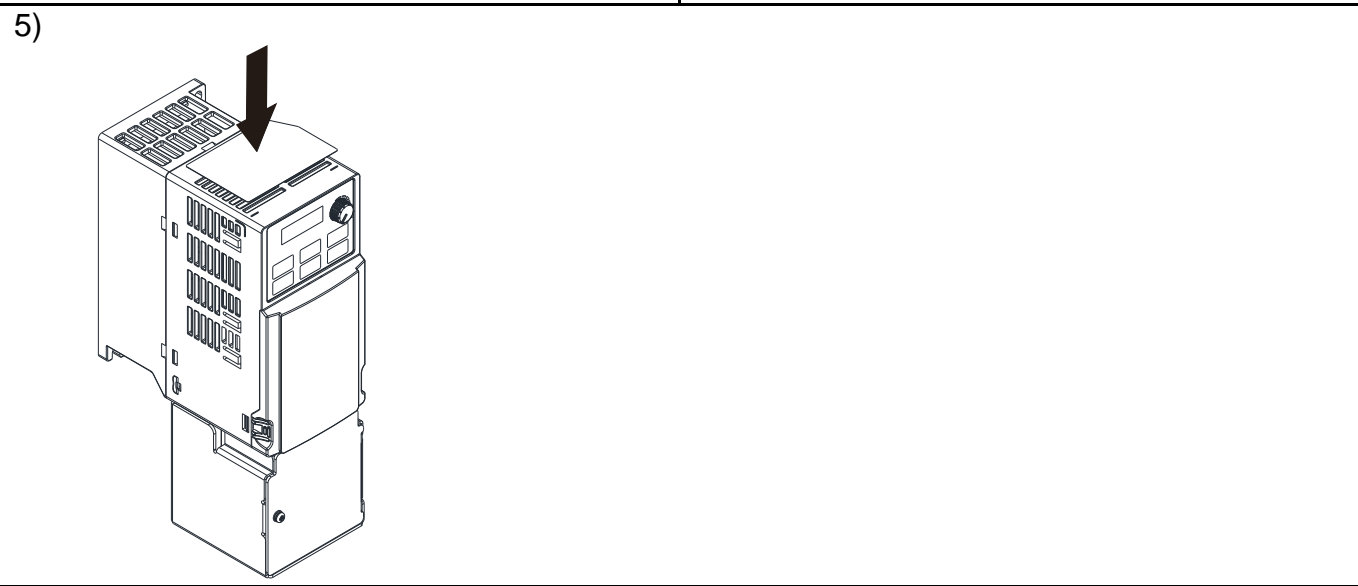
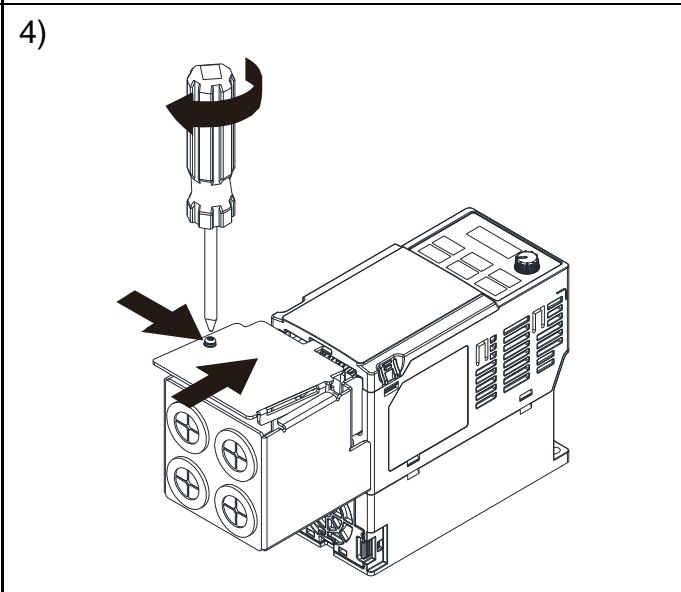
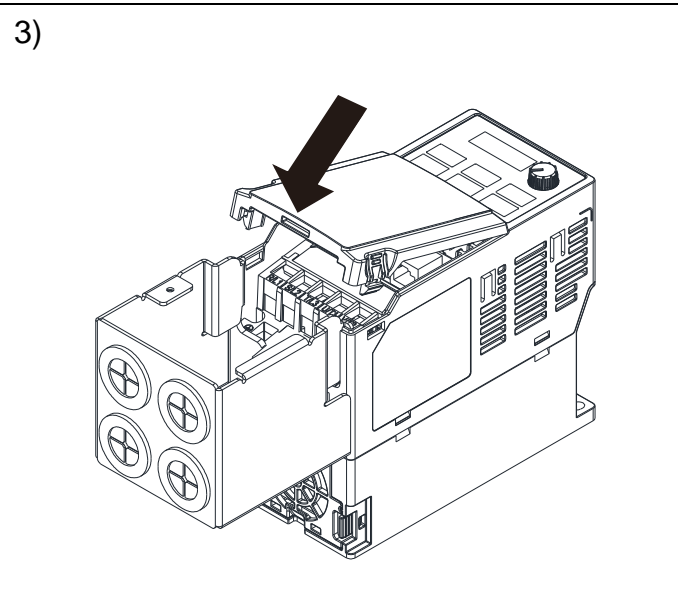
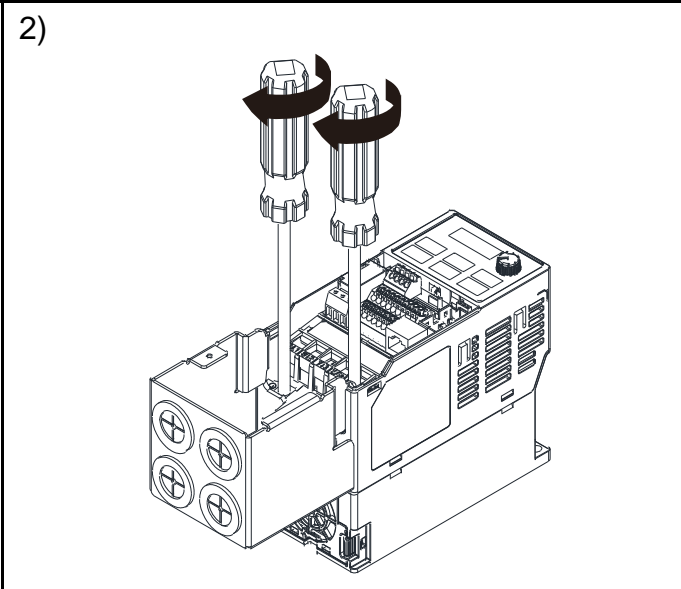
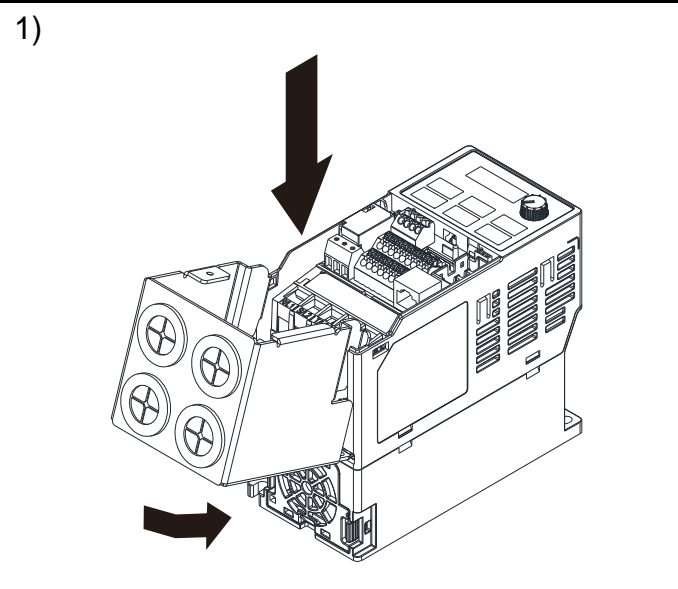

7-10 Fan Kit

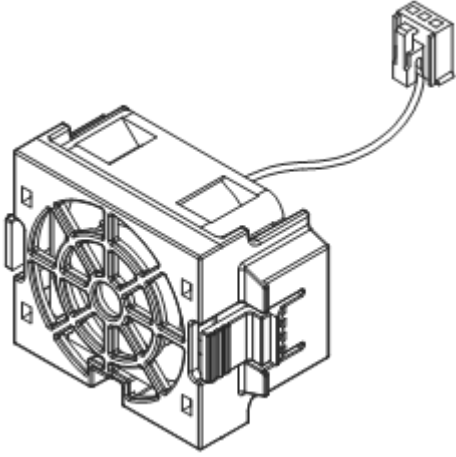
Frame	Fan Model	Fan Kit
A	MKM-FKMA	
B	MKM-FKMB	
C	MKM-FKMC	
D	MKM-FKMD	

Fan Removal

1. As shown in the figure, press the tabs on both sides of the fan to remove it.

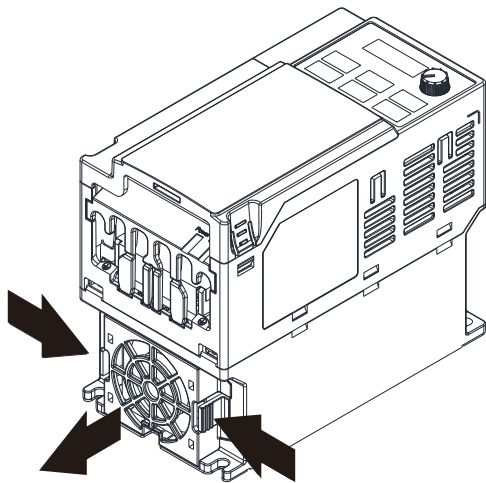

2. Disconnect the power cable when removing the fan.

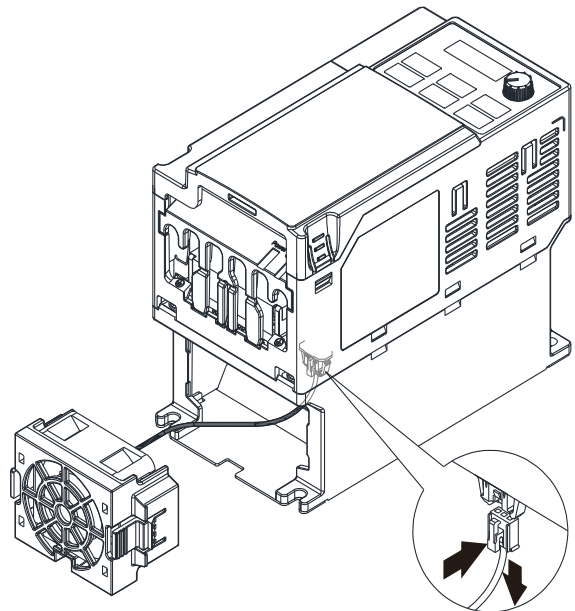

7-11 DIN-Rail Mounting

MKM-DRB (applicable for Frame A and Frame B)

Screw	Torque
M*2PCS	8–10 kg-cm [6.9–8.7 lb-in.] [0.7–98 Nm]

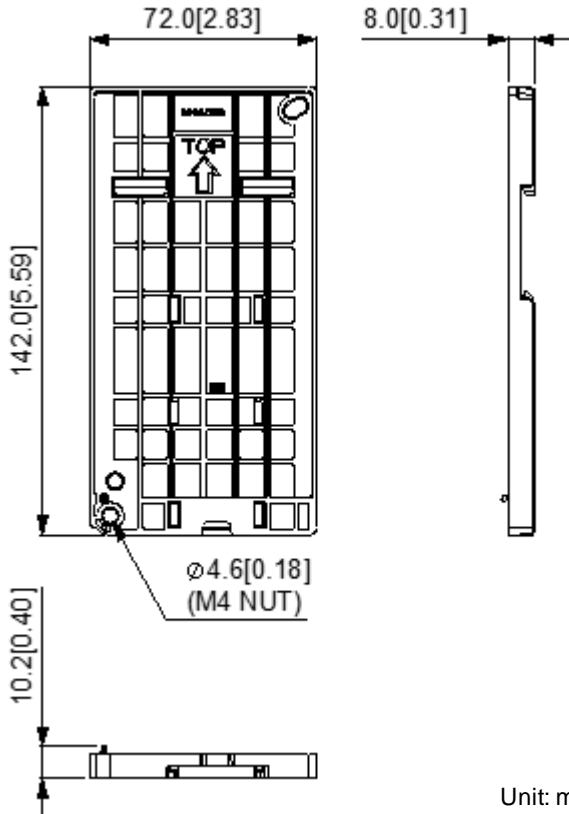

Unit: mm [inch]

MKM-DRC (applicable for Frame C)

Screw	Torque
M5*4PCS	10–12 kg-cm [8.7–10.4 lb-in.] [0.98–1.18 Nm]

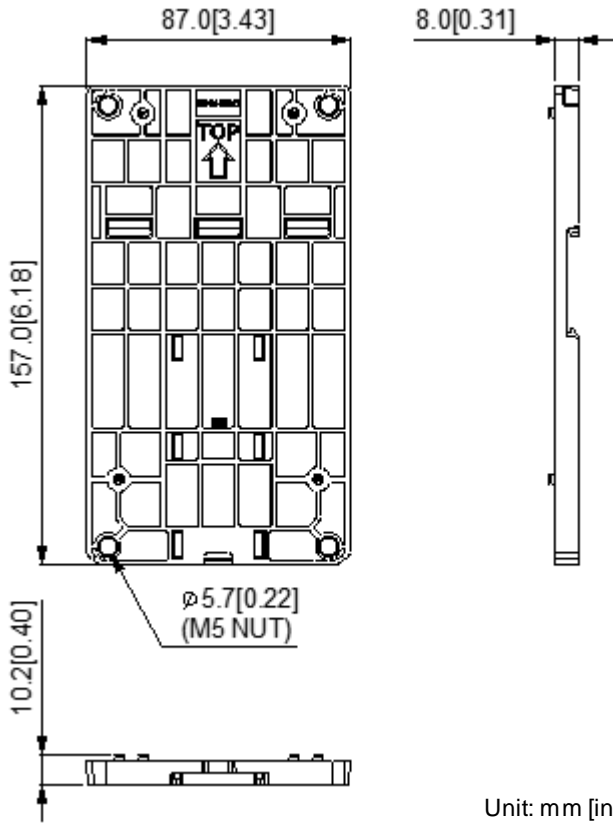

Unit: mm [inch]

Installation

	Screw	Torque
MKM-DRB	M4*P0.7*2PCS	8~10 kg-cm [6.9~8.7 lb-in.] [0.78~0.98 Nm]
MKM-DRC	M5*P0.8*4PCS	10~12 kg-cm [8.7~10.4 lb-in.] [0.98~1.18 Nm]

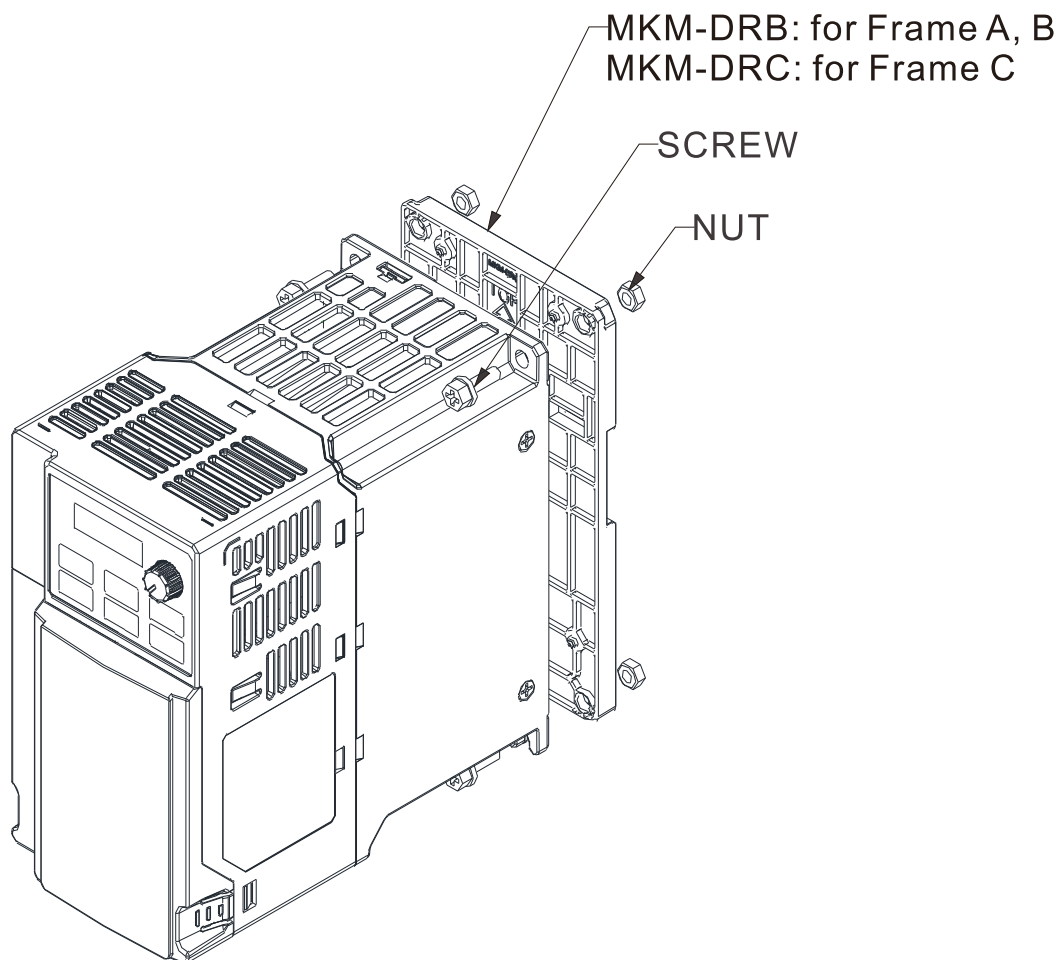

7-12 Mounting Adapter Plate

This mounting adapter accessory is to change the wiring method for the ME300/MS300/MH300 series to provide flexible installation. It changes the wiring from the main input/motor output at the bottom to the main input from the top and the motor output from the bottom. However, when you use the mounting adapter plate to change the drive from the VFD-E/VFD-EL series to the ME300/MS300/MH300 series, you can still use the original wiring method. The following table shows the correspondences.

Series Models	ME/MS/MH300	VFD-E	VFD-EL
MKM-MAPB	Frame A-B	Frame A	Frame A
MKM-MAPC	Frame C	Frame B	Frame B

MKM-MAPB:

Applicable for Frame A and B

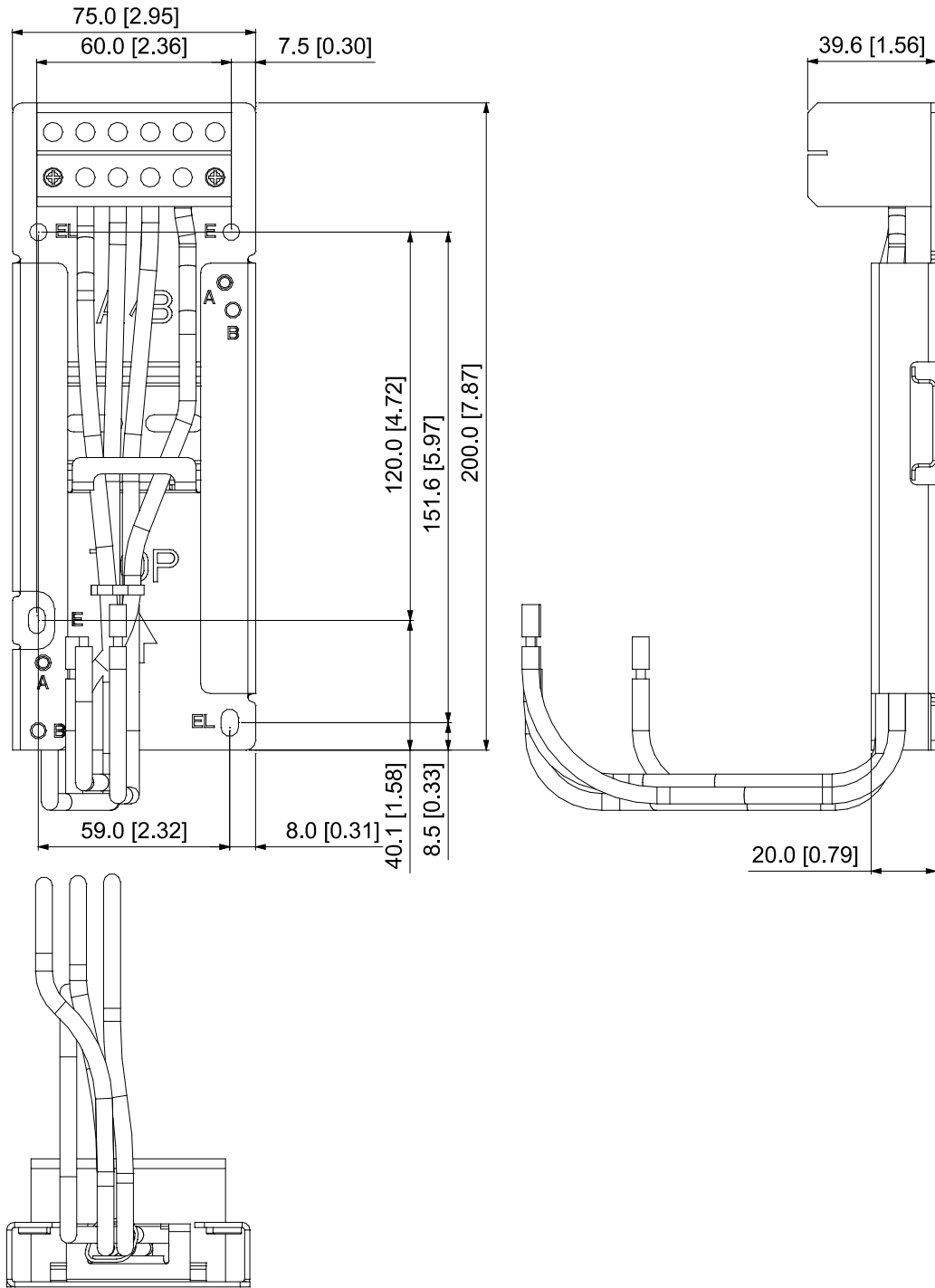

Unit: mm [inch]

MKM-MAPC:
Applicable for Frame C

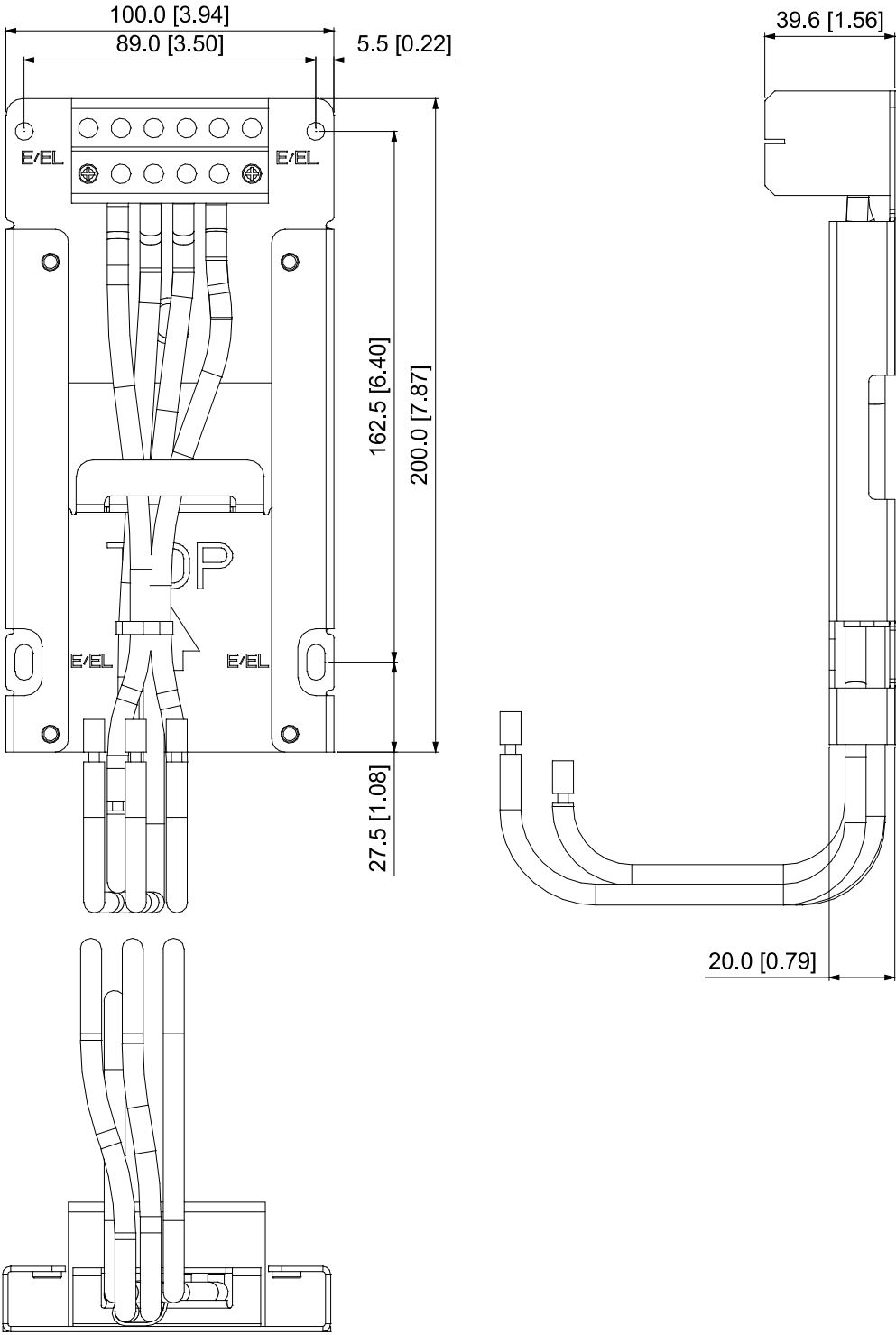

Unit: mm [inch]

Installation

Frame A and B

Screw	Torque
M4	14–16 kg-cm / [12.4–13.9 lb-in.] / [1.37–1.57 Nm]
M5	16–20 kg-cm / [13.9–17.4 lb-in.] / [1.57–1.96 Nm]

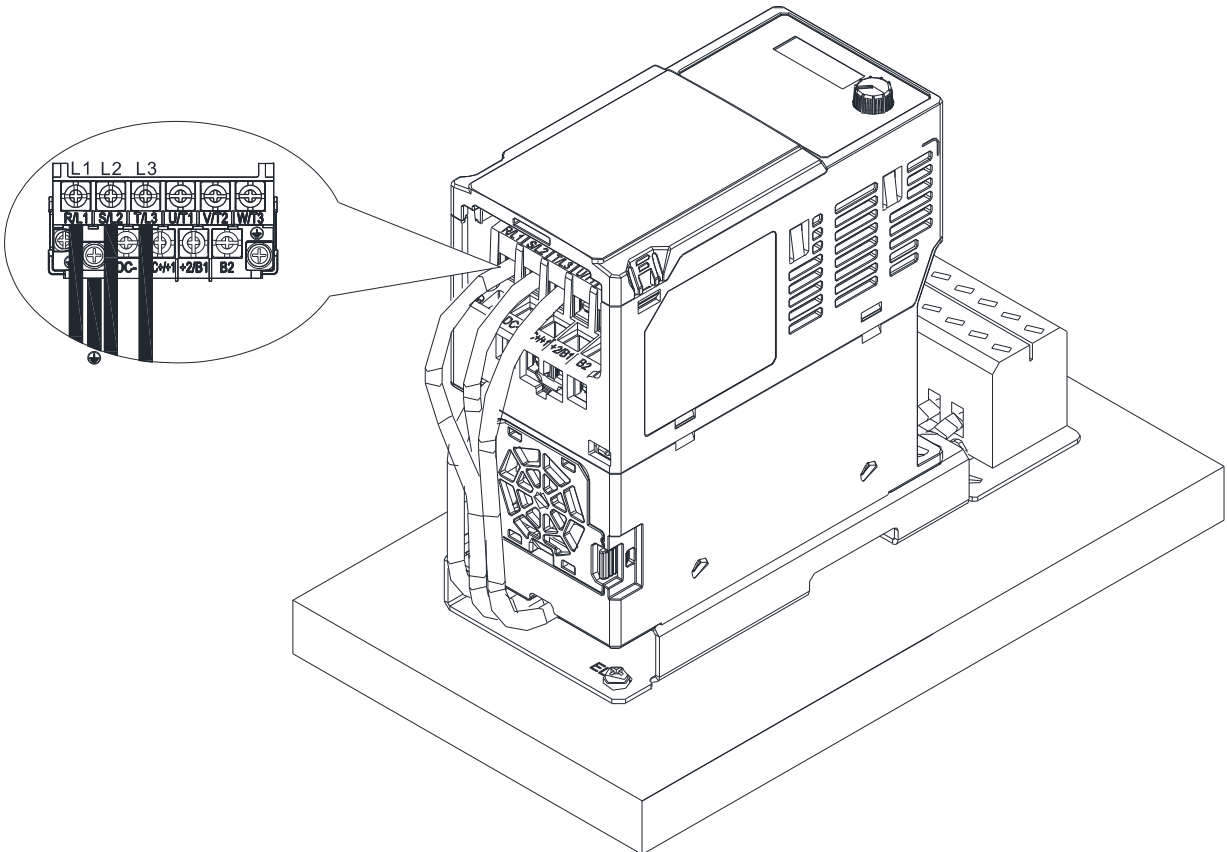
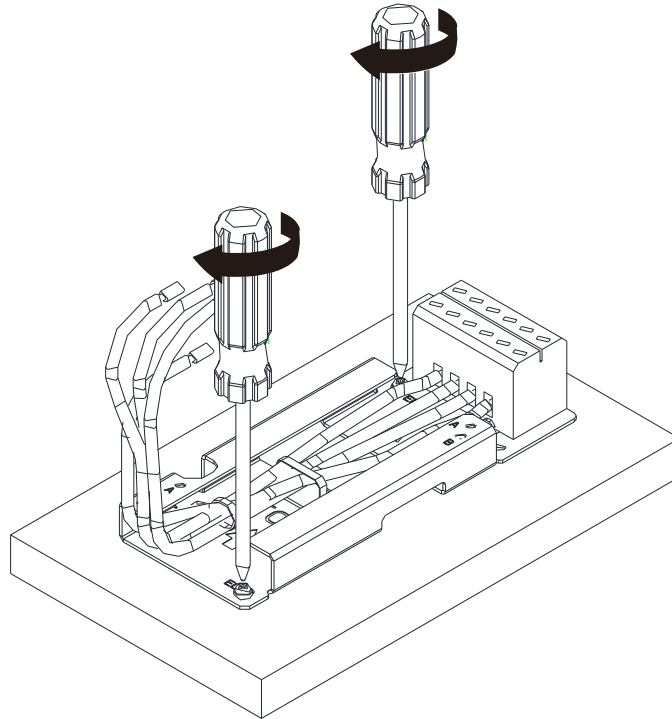

Unit: mm [inch]

Frame C

Screw	Torque
M4	14–16 kg-cm / [12.4–13.9 lb-in.] / [1.37–1.57 Nm]
M5	16–20 kg-cm / [13.9–17.4 lb-in.] / [1.57–1.96 Nm]

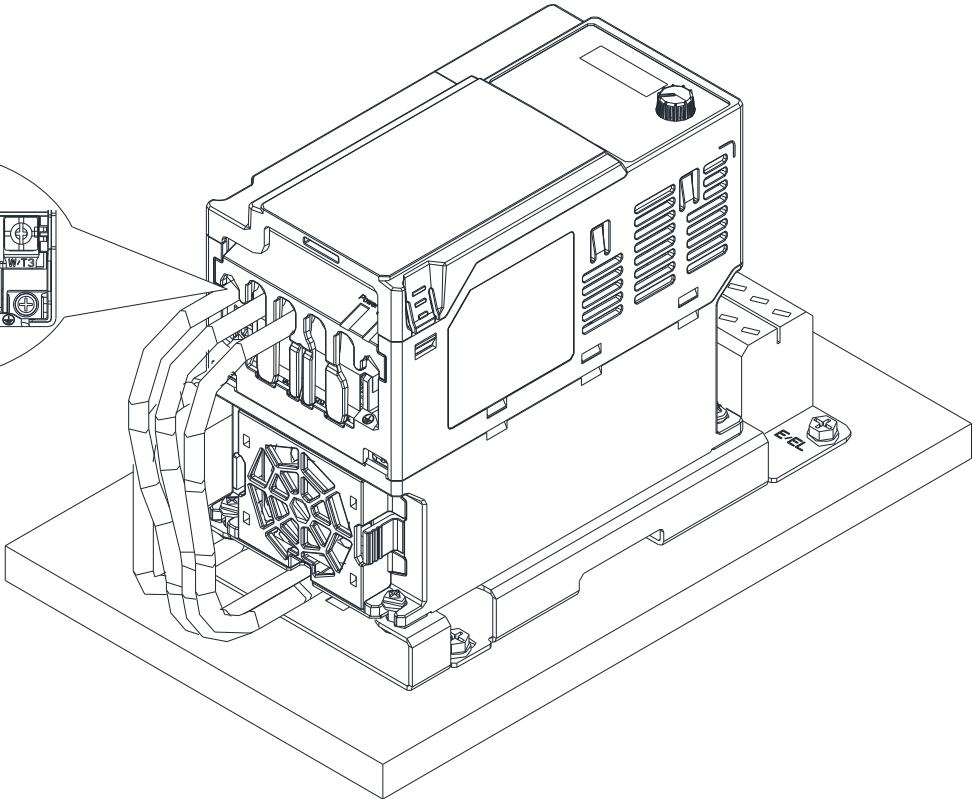
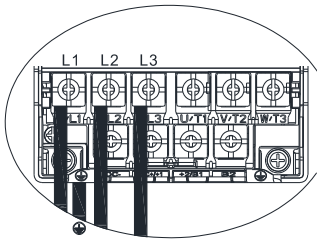
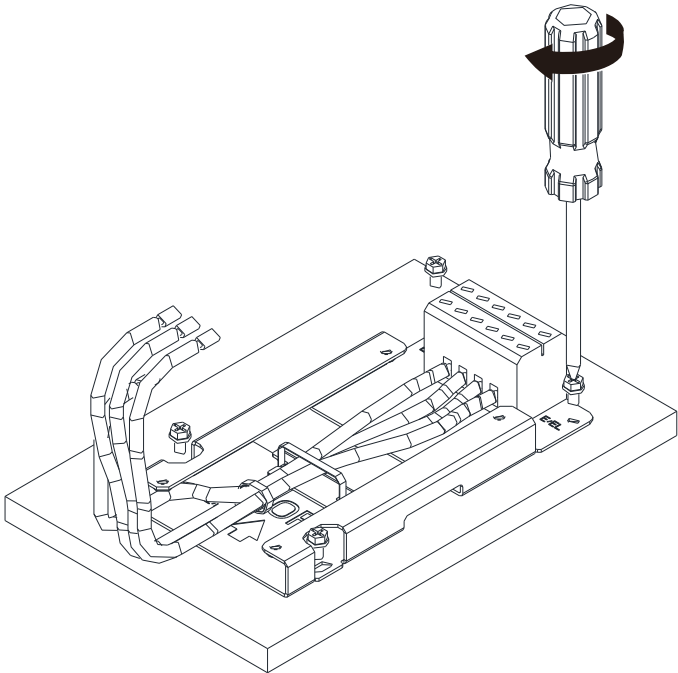

Unit: mm [inch]

7-13 Digital Keypad–KPC-CC01, KPC-CE01

7-13-1 Keypad Panel introduction

The default communication protocol for ME300 is ASCII 9600, 7, N, 2, whereas the default communication protocol for KPC-CC01 is RTU 19200, 8, N, 2. So you must set the ME300 communication parameters as follows to connect it to KPC-CC01.

- Pr.09-00 Communication Address: Settings = 1
- Pr.09-01 COM1 Transmission Speed (Baud rate): Settings = 19.2 Kbps
- Pr.09-04 COM1 Communication Protocol: Settings = 13: 8N2 (RTU)

KPC-CC01

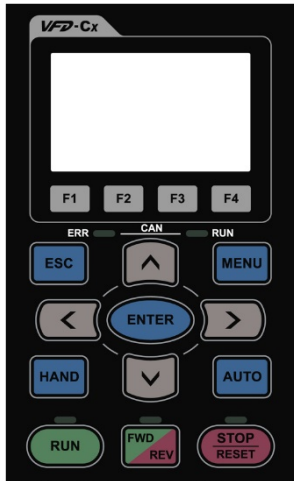

KPC-CE01













Communication Interface
RJ45 (socket), RS-485 interface

Installation Method



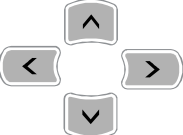

- Installed from external. The front cover is waterproof.
- Buy a MKC-KPPK model to do wall mounting or embedded mounting. Its protection level is IP66.
- The maximum RJ45 extension lead is 5 m (16 ft)
- This keypad can only be used on Delta's motor drive C2000, CH2000, CP2000, MS300, MH300, and ME300.

Descriptions of Keypad Functions

Key	Descriptions
	<p>Start Operation Key</p> <ol style="list-style-type: none"> 1. It is only valid when the source of operation command is from the keypad. 2. It can operate the AC motor drive by the function setting and the RUN LED will be ON. 3. It can be pressed repeatedly at stop process.
	<p>Stop Command Key. This key has the highest processing priority in any situation.</p> <ol style="list-style-type: none"> 1. When it receives STOP command, regardless of whether the AC motor drive is in operation or stop status, the AC motor drive executes the "STOP" command. 2. The RESET key can be used to reset the drive after a fault occurs. 3. If you cannot reset after the error: <ol style="list-style-type: none"> a. The condition which triggers the fault is not cleared. After you clear the condition, you can then reset the fault. b. The drive is in fault status when powered on. After you clear the condition, restart and then you can reset the fault.
	<p>Operation Direction Key</p> <ol style="list-style-type: none"> 1. This key only controls the operation direction, NOT the drive activation. FWD: forward, REV: reverse. 2. Refer to "Descriptions of LED Functions" for more details.
	<p>ENTER Key</p> <p>Press ENTER to go to the next menu level. If you are at the last level, press ENTER to execute the command.</p>
	<p>ESC Key</p> <p>ESC key function is to leave the current menu and return to the previous menu. It also functions as a return key or cancel key in a sub-menu.</p>

Key	Descriptions																		
	<p>Returns to the main menu. Menu content: KPC-CE01 only supports function 1, 5, 9 and 10.</p> <table border="0"> <tr> <td>1. Parameter Setup</td> <td>7. Language Setup</td> <td>13. Start-up Menu</td> </tr> <tr> <td>2. Quick Start</td> <td>8. Time Setup</td> <td>14. Main Page</td> </tr> <tr> <td>3. Application Selection List</td> <td>9. Keypad Locked</td> <td>15. PC Link</td> </tr> <tr> <td>4. Changed List</td> <td>10. PLC Function</td> <td>16. Start Wizard</td> </tr> <tr> <td>5. Copy Parameter</td> <td>11. Copy PLC</td> <td></td> </tr> <tr> <td>6. Fault Record</td> <td>12. Display Setup</td> <td></td> </tr> </table> <p>ME300 models do not support function 2, 8, 10, 11 and 16.</p>	1. Parameter Setup	7. Language Setup	13. Start-up Menu	2. Quick Start	8. Time Setup	14. Main Page	3. Application Selection List	9. Keypad Locked	15. PC Link	4. Changed List	10. PLC Function	16. Start Wizard	5. Copy Parameter	11. Copy PLC		6. Fault Record	12. Display Setup	
1. Parameter Setup	7. Language Setup	13. Start-up Menu																	
2. Quick Start	8. Time Setup	14. Main Page																	
3. Application Selection List	9. Keypad Locked	15. PC Link																	
4. Changed List	10. PLC Function	16. Start Wizard																	
5. Copy Parameter	11. Copy PLC																		
6. Fault Record	12. Display Setup																		
	<p>Direction: Left / Right / Up / Down</p> <ol style="list-style-type: none"> In the numeric value setting mode, it is used to move the cursor and change the numeric value. In the menu/text selection mode, it is used for item selection. 																		
	<p>Function Key</p> <ol style="list-style-type: none"> The functions keys have defaults and can also be user-defined. The defaults for F1 and F4 work with the function list below. For example, F1 is JOG function, F4 is a speed setting key for adding/deleting user-defined parameters. Other functions must be defined using TPEditor (Use version 1.40 or later versions). You can download TPEditor software at: http://www.deltaww.com/services/DownloadCenter2.aspx?seclD=8&pid=2&tid=0&CID=06&itemID=060302&typeID=1&downloadID=&title=-- Select Product Series --&dataType=8&check=1&h=en-US <p>Refer to installation instruction for TPEditor in Section 7-13-3.</p>																		
	<p>HAND Key</p> <ol style="list-style-type: none"> The parameter settings for the source of the Hand frequency and hand operation define this key. The defaults for both source of Hand frequency and hand operation are the digital keypad. Press the HAND key at stop status, and the setting switches to hand frequency source and hand operation source. Press HAND key at operation status, and it stops the AC motor drive first (displays AHSP warning), and switches to hand frequency source and hand operation source. Successful mode switching for KPC-CE01, "HAND" LED will be on; for KPC-CC01, it displays HAND mode on the screen. 																		
	<p>AUTO Key</p> <ol style="list-style-type: none"> The parameter settings for the source of the AUTO frequency and auto operation define this key. The default is the external terminal (source of operation is 4–20mA). Press the AUTO key at stop status, and the setting switches to the auto frequency source and auto operation source. Press the AUTO key at operation status, and it stops the AC motor drive first (displays AHSP warning), and switches to auto frequency source and auto operation source. Successful mode switching for KPC-CE01, "AUTO" LED will be on; for KPC-CC01, it displays AUTO mode on the screen 																		

Descriptions of LED Functions

LED	Descriptions
	<p>Steady ON: operation indicator of the AC motor drive, including the DC brake, zero speed, standby, restart after fault and speed search functions.</p> <p>Blinking: drive is decelerating to stop or in Base Block status.</p> <p>Steady OFF: drive does not execute the operation command.</p>
	<p>Steady ON: stop indicator for the AC motor drive.</p> <p>Blinking: drive is in the standby status.</p> <p>Steady OFF: drive does not execute STOP command.</p>
	<p>Operation Direction LED</p> <ol style="list-style-type: none"> 1. Green light: the drive is running forward. 2. Red light: the drive is running backward. 3. Flashing light: the drive is changing direction. <p>Operation Direction LED under Torque Mode</p> <ol style="list-style-type: none"> 1. Green light: when the torque command ≥ 0, and the motor is running forward. 2. Red light: when the torque command < 0, and the motor is running backward. 3. Flashing light: when the torque command < 0, and the motor is running forward.
	<p>(Only KPC-CE01 supports this function)</p> <p>Steady ON: In HAND/ LOC mode</p> <p>Steady OFF: In AUTO/ REM mode</p>
	<p>(Only KPC-CE01 supports this function)</p> <p>Steady ON: In AUTO/ REM mode</p> <p>Steady OFF: In HAND/ LOC mode</p>

7-13-2 Function of Digital Keypad KPC-CC01

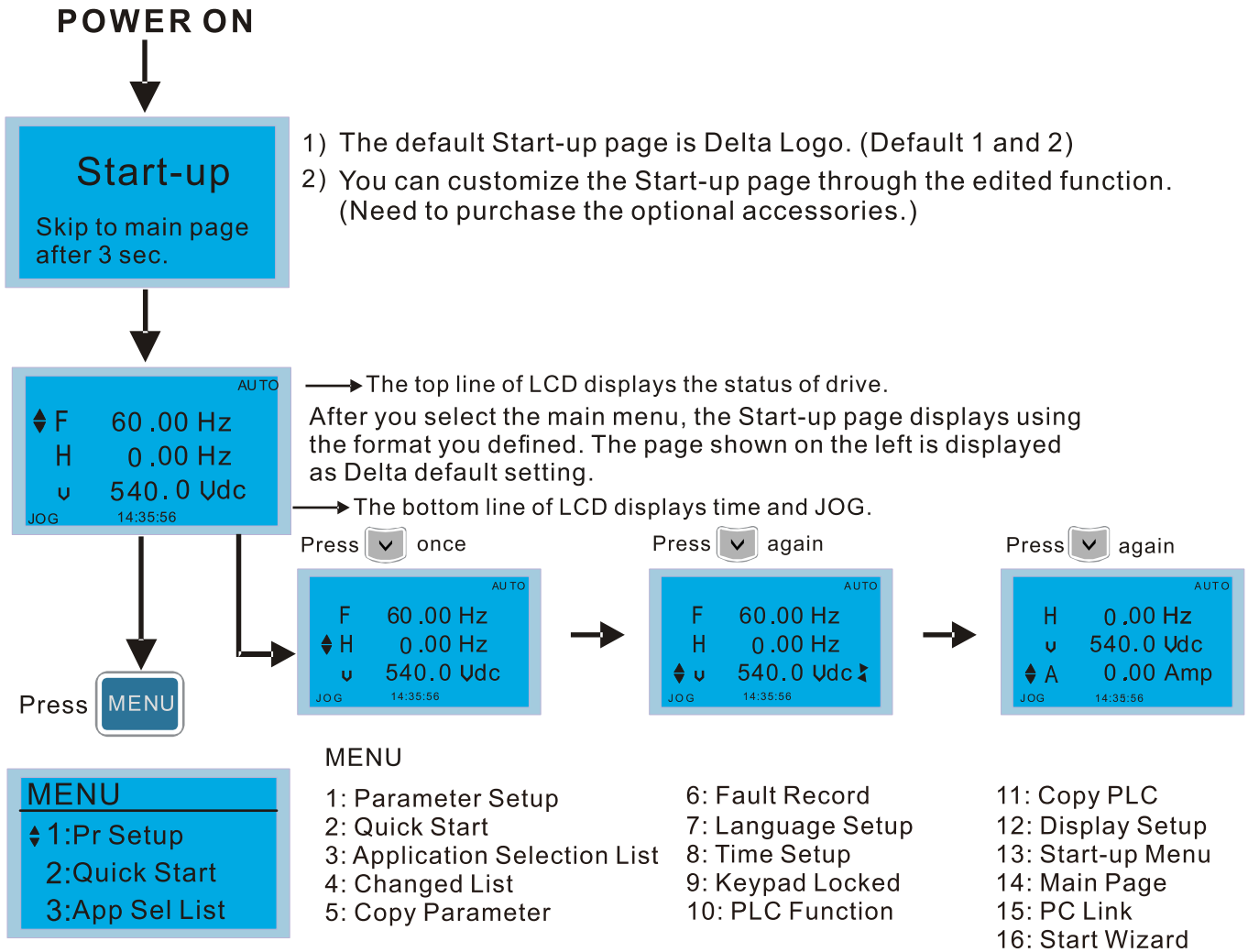

NOTE

1. Start-up page can only display static pictures, but no animation.
2. When Power ON, it displays the Start-up page and then the main page. The main page displays Delta's default setting F/H/A/U. You can set the display order in Pr.00-03 (Select Start-up Display). When the selected item is the U page, use the left/right keys to switch between the items. You can set the display order on the U page in Pr.00.04 (Content of Multi-function Display (User-Defined)).

Display Icon

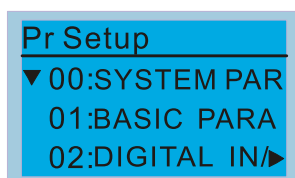
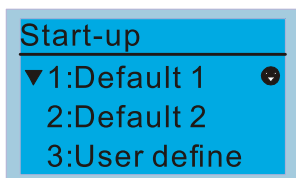



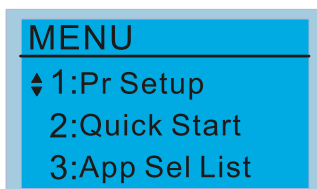

- : present setting
- ▼ : scroll down the page for more options
Press for more options
- ▶ : show complete sentence
Press for complete information

Display item

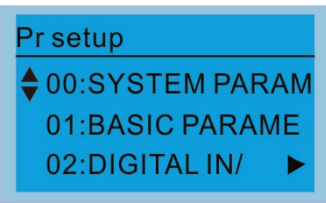

- MENU**
- | | | |
|-------------------------------|-------------------|-------------------|
| 1: Parameter Setup | 6: Fault Record | 11: Copy PLC |
| 2: Quick Start | 7: Language Setup | 12: Display Setup |
| 3: Application Selection List | 8: Time Setup | 13: Start-up Menu |
| 4: Changed List | 9: Keypad Locked | 14: Main Page |
| 5: Copy Parameter | 10: PLC Function | 15: PC Link |
| | | 16: Start Wizard |

1. Parameter Setup

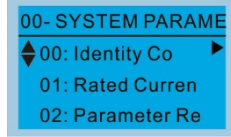
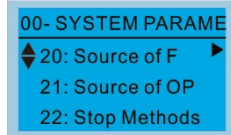
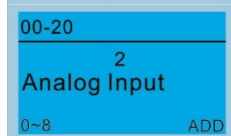
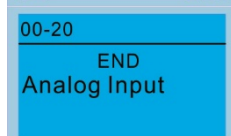
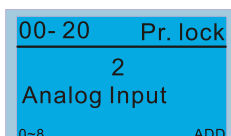
 <p>Press  to select.</p> <p>Press  to select the parameter group.</p> <p>Once you select a parameter group, press  to go into that group.</p>	<p>For example: Set up source of master frequency command.</p>  <p>In the Group 00 Drive Parameters, use Up/Down keys to select parameter 20: Source of F.</p>  <p>Press ENTER to go to this parameter's setting menu.</p>  <p>Use Up/Down keys to choose a setting. For example: Choose "2 Analogue Input", and then press ENTER.</p>  <p>After you press ENTER, "END" displays which means that the parameter setting is done.</p>  <p>NOTE: When parameter lock/password protection function is enabled, "Pr. lock" displays on the right-up corner of the keypad. In this case, it means that the parameter cannot be written or is protected by the password.</p>
--	---

2. Quick Start (ME300 models do not support this function)

3. Application Selection List

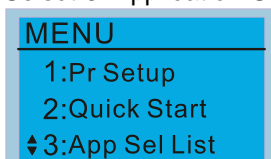
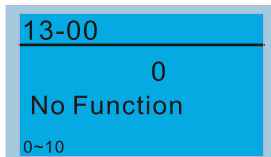
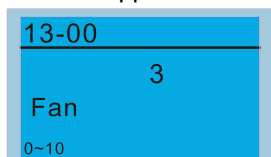
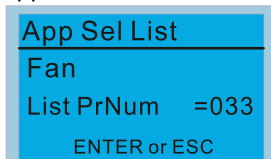
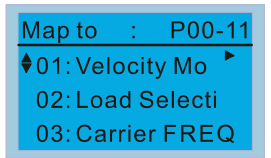
	<p>You can use this function to select application and its parameter settings.</p> <p>For example: Select 3: Application Selection List</p>  <p>Press ENTER to go into the Application Selection List.</p>  <p>Select Application</p>  <p>Press ENTER to enter the application selection screen, and the selected application set is "Fan".</p>  <p>Press ENTER to enter the Fan application set screen.</p>  <p>Press Up/ Down keys to select the parameter.</p>
---	--

	<p>Map to : P00-11</p> <p>01: Velocity Mo ▶</p> <p>02: Load Selecti</p> <p>03: Carrier FREQ</p>	<p>→</p>	<p>Map to : P07-33</p> <p>31: Momentary Po</p> <p>32: Auto Restart</p> <p>33: Reset Resta ▶</p>
	<p>00-16</p> <hr/> <p>0</p> <p>Normal Duty</p> <p>0~1</p>		
<p>Choose 0: Normal duty or 1: Heavy duty according to your needs, and then press ENTER.</p>			

4. Changed List

<p>Changed List</p> <hr/> <p>Changed Pr</p> <p>List PrNum =026</p> <p>ENTER or ESC</p>	<p>This function displays the parameter you set.</p> <p>For example:</p> <p>Set Pr.13-00 Application Selection = 3: Fan.</p>			
	<table border="1" style="width: 100%;"> <tr> <td style="width: 50%;"> <p>13-00</p> <hr/> <p>0</p> <p>No Function</p> <p>0~10</p> </td> <td style="width: 10%; text-align: center;"> <p>→</p> </td> <td style="width: 40%;"> <p>13-00</p> <hr/> <p>3</p> <p>Fan</p> <p>0~10</p> </td> </tr> </table> <p>After you enter the changed list screen, "List PrNum=026" displays and it means there are 26 parameters that have been changed.</p>	<p>13-00</p> <hr/> <p>0</p> <p>No Function</p> <p>0~10</p>	<p>→</p>	<p>13-00</p> <hr/> <p>3</p> <p>Fan</p> <p>0~10</p>
<p>13-00</p> <hr/> <p>0</p> <p>No Function</p> <p>0~10</p>	<p>→</p>	<p>13-00</p> <hr/> <p>3</p> <p>Fan</p> <p>0~10</p>		
	<table border="1" style="width: 100%;"> <tr> <td style="width: 50%;"> <p>Changed List</p> <hr/> <p>Map to : P00-17</p> <p>01: Carrier FREQ ▶</p> <p>02: Source of FR</p> <p>03: Source of OP</p> </td> <td style="width: 50%;"> <p>Press ENTER to enter the changed list screen.</p> <p>Use Up/ Down keys to select the parameters that you need to check or change.</p> </td> </tr> </table> <p>Press ENTER to enter the parameter.</p>	<p>Changed List</p> <hr/> <p>Map to : P00-17</p> <p>01: Carrier FREQ ▶</p> <p>02: Source of FR</p> <p>03: Source of OP</p>	<p>Press ENTER to enter the changed list screen.</p> <p>Use Up/ Down keys to select the parameters that you need to check or change.</p>	
<p>Changed List</p> <hr/> <p>Map to : P00-17</p> <p>01: Carrier FREQ ▶</p> <p>02: Source of FR</p> <p>03: Source of OP</p>	<p>Press ENTER to enter the changed list screen.</p> <p>Use Up/ Down keys to select the parameters that you need to check or change.</p>			
	<table border="1" style="width: 100%;"> <tr> <td style="width: 50%;"> <p>00-17</p> <hr/> <p>4</p> <p>Carrier FREQ</p> <p>2~15</p> </td> <td style="width: 50%;"> <p>KHz</p> </td> </tr> </table>	<p>00-17</p> <hr/> <p>4</p> <p>Carrier FREQ</p> <p>2~15</p>	<p>KHz</p>	
<p>00-17</p> <hr/> <p>4</p> <p>Carrier FREQ</p> <p>2~15</p>	<p>KHz</p>			





5. Copy Parameter

<p>Copy Pr</p> <hr/> <p>001:Manual_001 ▶</p> <p>002:FileName01</p> <p>003:FileName02</p>	<p>Four groups of parameters are available to copy.</p> <p>The steps are shown in the example below.</p> <p>Example: parameter saved in the motor drive.</p>		
<p>Press ENTER to go to 001-004 content storage.</p>	<table border="1" style="width: 100%;"> <tr> <td style="width: 50%;"> <p>Copy pr</p> <hr/> <p>001:Manual_001 ▶</p> <p>002:</p> <p>003:</p> </td> <td style="width: 50%;"> <ol style="list-style-type: none"> 1. Go to "Copy Parameter" 2. Select the parameter group to copy and press ENTER. </td> </tr> </table>	<p>Copy pr</p> <hr/> <p>001:Manual_001 ▶</p> <p>002:</p> <p>003:</p>	<ol style="list-style-type: none"> 1. Go to "Copy Parameter" 2. Select the parameter group to copy and press ENTER.
<p>Copy pr</p> <hr/> <p>001:Manual_001 ▶</p> <p>002:</p> <p>003:</p>	<ol style="list-style-type: none"> 1. Go to "Copy Parameter" 2. Select the parameter group to copy and press ENTER. 		
	<table border="1" style="width: 100%;"> <tr> <td style="width: 50%;"> <p>001></p> <hr/> <p>1: keypad->VFD</p> <p>2: VFD->Keypad</p> </td> <td style="width: 50%;"> <ol style="list-style-type: none"> 1. Select 1: keypad->VFD. 2. Press ENTER to go to the "keypad->VFD" screen. </td> </tr> </table>	<p>001></p> <hr/> <p>1: keypad->VFD</p> <p>2: VFD->Keypad</p>	<ol style="list-style-type: none"> 1. Select 1: keypad->VFD. 2. Press ENTER to go to the "keypad->VFD" screen.
<p>001></p> <hr/> <p>1: keypad->VFD</p> <p>2: VFD->Keypad</p>	<ol style="list-style-type: none"> 1. Select 1: keypad->VFD. 2. Press ENTER to go to the "keypad->VFD" screen. 		

	<p>Begin copying parameters until it is done.</p>
	<p>Once copying parameters is done, the keypad automatically returns to this screen.</p>
<p>Example: parameter saved in the keypad.</p>	
	<ol style="list-style-type: none"> 1. Go to "Copy parameter" 2. Select the parameter group to copy and press ENTER.
	<ol style="list-style-type: none"> 1. Select 2: VFD->keypad. 2. Press ENTER to go to the "VFD->keypad" screen.
	<p>Use Up/ Down keys to select a symbol. Use Left/ Right keys to move the cursor to select a file name.</p>
<p>String & Symbol Table: @ ? < = > ; : 0 1 2 3 4 5 6 7 8 9 / . - ' + * () ' & % \$ # " ! A B C D E F G H I J K L M N O P Q R S T U V W X Y Z [\] ^ _ ` ' ~ { } a b c d e f g h i j k l m n o p q r s t u v w x y z</p>	
	<p>After you confirm the file name, press ENTER.</p>
	<p>Begin copying parameters until it is done.</p>
	<p>After copying parameters, the keypad automatically returns to this screen.</p>
	<p>Press Right key to see the date the parameters were copied.</p>
	<p>Press Right key to see the time the parameters were copied.</p>

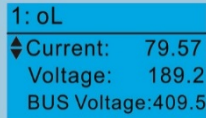
6. Fault Record

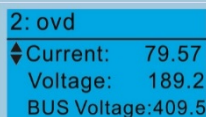
<p>Press to select.</p> <p>KPC-CE01 does not support this function.</p>	<p>Able to store 6 error codes (Keypad V1.02 and previous versions). Able to store 30 error codes (Keypad V1.20 and later version). The most recent error record shows as the first record. Select an error record to see details such as date, time, frequency, current, voltage, and DC BUS voltage.</p> <p>Press Up/ Down keys to select an error record. Press ENTER to see that error record's details.</p>
--	--





	 <p>1: oL ⚡ Current: 79.57 Voltage: 189.2 BUS Voltage: 409.5</p>  <p>1: oL ⚡ Date: 01/20/2014 Time: 21:02:24 Outfreq: 32.61</p>  <p>Fault record 1: oL ⚡ 2: ovd 3: GFF</p>  <p>2: ovd ⚡ Current: 79.57 Voltage: 189.2 BUS Voltage: 409.5</p>  <p>2: ovd ⚡ Date: 01/20/2014 Time: 21:02:24 Outfreq: 32.61</p>  NOTE <p>Fault actions of the AC motor drive are recorded and saved to the KPC-CC01. When you remove the KPC-CC01 and connect it to another AC motor drive, the previous fault records are not deleted. The new fault records of the present AC motor drive continue to be added to the KPC-CC01.</p>	<p>Press Up/ Down keys to scroll through an error record's details such as date, time, frequency, current, voltage, and DC BUS voltage.</p> <p>Press Up/ Down keys to select an error record. Press ENTER to see that error record's details.</p> <p>Press Up/ Down keys to scroll through an error record's details such as date, time, frequency, current, voltage, and DC BUS voltage.</p>
--	--	---

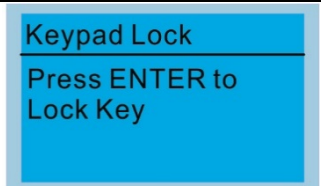

7. Language Setup

 <p>Language ▼ 1: English 2: 繁體中文 3: 简体中文</p> <p>Use Up / Down keys to select the language, and then press ENTER.</p>	<p>The language setting option is displayed in the language of your choice. Language setting options:</p> <table border="0"> <tr> <td>1. English</td> <td>5. Русский</td> </tr> <tr> <td>2. 繁體中文</td> <td>6. Español</td> </tr> <tr> <td>3. 简体中文</td> <td>7. Português</td> </tr> <tr> <td>4. Türkçe</td> <td>8. français</td> </tr> </table>	1. English	5. Русский	2. 繁體中文	6. Español	3. 简体中文	7. Português	4. Türkçe	8. français
1. English	5. Русский								
2. 繁體中文	6. Español								
3. 简体中文	7. Português								
4. Türkçe	8. français								

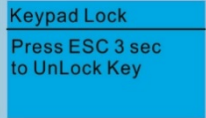
8. Time Setup (ME300 models do not support this function)

9. Keypad Locked

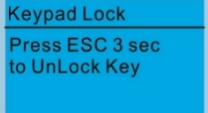





 <p>Keypad Lock Press ENTER to Lock Key</p> <p>Press  to lock.</p>	<p>Lock the keypad</p> <p>Use this function to lock the keypad. The main page does not display "keypad locked" when the keypad is locked; however, it displays the message "Press ESC 3 sec to UnLock Key" when you press any key.</p>  <p>When the keypad is locked, the main screen does not indicate the lock status.</p>  <p>Press any key on the keypad; a message displays as shown on the left.</p>  <p>If you do not press ESC, the keypad automatically returns to this screen.</p>
---	---

	 	<p>At this time, press any key on the keypad, and a message displays as shown on the left.</p> <p>Press ESC for 3 seconds to unlock the keypad and the keypad returns to this screen. All keys on the keypad are functional. Turning the power off and on does not lock the keypad.</p>
--	--	---

10. PLC Function (ME300 models do not support this function)

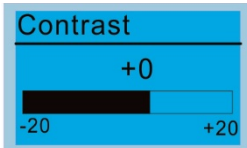
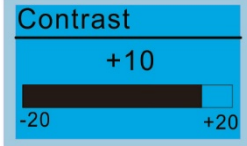

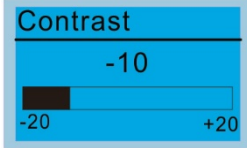
11. Copy PLC (ME300 models do not support this function)

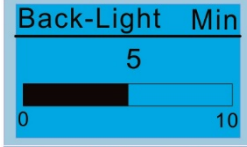
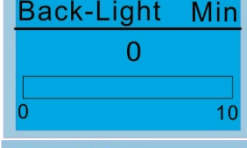
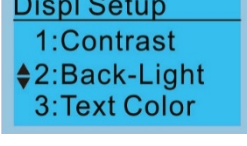
12. Display Setup

 <p>Press  to display the Displ Setup screen.</p>	<p>1. Contrast</p>  <p>Use Up / Down keys to adjust the setting value.</p>  <p>For example, increase Contrast to +10.</p>  <p>After you set the value, press ENTER to see the screen display after contrast is adjusted to +10.</p>  <p>Then press ENTER and decrease the Contrast to -10.</p>  <p>After you set the value, press ENTER to see the screen display after contrast is adjusted to -10.</p> <p>2. Back-light</p>  <p>Press ENTER to go to Back-Light Time Setting screen.</p>  <p>Use Up / Down keys to adjust the setting value.</p>  <p>When the setting value is 0 Min, the backlight remains on.</p>  <p>When the setting value is 10 Min, the backlight turns off in 10 minutes.</p>
---	--

	<p>3. Text Color</p> <div data-bbox="571 165 823 318"> <p>Displ Setup</p> <p>1: Contrast</p> <p>2: Back-Light</p> <p>▲ 3: Text Color</p> </div> <p>Press ENTER to go to the Text Color Setting screen.</p> <div data-bbox="571 336 823 488"> <p>Text Color</p> <p>0</p> <p>White Text</p> <p>0~1</p> </div> <p>The default value is White Text.</p> <div data-bbox="571 506 823 658"> <p>Text Color</p> <p>1</p> <p>Blue Text</p> <p>0~1</p> </div> <p>Use Up / Down keys to adjust the setting value, and then press ENTER.</p> <div data-bbox="571 676 823 828"> <p>Displ Setup</p> <p>▼ 1: Contrast</p> <p>2: Back-Light</p> <p>3: Text Color</p> </div> <p>The setting value changes to Blue Text.</p>
--	--

13. Start-up Menu

<div data-bbox="204 922 517 1106"> <p>Start-up</p> <p>▼ 1. Default 1 ●</p> <p>2. Default 2</p> <p>3. User Define</p> </div>	<p>1. Default 1 DELTA LOGO</p> <div data-bbox="587 972 836 1115">  </div> <p>2. Default 2 DELTA Text</p> <div data-bbox="587 1173 836 1317">  </div> <p>3. User-defined: an optional accessory is required (TPEditor & USB / RS-485 Communication Interface-IFD6530) to design your own Start-up screen. If the editor accessory is not installed, the User Define option displays a blank screen.</p> <div data-bbox="587 1451 836 1594">  </div> <p><u>USB/RS-485 Communication Interface-IFD6530</u> Refer to Chapter 07 Optional Accessories for more details.</p> <p><u>TPEditor</u> Go to Delta's website to download the TPEditor V1.60 or later versions. http://www.deltaww.com/services/DownloadCenter2.aspx?seclD=8&pid=2&tid=0&CID=06&itemID=060302&typeID=1&downloadID=&title=--- Select Product Series ---&dataType=8&check=1&hl=en-US</p>
---	---

14. Main page

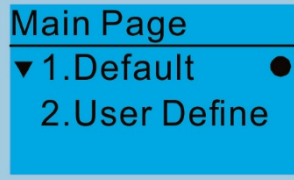

Default screen and editable screen are available.

Press  to select.

1. Default page

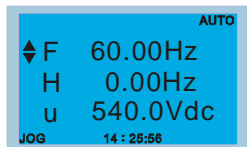

F 60.00 Hz >>> H >>> A >>> U (options rotate)

2. User-defined: an optional accessory is required (TPEditor & USB / RS-485 Communication Interface-IFD6530) to design your own Start-up screen. If the editor accessory is not installed, the User Define option displays a blank screen.

Freq. Hz

Current A

DC BUS Vdc

2014/02/06 14 : 25:56

PID target %

PID feedback %

Output freq. Hz

USB/RS-485 Communication Interface-IFD6530
Refer to Chapter 07 Optional Accessories for more details.

TPEditor
Go to Delta's website to download the TPEditor V1.60 or later versions.
http://www.deltaww.com/services/DownloadCenter2.aspx?s_eclD=8&pid=2&tid=0&CID=06&itmlD=060302&typelD=1&downloadD=&title=-- Select Product Series --&dataType=8&check=1&hl=en-US

15. PC Link



1. TPEditor: This function allows you to connect the keypad to a computer then download and edit user-defined pages.

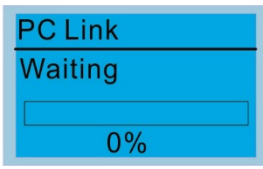

Press ENTER to go to the Waiting to connect to PC screen.

In TPEditor, from the **Communication** menu, choose **Write to TP**.

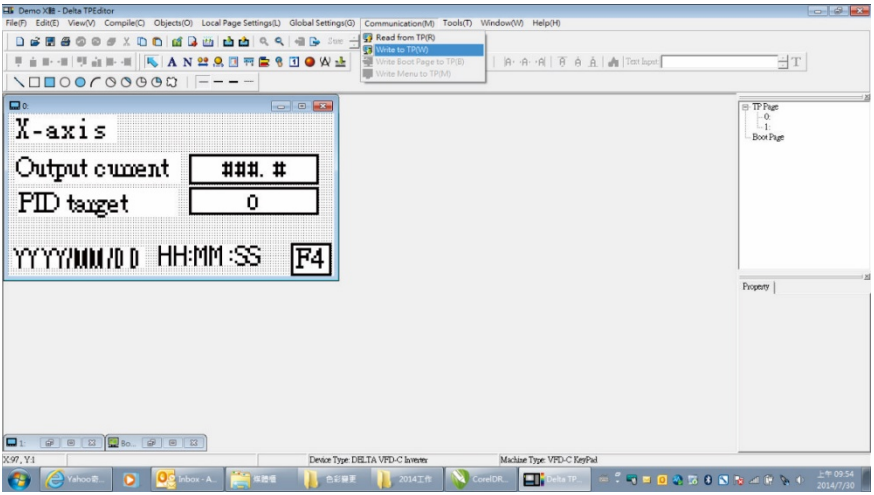

In the **Confirm** message box, click **YES**.

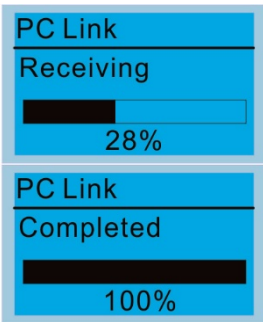
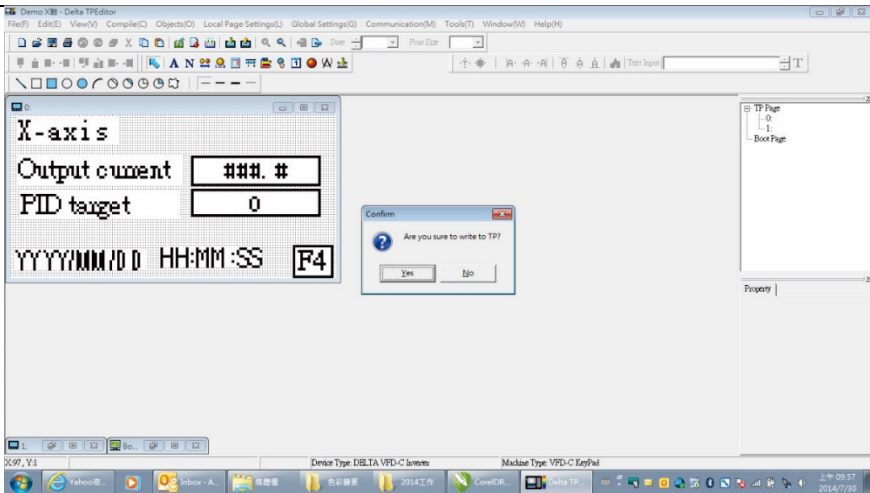

The software starts downloading screens to edit to the KPC-CC01.

Download completed.

2. VFDSOft: this function links to the VFDSOft Operating software, and then you can upload data.

Copy parameter 1–4 in KPC-CC01

NOTE When your computer Operation System (OS) is Windows 10, right-click the VFDSOft icon to enter **Property** (as the red frame shows in the picture below). Then click the **Compatibility** tab and select the **Run this program as an administrator** checkbox (as the red frame shows in the picture below).

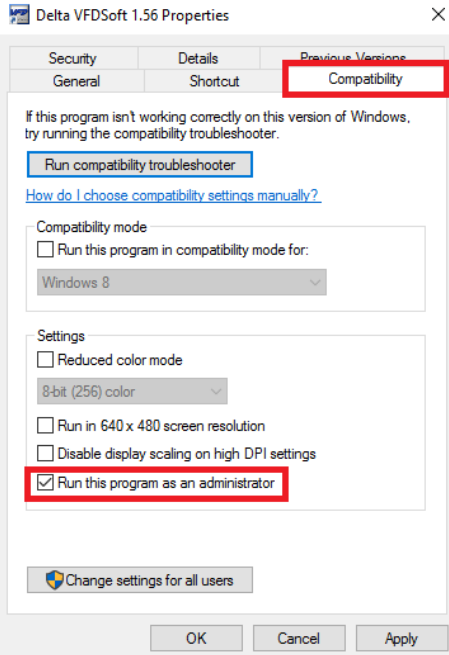

Connect KPC-CC01 to a computer.

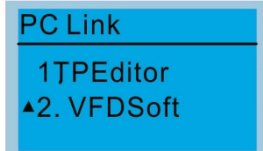

Select 2: VFDSOft and then press ENTER.

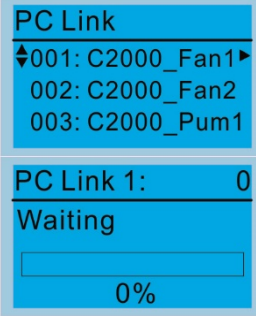

Use Up / Down keys to select a parameter group to upload to VFDSOft.

Press ENTER to display the Waiting to connect to PC screen.

Open VFDSOft and click **Parameter** on the toolbar.

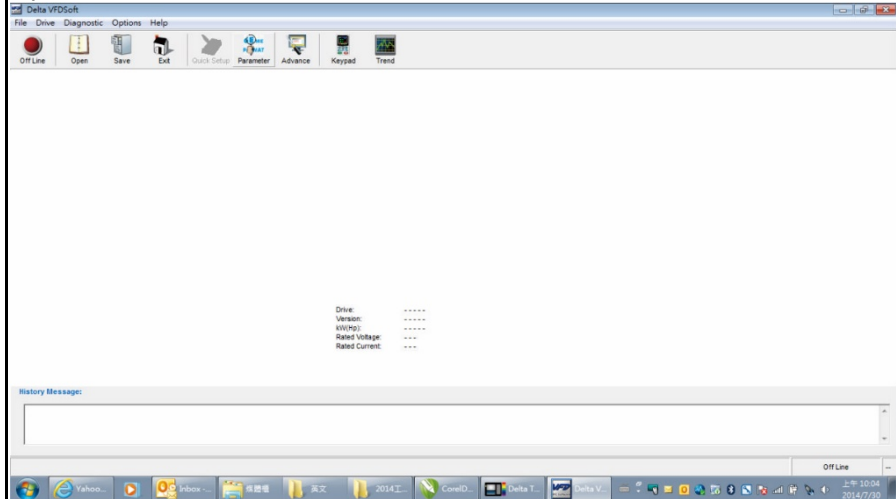

In the Parameter Management, from the **Table** menu, choose **Read from KPC-CC01**.

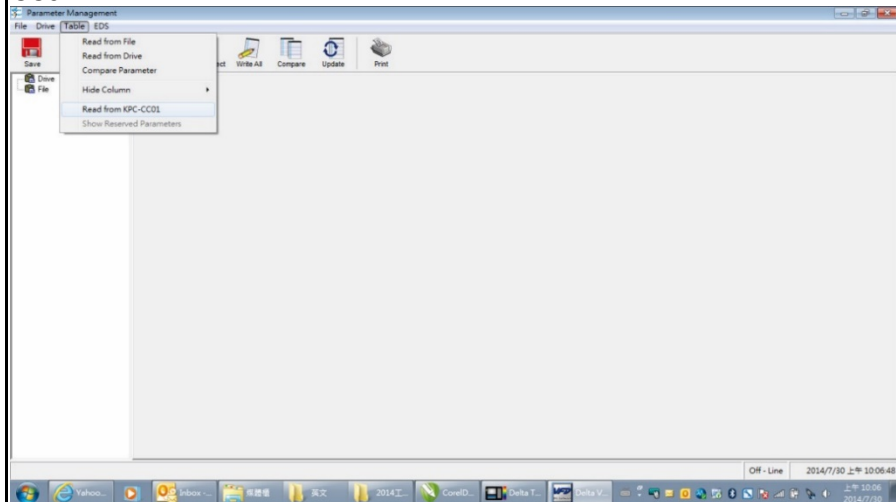

Choose the correct communication port and click **OK**.

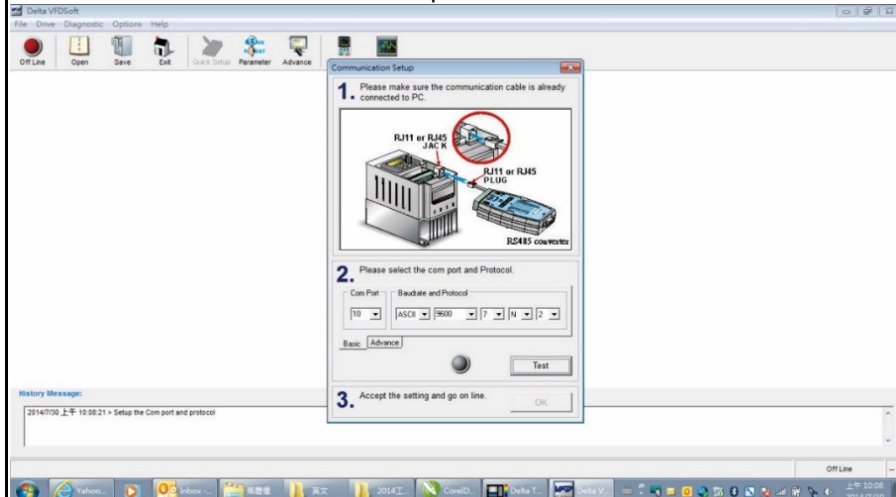

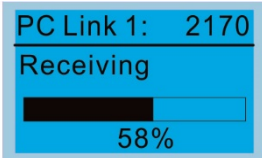
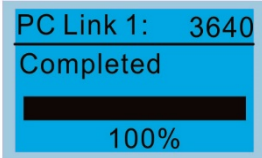
		Start uploading parameters to VFDSOft.
		Uploading parameter is completed.
<p>Before using the user-defined starting screen and user-defined main screen, you must preset the starting screen setup and the main screen setup as user-defined. If you do not download the user-defined screen to the KPC-CC01, the starting screen and the main screen are blank.</p>		

16. Start Wizard (ME300 models do not support this function)

Other display

When a fault occurs, the screen display shows the fault or warning.

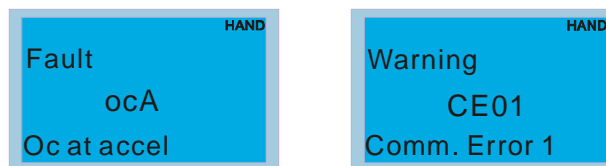

1. Press RESET to reset the fault code. If there is no response, contact your local distributor or return the unit to the factory. To view the fault DC BUS voltage, output current and output voltage, press MENU and then choose Fault Record.
2. After resetting, if the screen returns to main page and shows no fault after you press ESC, the fault is cleared.
3. When the fault or warning message appears, the LED backlight blinks until you clear the fault or warning.

Optional accessory: RJ45 Extension Lead for Digital Keypad

Part No.	Description
CBC-K3FT	RJ45 extension lead, 3 feet (approximately 0.9 m)
CBC-K5FT	RJ45 extension lead, 5 feet (approximately 1.5 m)
CBC-K7FT	RJ45 extension lead, 7 feet (approximately 2.1 m)
CBC-K10FT	RJ45 extension lead, 10 feet (approximately 3 m)
CBC-K16FT	RJ45 extension lead, 16 feet (approximately 4.9 m)

Note: When you need communication cables, buy non-shielded, 24 AWG, four-wire twisted pair, 100 ohms communication cables.

7-13-3 TPEditor Installation Instruction

TPEditor can edit up to 256 HMI (Human-Machine Interface) pages with a total storage capacity of 256 KB. Each page can include 50 normal objects and 10 communication objects.

1) TPEditor: Setup & Basic Functions

1. Run TPEditor version 1.60 or above by double-clicking the program icon.



2. On the **File** menu, click **New**. In the **New Project** dialog box, for **Set Device Type**, select **DELTA VFD-C Inverter**. For **TP Type**, select **VFD-C KeyPad**. For **File Name**, enter TPE0 and then click **OK**.

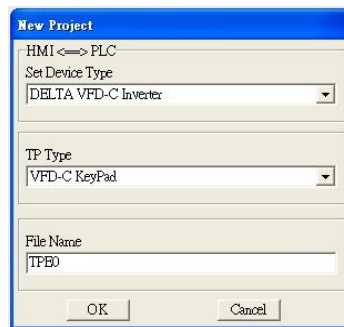

3. The editor displays the Design window. On the **Edit** menu, click **Add a New Page**. You can also right-click on the TP page in the upper right corner of the Design window and click **Add** to add one more page(s) to edit.

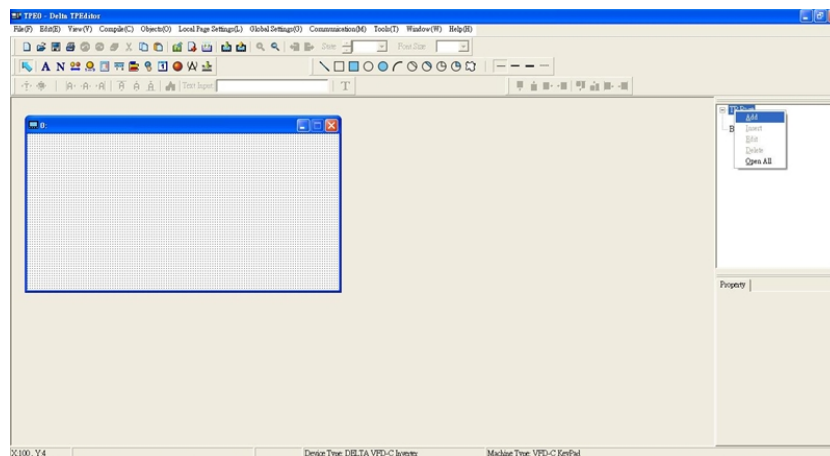

4. Edit the Start-up screen.
5. Add static text. Open a blank page (step 3), then on the toolbar click . Double-click the blank page to display the **Static Text Setting** dialog box, and then enter the static text.

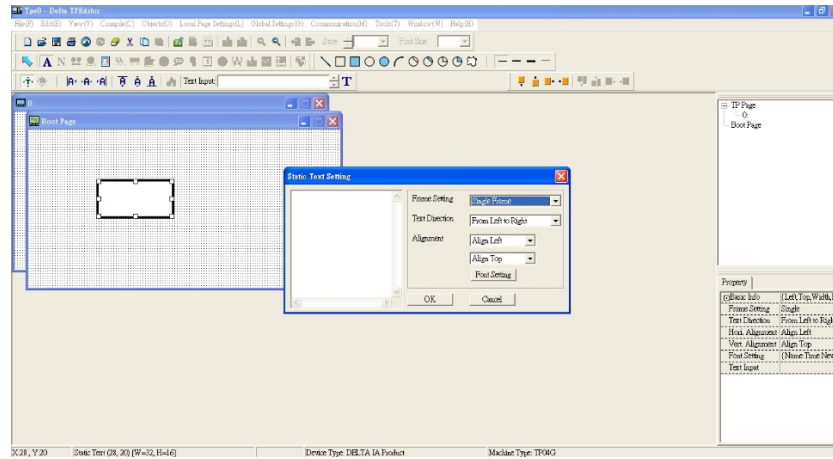

6. Add a static bitmap. Open a blank page (step 3), then on the toolbar, click . Double-click the blank page to display the **Static Bitmap Setting** dialog box where you can choose the bitmap.

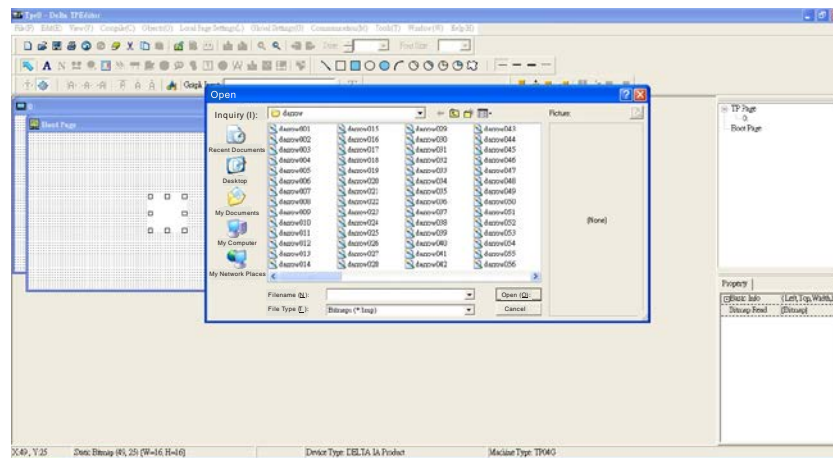

You can only use images in the BMP format. Click the image and then click **Open** to show the image in the page.

7. Add a geometric bitmap. There are 11 kinds of geometric bitmaps to choose. Open a new blank page (step 3), then on the toolbar click the geometric bitmap icon that you need . In the page, drag the geometric bitmap and enlarge it to the size that you need.

8. When you finish editing the Start-up screen, on the **Communication** menu, click **Input User Defined Keypad Starting Screen**.

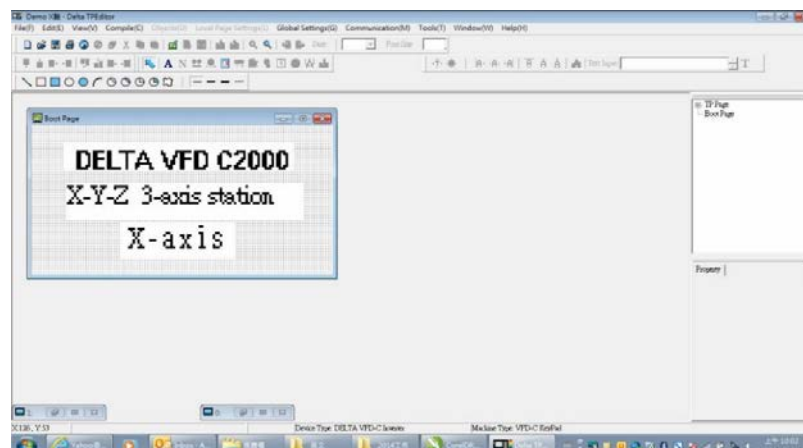

9. Download the new setting: On the **Tool** menu, click **Communication**. Set up the communication port and speed for the IFD6530. There are only three speeds available: 9600 bps, 19200 bps and 38400 bps.
10. On the **Communication** menu, click **Input User Defined Keypad Starting Screen**.

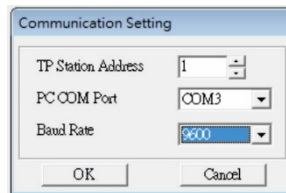

11. The Editor displays a message asking you to confirm the new setting. Before you click **OK**, on the keypad, go to MENU, select PC LINK, press ENTER and then wait for few seconds. Then click **YES** in the confirmation dialog box to start downloading.

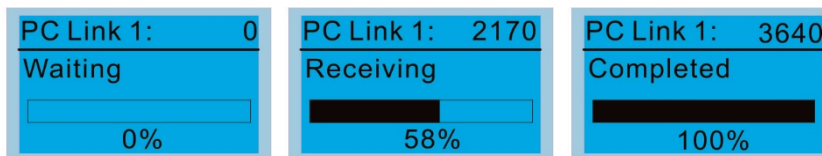
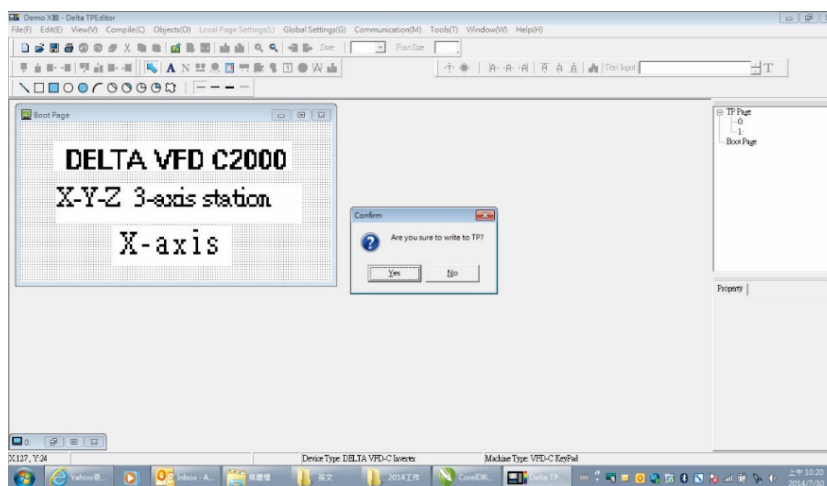

2) Edit the Main Page and Download to the Keypad

1. In the Editor, add a page to edit. On the **Edit** menu, click **Add a New Page**. You can also right-click on the TP page in the upper right corner of the Design window and click **Add** to add one more pages to edit. This keypad currently supports up to 256 pages.

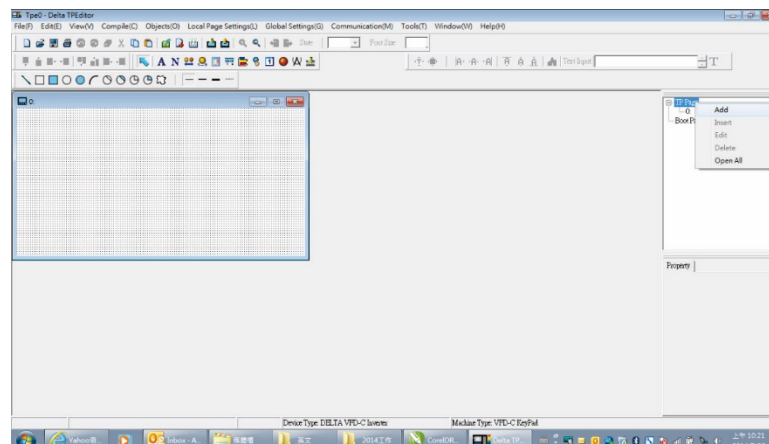

2. In the bottom right-hand corner of the Editor, click the page number to edit, or on the **View** menu, click **HMI Page** to start editing the main page. As shown in the picture above, the following objects are available. From left to right they are: Static Text, ASCII Display, Static Bitmap, Scale, Bar Graph, Button, Clock Display, Multi-state bit map, Units, Numeric Input, the 11 geometric bitmaps, and lines of different widths. Use the same steps to add Static Text, Static Bitmap, and geometric bitmaps as for the Start-up page.



3. Add a numeric/ASCII display. On the toolbar, click the **Numeric/ASCII** button. In the page, double-click the object to specify the **Refer Device**, **Frame Setting**, **Font Setting** and **Alignment**.

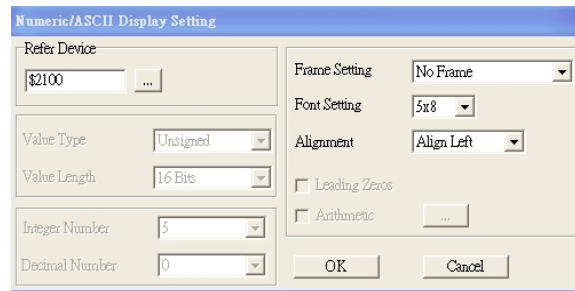

Click [...]. In the **Refer Device** dialog box, choose the VFD communication port that you need. If you want to read the output frequency (H), set the **Absolute Addr.** to 2202. For other values, refer to the ACMD Modbus Comm Address List (see Pr.09-04 in Chapter 12 Group 09 Communication Parameters).

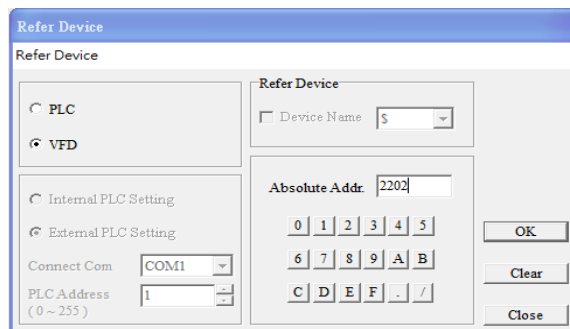

4. Scale Setting. On the toolbar, click  to add a scale. You can also edit the Scale Setting in the Property Window on the right-hand side of your computer screen.

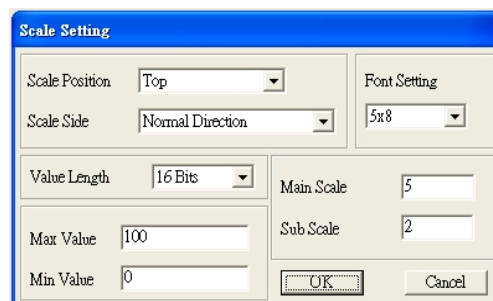

- Scale Position:** specifies where to place the scale.
- Scale Side:** specifies whether the scale is numbered from smaller numbers to larger numbers or from larger to smaller.
- Font Setting:** specifies the font.
- Value Length:** specifies 16 bits or 32 bits.

- e. **Main Scale & Sub-Scale:** divides the whole scale into equal parts; enter the numbers for the main scale and sub-scale.
- f. **Max. Value & Min. Value:** specifies the numbers on the two ends of the scale. They can be negative numbers, but the maximum and minimum values are limited by the **Value Length** setting. For example, when **Value Length** is **hexadecimal (16 bits)**, the maximum and the minimum value cannot be entered as -40000.

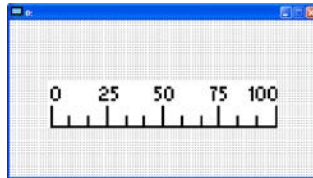

Clicking **OK** creates a scale as in the picture below.

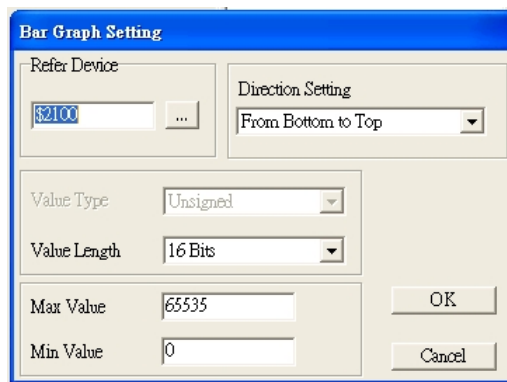

5. Bar Graph setting. On the toolbar, click  to add a bar graph.



- a. **Refer Device:** specifies the VFD communication port.
- b. **Direction Setting:** specifies the direction: **From Bottom to Top**, **From Top to Bottom**, **From Left to Right** or **From Right to Left**.
- c. **Max. Value & Min. Value:** specifies the maximum value and minimum value. A value smaller than or equal to the minimum value causes the bar graph to be blank (0). A value is bigger or equal to the maximum value causes the bar graph is full (100%). A value between the minimum and maximum values causes the bar graph to be filled proportionally.

6. Button: on the toolbar, click . Currently this function only allows the keypad to switch pages; other functions are not yet available (including text input and insert image). In the blank page, double-click  to open the **Button Setting** dialog box.

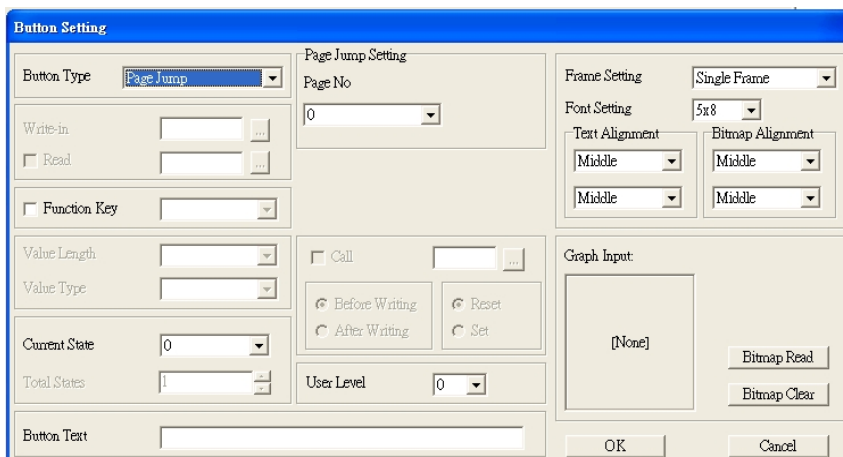

Button Type: specifies the buttons' functions.

Page Jump and **Constant Setting** are the only functions currently supported.

A. Page Jump Setting

- **Page Jump Setting:** in the **Button Type** list, choose **Page Jump** to show the **Page Jump Setting**.
- **Function Key:** specifies the functions for the following keys on the KPC-CC02 keypad: F1, F2, F3, F4, Up, Down, Left and Right. Note that the Up and Down keys are locked by TPEditor. You cannot program these two keys. If you want to program Up and Down keys, on the **Tool** menu, click **Function Key Setting**, and then click **Re-Define Up/Down Key**.

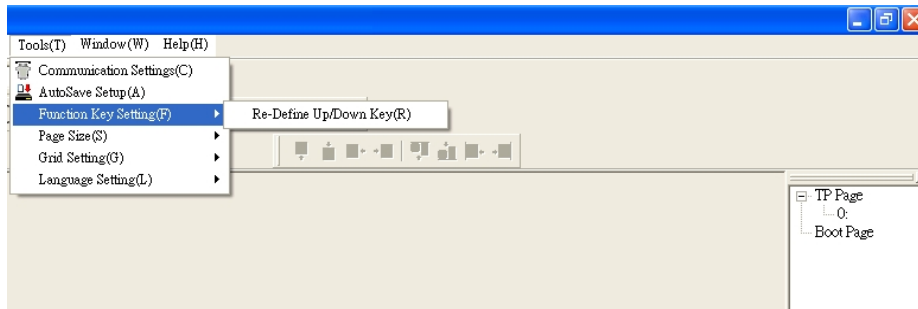

- **Button Text:** specifies the text that appears on a button. For example, when you enter Next Page for the button text, that text appears on the button.

B. Constant Setting

This function specifies the memory address' values for the VFD or PLC. When you press the **Function Key**, it writes a value to the memory address specified by the value for **Constant Setting**. You can use this function to initialize a variable.

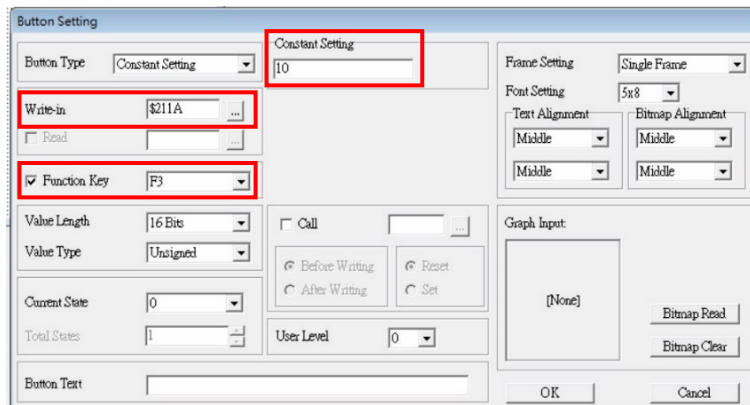

7. **Clock Display Setting:** on the toolbar, click . You can display the time, day, or date on the keypad. Open a new page and click once in that window to add a clock display. Choose to display **Time**, **Day**, or **Date** on the keypad. To adjust time, go to #9 on the keypad's menu. You can also specify the **Frame Setting**, **Font Setting**, and **Alignment**.

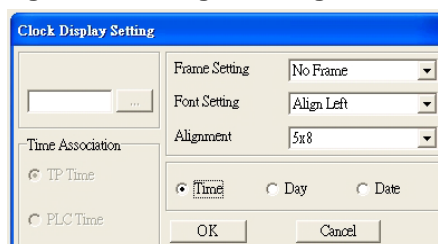

- Multi-state bitmap: on the toolbar, click . The setup window of the multi-state is shown as the image below. This object reads a bit's property value from the PLC (ME300 does not support the PLC function). It defines the image or text that appears when this bit is 0 or 1. Set the initial status (**Current State**) to be 0 or 1 to define the displayed image or text.

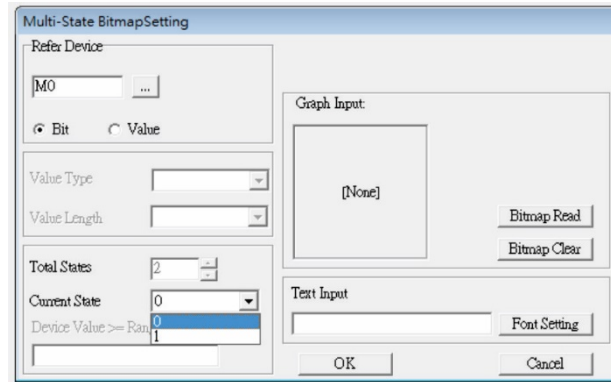

- Unit Measurement: on the toolbar, click . Open a new blank page, and double-click on that window to display the **Units Setting** dialog box.

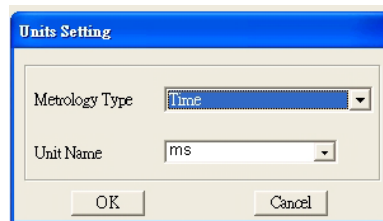

Choose the **Metrology Type** and the **Unit Name**. For **Metrology**, the choices are Length, Square Measure, Volume/Solid Measure, Weight, Speed, Time, and Temperature. The unit name changes automatically when you change metrology type.

- Numeric Input Setting: on the toolbar, click . This object allows you to provide parameters or communication ports and to input numbers. Open a new file and double-click on that window to display the **Numeric Input Setting** dialog box.

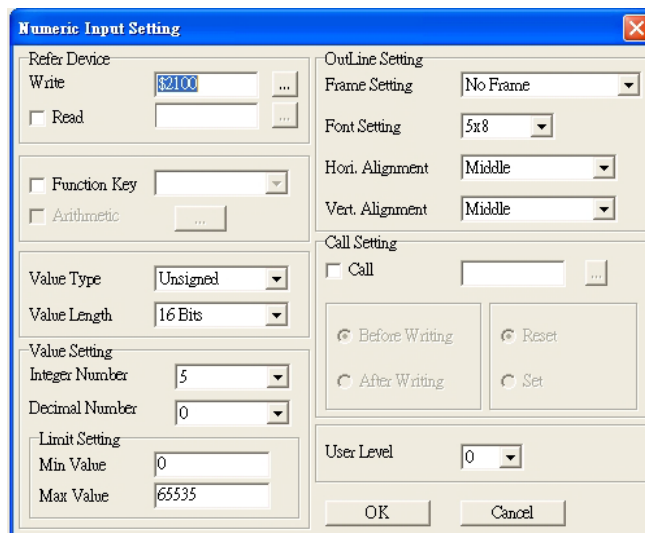

- a. **Refer Device:** specifies the **Write** and the **Read** values. Enter the numbers to display and the corresponding parameter and communication port numbers. For example, enter 012C to Read and Write Parameter Pr.01-44.
- b. **OutLine Setting:** specifies the **Frame Setting**, **Font Setting**, **Hori. Alignment** and **Vert. Alignment** for the outline.
- c. **Function key:** specifies the function key to program on the keypad in the **Function Key** box. The corresponding key on the keypad starts to blink. Press ENTER to confirm the setting.
- d. **Value Type & Value Length:** specify the range of the **Min. Value** and **Max. Value** for the **Limit Setting**.
- e. **Value Setting:** automatically set by the keypad itself.
- f. **Limit Setting:** specifies the range for the numeric input here.

For example, if you set **Function Key** to **F1**, **Min. Value** to 0 and **Max. Value** to 4, when you press F1 on the keypad, then you can press Up/Down on the keypad to increase or decrease the value. Press ENTER on the keypad to confirm your setting. You can also view the parameter table 01-44 to verify if you correctly entered the value.

11. **Download TP Page:** Press Up/Down keys on the keypad to select #13 PC Link.

Then press ENTER on the keypad. The screen displays "Waiting". In TPEditor, choose a page that you have created, and then on the **Communication** menu click **Write to TP** to start downloading the page to the keypad.

When you see "Completed" on the keypad screen, the download is finished. You can then press ESC on the keypad to return to the menu screen.

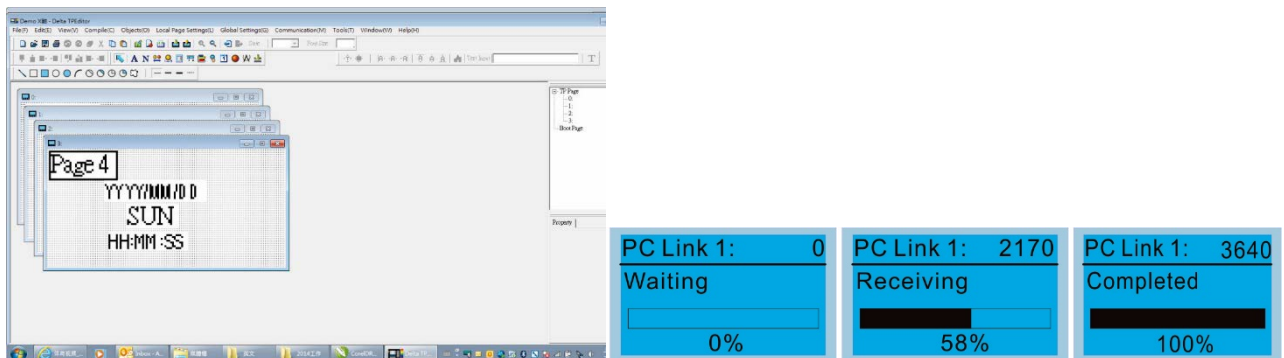

7-13-4 Digital Keypad KPC-CC01 Fault Codes and Descriptions

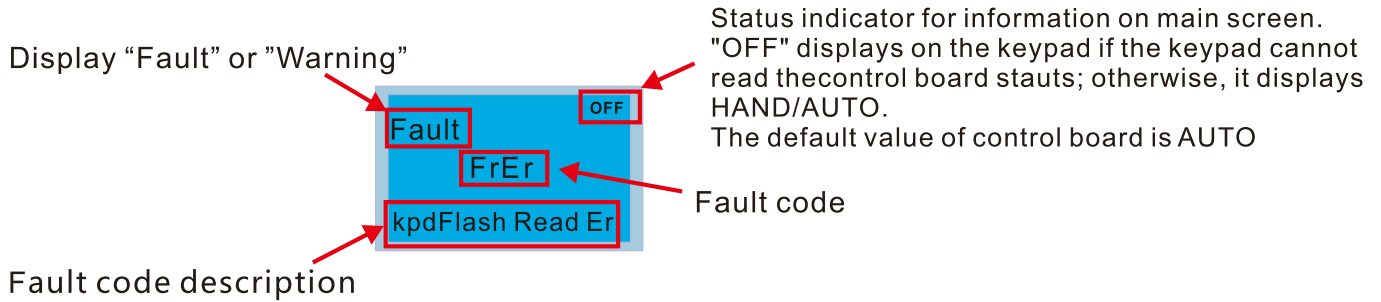

Fault Codes

LCM Display *	Description	Corrective Actions
	Keypad flash memory read error	An error in the keypad's flash memory. 1. Press RESET to clear the errors. 2. Check for any problem on Flash IC. 3. Shut down the system, wait for ten minutes, and then restart the system. If none of the above solutions work, contact your authorized local dealer for assistance.
	Keypad flash memory save error	An error in the keypad's flash memory. 1. Press RESET to clear the errors. 2. Verify if there's any problem on Flash IC. 3. Shut down the system, wait for ten minutes, and then restart the system. If none of the above solutions work, contact your authorized local dealer for assistance.
	Keypad flash memory parameter error	An error in the default parameters. It might be caused by firmware update. 1. Press RESET to clear the errors. 2. Check for any problem on Flash IC. 3. Shut down the system, wait for ten minutes, and then restart the system. If none of the above solutions work, contact your local authorized dealer for assistance.
	Keypad error when reading AC drive data	Keypad cannot read any data sent from the VFD. 1. Verify that the keypad is properly connected to the motor drive by a communication cable such as RJ45. 2. Press RESET to clear the errors. 3. Shut down the system, wait for ten minutes, and then restart the system. If none of the above solutions work, contact your local authorized dealer for assistance.
	Critical error in keypad's CPU	A serious error in the keypad's CPU. 1. Check for any problem on CPU clock. 2. Check for any problem on Flash IC. 3. Check for any problem on RTC IC. 4. Verify that the communication quality of the RS-485 cable is good. 5. Shut down the system, wait for ten minutes, and then restart the system. If none of the above solutions work, contact your local authorized dealer for assistance.

Warning Codes

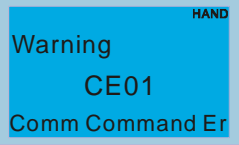
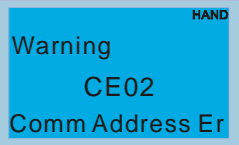
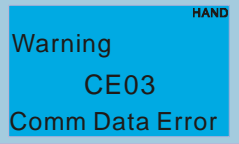
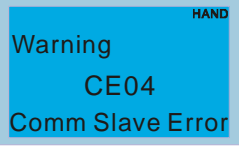
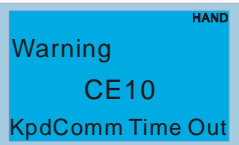
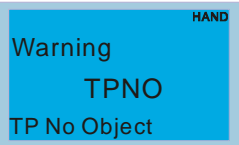
LCM Display *	Description	Corrective Actions
 <p>Warning CE01 Comm Command Er</p>	Modbus function code error	<p>Motor drive does not accept the communication command from the keypad.</p> <ol style="list-style-type: none"> 1. Verify that the keypad is properly connected to the motor drive by a communication cable such as RJ45. 2. Press RESET to clear the errors. <p>If none of the above solutions work, contact your local authorized dealer for assistance.</p>
 <p>Warning CE02 Comm Address Er</p>	Modbus data address error	<p>Motor drive does not accept keypad's communication address.</p> <ol style="list-style-type: none"> 1. Verify that the keypad is properly connected to the motor drive by a communication cable such as RJ45. 2. Press RESET to clear the errors. <p>If none of the above solutions work, contact your local authorized dealer for assistance.</p>
 <p>Warning CE03 Comm Data Error</p>	Modbus data value error	<p>Motor drive does not accept the communication data from the keypad.</p> <ol style="list-style-type: none"> 1. Verify that the keypad is properly connected to the motor drive by a communication cable such as RJ45. 2. Press RESET to clear the errors. <p>If none of the above solutions work, contact your local authorized dealer for assistance.</p>
 <p>Warning CE04 Comm Slave Error</p>	Modbus slave drive error	<p>Motor drive cannot process the communication command from the keypad.</p> <ol style="list-style-type: none"> 1. Verify that the keypad is properly connected to the motor drive by a communication cable such as RJ45. 2. Press RESET to clear the errors. 3. Shut down the system, wait for ten minutes, and then restart the system. <p>If none of the above solutions work, contact your local authorized dealer for assistance.</p>
 <p>Warning CE10 KpdComm Time Out</p>	Modbus transmission time-out	<p>Motor drive does not respond to the communication command from the keypad.</p> <ol style="list-style-type: none"> 1. Verify that the keypad is properly connected to the motor drive by a communication cable such as RJ45. 2. Press RESET to clear the errors. 3. Shut down the system, wait for ten minutes, and then restart the system. <p>If none of the above solutions work, contact your local authorized dealer for assistance.</p>
 <p>Warning TPNO TP No Object</p>	Object not supported by TPEditor	<p>Keypad's TPEditor uses an unsupported object or Drive series.</p> <ol style="list-style-type: none"> 1. Verify that the TPEditor is not using an unsupported object or setting. Delete unsupported objects and unsupported settings. 2. Re-edit the object in the TPEditor and then download it to the keypad. 3. Make sure the Drive series support the TP functions. If it does not, the main screen displays the default. <p>If none of the above solutions work, contact your local authorized dealer for assistance.</p>



NOTE The warning code CExx only occurs when the communication problem is between the drive and the keypad. It has nothing to do with the drive and other devices. Note the warning code description to find the cause of the error if CExx appears.

File Copy Setting Fault Description

These faults occur when KPC-CC01 cannot perform the command after clicking the ENTER button in the copy function.

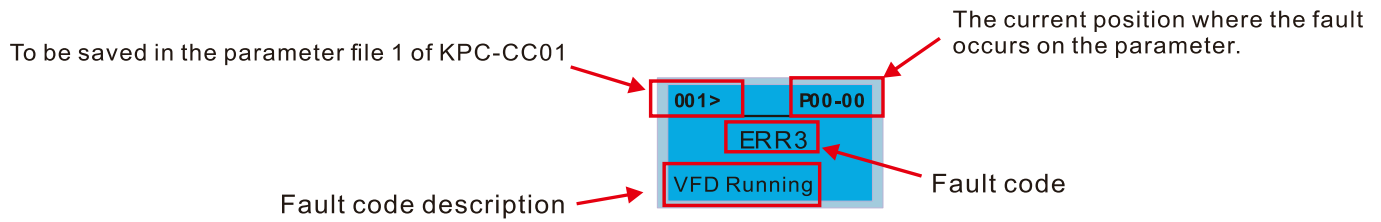

LCM Display *	Description	Corrective Actions
<div style="border: 1px solid black; padding: 5px; background-color: #e0f0ff;"> <p>001> P00-00</p> <p>ERR1</p> <p>Read Only</p> </div>	Parameter and file are read only	The property of the parameter / file is read-only and cannot be written to. 1. Verify the specification in the user manual. If the above solution does not work, contact your local authorized dealer for assistance.
<div style="border: 1px solid black; padding: 5px; background-color: #e0f0ff;"> <p>001> P00-00</p> <p>ERR2</p> <p>Write Fail</p> </div>	Fail to write parameter and file	An error occurred while writing to a parameter / file. 1. Check for any problem on the Flash IC. 2. Shut down the system, wait for ten minutes, and then restart the system. If none of the above solutions work, contact your local authorized dealer for assistance.
<div style="border: 1px solid black; padding: 5px; background-color: #e0f0ff;"> <p>001> P00-00</p> <p>ERR3</p> <p>VFD Running</p> </div>	AC drive is in operating status	A setting cannot be changed while motor drive is in operation. 1. Verify that the drive is not in operation. If the above solution does not work, contact your local authorized dealer for assistance.
<div style="border: 1px solid black; padding: 5px; background-color: #e0f0ff;"> <p>001> P00-00</p> <p>ERR4</p> <p>Pr Lock</p> </div>	AC drive parameter is locked	A setting cannot be changed because a parameter is locked. 1. Check if the parameter is locked or not. If it is locked, unlock it and try to change the parameter again. If the above solution does not work, contact your local authorized dealer for assistance.
<div style="border: 1px solid black; padding: 5px; background-color: #e0f0ff;"> <p>001> P00-00</p> <p>ERR5</p> <p>Pr Changing</p> </div>	AC drive parameter changing	A setting cannot be changed because a parameter is being modified. 1. Check if the parameter is being modified. If it is not being modified, try to change that parameter again. If the above solution does not work, contact your local authorized dealer for assistance.
<div style="border: 1px solid black; padding: 5px; background-color: #e0f0ff;"> <p>001> P00-00</p> <p>ERR6</p> <p>Fault Code</p> </div>	Fault code	A setting cannot be changed because an error has occurred in the motor drive. 1. Check if there is any error in the motor drive. If there is not any error, try to change the setting again. If the above solution does not work, contact your local authorized dealer for assistance.
<div style="border: 1px solid black; padding: 5px; background-color: #e0f0ff;"> <p>001> P00-00</p> <p>ERR7</p> <p>Warning Code</p> </div>	Warning code	A setting cannot be changed because of a warning message given to the motor drive. 1. Check if there is any warning message given to the motor drive. If the above solution does not work, contact your local authorized dealer for assistance.
<div style="border: 1px solid black; padding: 5px; background-color: #e0f0ff;"> <p>001> P00-00</p> <p>ERR8</p> <p>Type Dismatch</p> </div>	File type mismatch	Data to be copied is not the correct type, so the setting cannot be changed. 1. Check if the products' serial numbers to be copied are in the same category. If they are in the same category, try to change the setting again. If the above solution does not work, contact your authorized dealer for assistance.

LCM Display *	Description	Corrective Actions
<div style="border: 1px solid black; padding: 5px; background-color: #e0f0ff;"> <p>001> P00-00</p> <p>ERR9</p> <p>Password Lock</p> </div>	File is locked with password	<p>A setting cannot be changed because some data are locked.</p> <ol style="list-style-type: none"> 1. Check if the data are unlocked or able to be unlocked. If the data are unlocked, try to change the setting again. 2. Shut down the system, wait for ten minutes, and then restart the system. <p>If none of the above solutions work, contact your local authorized dealer for assistance.</p>
<div style="border: 1px solid black; padding: 5px; background-color: #e0f0ff;"> <p>001> P00-00</p> <p>ERR10</p> <p>Password Fail</p> </div>	File password failure	<p>A setting cannot be changed because the password is incorrect.</p> <ol style="list-style-type: none"> 1. Check if the password is correct. If the password is correct, try to change the setting again. 2. Shut down the system, wait for ten minutes, and then restart the system. <p>If none of the above solutions work, contact your local authorized dealer for assistance</p>
<div style="border: 1px solid black; padding: 5px; background-color: #e0f0ff;"> <p>001> P00-00</p> <p>ERR11</p> <p>Version Fail</p> </div>	File version mismatch	<p>A setting cannot be changed because the version of the data is incorrect.</p> <ol style="list-style-type: none"> 1. Check if the version of the data matches the motor drive. If it matches, try to change the setting again. <p>If the above solution does not work, contact your local authorized dealer for assistance.</p>
<div style="border: 1px solid black; padding: 5px; background-color: #e0f0ff;"> <p>001> P00-00</p> <p>ERR12</p> <p>VFD Time Out</p> </div>	AC drive copy function time-out	<p>A setting cannot be changed because the data copying time-out expired.</p> <ol style="list-style-type: none"> 1. Try copying the data again. 2. Check if copying data is allowed. If it is allowed, try to copy the data again. 3. Shut down the system, wait for ten minutes, and then restart the system. <p>If none of the above solutions work, contact your local authorized dealer for assistance.</p>

※ The content in this chapter only applies to KPC-CC01 keypad V1.01 and later version(s).

7-13-5 Unsupported Functions when Using TPEditor with the KPC-CC01

1. **Local Page Setting** and **Global Setting** functions are not supported.

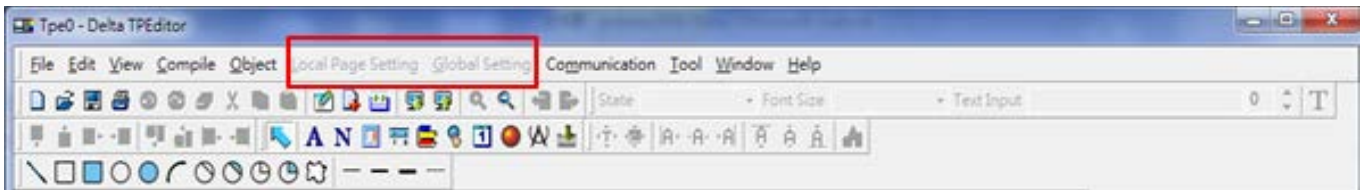

2. In the **Communication** menu, **Read from TP** function is not supported.

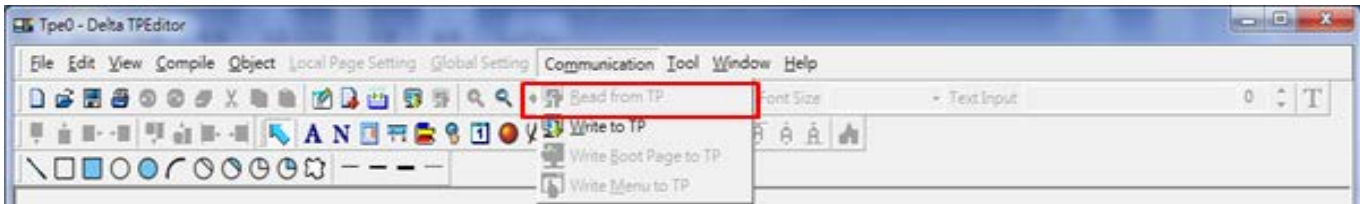

3. In the **RTC Display Setting**, you cannot change the **Refer Device**.

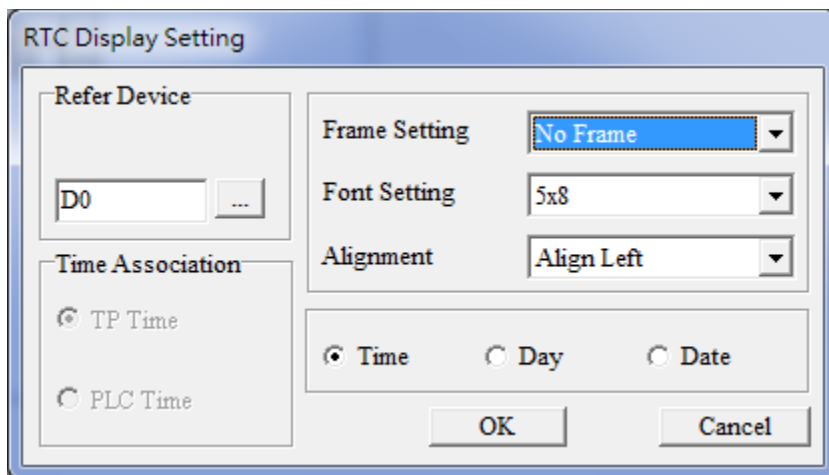

Chapter 8 Option Cards

8-1 Option Card Installation

8-2 EMM-SAF01 -- STO Card, Safe Torque Off

The option cards in this chapter are optional items. Select the applicable option cards for your motor drive, or contact your local distributor for suggestions. The option cards can significantly improve the efficiency of the motor drive. To prevent damage to the motor drive during installation, remove the digital keypad and the cover before wiring.

8-1 Option Card Installation

1. As shown in Figure 8-1, switch off the power of the motor drive, and then remove the front cover.
2. Mounting the connector: as shown in Figure 8-2, aim the adapter/option card at the connector on the control board, and then insert it to the connector.
3. As shown in Figure 8-3, make sure that the clip is properly engage the adapter/option card, and then fasten the screw (Suggested torque value: 4–6 kg-cm [3.5–5.2 lb-in.] [0.39–0.59 Nm]).
4. As shown in Figure 8-4, assembly is completed.

Note: detaching the option cards: detach the option card with slotted screwdriver at position A and B. Slotted screwdriver specifications: 2.5 mm (wide) x 0.4 mm (thick), as shown in Figure 8-5.

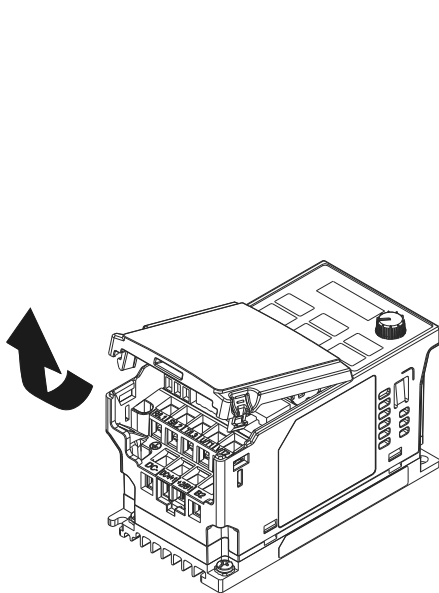

Figure 8-1

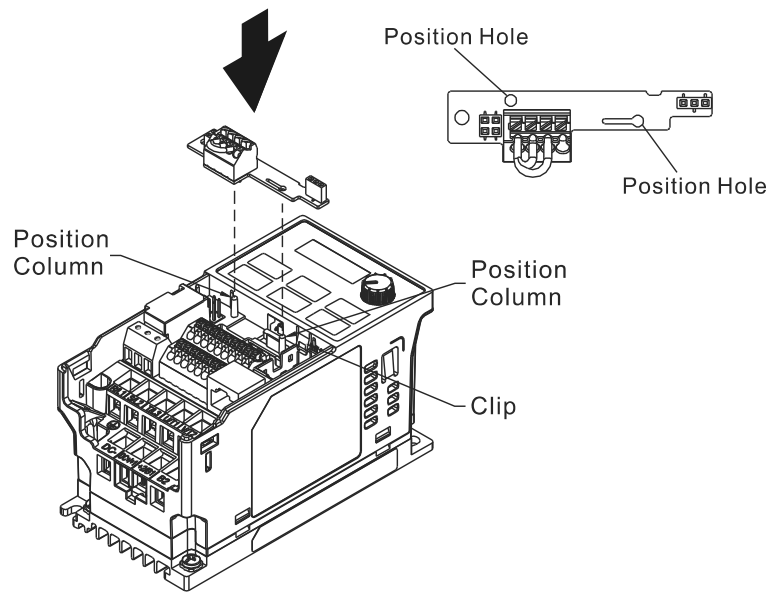

Figure 8-2

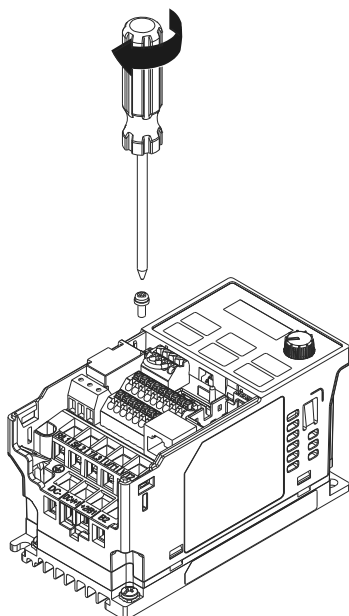

Figure 8-3

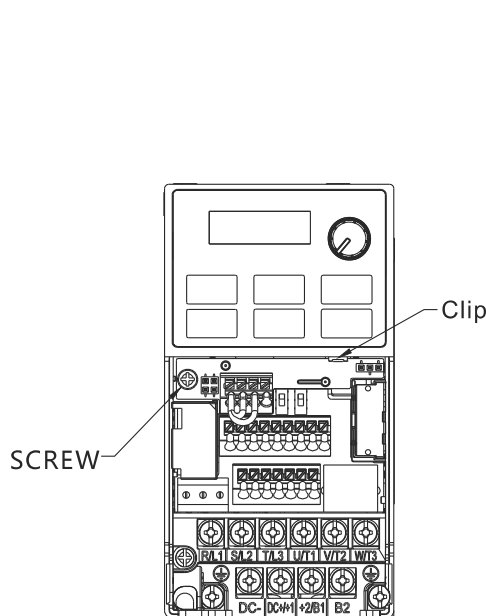

Figure 8-4

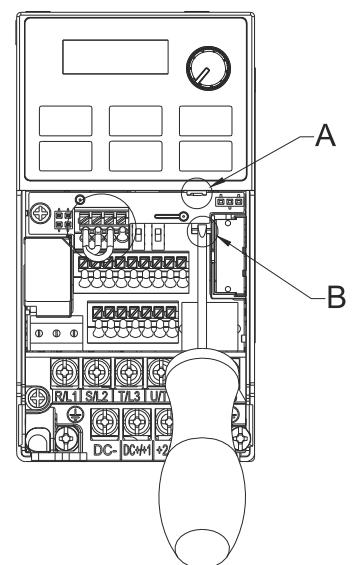
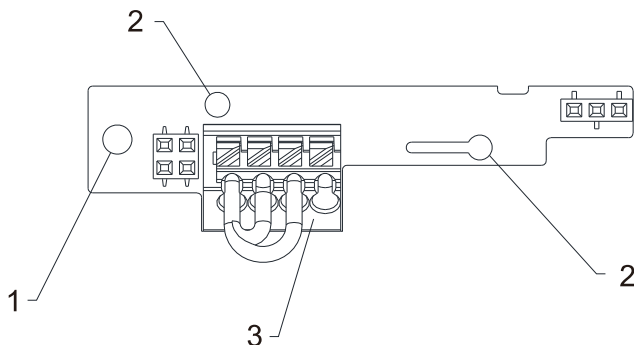
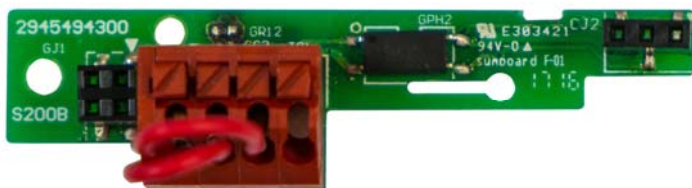

Figure 8-5

8-2 EMM-SAF01

Product Profile



- 1. Screw fixing hole
- 2. Positioning hole
- 3. STO terminal block

Wire: 0.25–0.75 mm² [24–18 AWG]
 Stripping length: 9 mm

Features

- 1. Safe Torque Off function
- 2. After installing this option card, the drive meets the following international standards.
 - ISO 13849-1: 2015 Category 3 PL d
 - IEC 61508 SIL2
 - EN 62061 SIL CL 2

Specifications

Network Interface

+24V	Digital control signal common (Source)
S1, S2	Default: S1/S2 shorted for +24 V Rated voltage: 24 V _{DC} ±10%; Maximum voltage: 30 V _{DC} Activation current: 6.67 mA ±10% STO activation mode Input voltage level: S1-DCM > 0 V _{DC} or S2-DCM < 5 V _{DC} STO response time ≤ 20 ms. S1/S2 operates until the AC motor drive stops outputting current. STO cut-off mode Input voltage level: S1-DCM > 11 V _{DC} and S2-DCM < 30 V _{DC} Power removal safety function according to EN 954-1 and IEC/EN 61508 Note: refer to user manual Chapter 15 SAFE TORQUE OFF FUNCTION for more information.
DCM	Digital frequency signal common (Sink)

Electrical Specification

Power supply voltage	24 V _{DC} (+24 V from motor drive ±10% 100 mA)
Insulation voltage	500 V _{DC}
Power consumption	0.8 W
Weight	25 g

Environment

Noise immunity	ESD (IEC 61800-5-1, IEC 6100-4-2) EFT (IEC 61800-5-1, IEC 6100-4-4) Surge Test (IEC 61800-5-1, IEC 6100-4-5) Conducted Susceptibility Test (IEC 61800-5-1, IEC 6100-4-6)
Operation / Storage	Operation: -10–50°C (temperature), 90% (humidity) Storage: -25–70°C (temperature), 95% (humidity)
Shock / Vibration resistance	International standards: IEC 61131-2, IEC 68-2-6 (TEST Fc) / IEC 61131-2 & IEC 68-2-27 (TEST Ea)

Chapter 9 Specification

9-1 115V Series

9-2 230V Series

9-3 460V Series

9-4 General Specifications

9-5 Environment for Operation, Storage and Transportation

9-6 Derating for Ambient Temperature and Altitude

9-1 115V Series

115V, one-phase

Frame		A			C	
Model VFD___ ME11□AA		0A8	1A6	2A5	4A8	
		ANN ANS	ANN ANS	ANN ANS	ANN ANS	
Applicable Motor Output (kW)		0.1	0.2	0.4	0.75	
Applicable Motor Output (HP)		1/8	1/4	1/2	1	
Output Rating	Heavy duty	Rated Output Capacity (kVA)	0.4	0.6	1.0	1.8
		Rated Output Current (A)	0.8	1.6	2.5	4.8
		Carrier Frequency (kHz)	2-15			
	Normal Duty	Rated Output Capacity (kVA)	0.4	0.7	1.0	2.1
		Rated Output Current (A)	1.0	1.8	2.7	5.5
		Carrier Frequency (kHz)	2-15			
Input Rating	Rated Input Current (A)	Heavy Duty	3.0	6.0	9.4	18
		Normal Duty	3.7	6.8	10.1	20.6
	Rated Voltage / Frequency	One-phase AC 100-120 V (-15- +10%), 50/60 Hz				
	Operating Voltage Range (V _{AC})	85-132				
	Frequency Range (Hz)	47-63				
Weight (kg)		0.4	0.4	0.5	1	
Cooling Method		Convective cooling			Fan cooling	
EMC Filter		Optional				
Ingress Protection Rating		IP20				



NOTE

- The value of the carrier frequency is set in the factory. To increase the carrier frequency, decrease the current. See the derating curve diagram for Pr.06-55 for more information.
- When the load is a shock or impact load, use a higher level model.

9-2 230V Series

230V, one-phase

Frame		A	B	A	B	A	B
Model VFD___ ME21 <input type="checkbox"/> AA		0A8		1A6		2A8	
		<input type="checkbox"/> ANN <input type="checkbox"/> ANS	<input type="checkbox"/> AFN <input type="checkbox"/> AFS	<input type="checkbox"/> ANN <input type="checkbox"/> ANS	<input type="checkbox"/> AFN <input type="checkbox"/> AFS	<input type="checkbox"/> ANN <input type="checkbox"/> ANS	<input type="checkbox"/> AFN <input type="checkbox"/> AFS
Applicable Motor Output (kW)		0.1		0.2		0.4	
Applicable Motor Output (HP)		1/8		1/4		1/2	
Output Rating	Heavy duty	Rated Output Capacity (kVA)	0.3		0.6		1.1
		Rated Output Current (A)	0.8		1.6		2.8
		Carrier Frequency (kHz)	2–15				
	Normal Duty	Rated Output Capacity (kVA)	0.4		0.7		1.2
		Rated Output Current (A)	1.0		1.8		3.2
		Carrier Frequency (kHz)	2–15				
Input Rating	Rated Input Current (A)	Heavy Duty	2.2		3.4		5.9
		Normal Duty	2.8		3.8		6.7
	Rated Voltage / Frequency		One-phase AC 200–240 V (-15– +10%), 50/60 Hz				
	Operating Voltage Range (V _{AC})		170–265				
	Frequency Range (Hz)		47–63				
Weight (kg)		0.4	0.9	0.4	0.9	0.5	0.9
Cooling Method		Convective cooling			Fan cooling		
EMC Filter		Optional	Built-in	Optional	Built-in	Optional	Built-in
Ingress Protection Rating		IP20					

Frame		B	C				
Model VFD___ ME21 <input type="checkbox"/> AA		4A8		7A5		11A	
		<input type="checkbox"/> ANN <input type="checkbox"/> ANS	<input type="checkbox"/> AFN <input type="checkbox"/> AFS	<input type="checkbox"/> ANN <input type="checkbox"/> ANS	<input type="checkbox"/> AFN <input type="checkbox"/> AFS	<input type="checkbox"/> ANN <input type="checkbox"/> ANS	<input type="checkbox"/> AFN <input type="checkbox"/> AFS
Applicable Motor Output (kW)		0.75		1.5		2.2	
Applicable Motor Output (HP)		1		2		3	
Output Rating	Heavy duty	Rated Output Capacity (kVA)	1.8		2.9		4.2
		Rated Output Current (A)	4.8		7.5		11
		Carrier Frequency (kHz)	2–15				
	Normal Duty	Rated Output Capacity (kVA)	1.9		3.2		4.8
		Rated Output Current (A)	5		8.5		12.5
		Carrier Frequency (kHz)	2–15				
Input Rating	Rated Input Current (A)	Heavy Duty	10.1		15.8		23.1
		Normal Duty	10.5		17.9		26.3
	Rated Voltage / Frequency		One-phase AC 200–240 V (-15– +10%), 50/60 Hz				
	Operating Voltage Range (V _{AC})		170–265				
	Frequency Range (Hz)		47–63				
Weight (kg)		0.8	0.9	1	1.5	1	1.5
Cooling Method		Convective cooling			Fan cooling		
EMC Filter		Optional	Built-in	Optional	Built-in	Optional	Built-in
Ingress Protection Rating		IP20					

NOTE

- The value of the carrier frequency is set in the factory. To increase the carrier frequency, decrease the current. See the derating curve diagram for Pr.06-55 for more information.
- When the load is a shock or impact load, use a higher level model.

230V, three-phase

Frame		A				
Model VFD___ME23□AA		0A8	1A6	2A8	4A8	
		ANN ANS	ANN ANS	ANN ANS	ANN ANS	
Applicable Motor Output (kW)		0.1	0.2	0.4	0.75	
Applicable Motor Output (HP)		1/8	1/4	1/2	1	
Output Rating	Heavy duty	Rated Output Capacity (kVA)	0.3	0.6	1.1	1.8
		Rated Output Current (A)	0.8	1.6	2.8	4.8
		Carrier Frequency (kHz)	2-15			
	Normal Duty	Rated Output Capacity (kVA)	0.4	0.7	1.2	1.9
		Rated Output Current (A)	1.0	1.8	3.2	5
		Carrier Frequency (kHz)	2-15			
Input Rating	Rated Input Current (A)	Heavy Duty	2.2	1.9	3.4	5.8
		Normal Duty	2.8	2.2	3.8	6.0
	Rated Voltage / Frequency		Three-phase AC 200-240 V (-15- +10%), 50/60 Hz			
	Operating Voltage Range (V _{AC})		170-265			
	Frequency Range (Hz)		47-63			
Weight (kg)		0.4	0.4	0.45	0.6	
Cooling Method		Convective cooling				
EMC Filter		Optional				
Ingress Protection Rating		IP20				

Frame		B	C		D	
Model VFD___ME23□AA		7A5	11A	17A	25A	
		ANN ANS	ANN ANS	ANN ANS	ANN ANS	
Applicable Motor Output (kW)		1.5	2.2	3.7	5.5	
Applicable Motor Output (HP)		2	3	5	7.5	
Output Rating	Heavy duty	Rated Output Capacity (kVA)	2.9	4.2	6.5	9.5
		Rated Output Current (A)	7.5	11	17	25
		Carrier Frequency (kHz)	2-15			
	Normal Duty	Rated Output Capacity (kVA)	3.0	4.8	7.4	10.3
		Rated Output Current (A)	8.0	12.5	19.5	27
		Carrier Frequency (kHz)	2-15			
Input Rating	Rated Input Current (A)	Heavy Duty	9.0	13.2	20.4	30
		Normal Duty	9.6	15	23.4	32.4
	Rated Voltage / Frequency		Three-phase AC 200-240 V (-15- +10%), 50/60 Hz			
	Operating Voltage Range (V _{AC})		170-265			
	Frequency Range (Hz)		47-63			
Weight (kg)		0.8	1	1	2	
Cooling Method		Fan cooling				
EMC Filter		Optional				
Ingress Protection Rating		IP20				

 **NOTE**

- The value of the carrier frequency is set in the factory. To increase the carrier frequency, decrease the current. See the derating curve diagram for Pr.06-55 for more information.
- When the load is a shock or impact load, use a higher level model.

9-3 460V Series

460V, three-phase

Frame		A	B	A	B	B			
Model VFD___ ME43 <input type="checkbox"/> AA		1A5		2A7		4A2			
		<input type="checkbox"/> ANN <input type="checkbox"/> ANS	<input type="checkbox"/> AFN <input type="checkbox"/> AFS	<input type="checkbox"/> ANN <input type="checkbox"/> ANS	<input type="checkbox"/> AFN <input type="checkbox"/> AFS	<input type="checkbox"/> ANN <input type="checkbox"/> ANS	<input type="checkbox"/> AFN <input type="checkbox"/> AFS		
Applicable Motor Output (kW)		0.4		0.75		1.5			
Applicable Motor Output (HP)		1/2		1		2			
Output Rating	Heavy duty	Rated Output Capacity (kVA)		1.1		2.1		3.2	
		Rated Output Current (A)		1.5		2.7		4.2	
		Carrier Frequency (kHz)		2–15					
	Normal Duty	Rated Output Capacity (kVA)		1.4		2.3		3.5	
		Rated Output Current (A)		1.8		3		4.6	
		Carrier Frequency (kHz)		2–15					
Input Rating	Rated Input Current (A)	Heavy Duty		1.7		3.0		4.6	
		Normal Duty		2.0		3.3		5.1	
	Rated Voltage / Frequency		Three-phase AC 380–480 V (-15– +10%), 50/60 Hz						
	Operating Voltage Range (V _{AC})		323–528						
	Frequency Range (Hz)		47–63						
Weight (kg)		0.55	0.9	0.7	0.9	0.8	0.9		
Cooling Method		Convective cooling	Fan cooling	Convective cooling	Fan cooling				
EMC Filter		Optional	Built-in	Optional	Built-in	Optional	Built-in		
Ingress Protection Rating		IP20							

Frame		C				D					
Model VFD___ ME43 <input type="checkbox"/> AA		5A5		9A0		13A		17A			
		<input type="checkbox"/> ANN <input type="checkbox"/> ANS <input type="checkbox"/> AFN <input type="checkbox"/> AFS	<input type="checkbox"/> ANN <input type="checkbox"/> ANS <input type="checkbox"/> AFN <input type="checkbox"/> AFS	<input type="checkbox"/> ANN <input type="checkbox"/> ANS <input type="checkbox"/> AFN <input type="checkbox"/> AFS	<input type="checkbox"/> ANN <input type="checkbox"/> ANS <input type="checkbox"/> AFN <input type="checkbox"/> AFS	<input type="checkbox"/> ANN <input type="checkbox"/> ANS <input type="checkbox"/> AFN <input type="checkbox"/> AFS	<input type="checkbox"/> ANN <input type="checkbox"/> ANS <input type="checkbox"/> AFN <input type="checkbox"/> AFS	<input type="checkbox"/> ANN <input type="checkbox"/> ANS <input type="checkbox"/> AFN <input type="checkbox"/> AFS			
Applicable Motor Output (kW)		2.2		3.7		5.5		7.5			
Applicable Motor Output (HP)		3		5		7.5		10			
Output Rating	Heavy duty	Rated Output Capacity (kVA)		4.2		6.9		9.9		13	
		Rated Output Current (A)		5.5		9		13		17	
		Carrier Frequency (kHz)		2–15							
	Normal Duty	Rated Output Capacity (kVA)		5.0		8.0		12		15.6	
		Rated Output Current (A)		6.5		10.5		15.7		20.5	
		Carrier Frequency (kHz)		2–15							
Input Rating	Rated Input Current (A)	Heavy Duty		6.1		9.9		14.3		18.7	
		Normal Duty		7.2		11.6		17.3		22.6	
	Rated Voltage / Frequency		Three-phase AC 380–480 V (-15– +10%), 50/60 Hz								
	Operating Voltage Range (V _{AC})		323–528								
Frequency Range (Hz)		47–63									
Weight (kg)		1	1.5	1	1.5	2	2.7	2	2.7		
Cooling Method		Fan cooling									
EMC Filter		Optional	Built-in	Optional	Built-in	Optional	Built-in	Optional	Built-in		
Ingress Protection Rating		IP20									

NOTE

- The value of the carrier frequency is set in the factory. To increase the carrier frequency, decrease the current. See the derating curve diagram for Pr.06-55 for more information.
- When the load is a shock or impact load, use a higher level model.

9-4 General Specifications

Control Characteristics	Control Method	V/F, SVC, FOC, V/F+PG, FOC+PG, TQC+PG
	Applied Motor	IM (Induction Motor), PM motor control (IPM and SPM)
	Max. Output Frequency	0.00–599.00 Hz
	Starting Torque [Note 1]	150% / 3 Hz (V/F, SVC, V/F+PG control for IM, Heavy duty) 100% / (1/20 of motor rated frequency) (SVC control for PM, Heavy duty)
	Speed Control Range [Note 1]	1: 5 (V/F, SVC, V/F+PG control for IM, Heavy duty) 1: 20 (SVC control for PM, Heavy duty)
	Overload Capability	Normal duty: 120% 60 sec., 150% 3 sec. Heavy duty: 150% 60 sec., 200% 3 sec.
	Frequency Setting Signal	0–10 V / 4(0)–20 mA PWM pulse width input, pulse input (10 kHz).
	Main Function	Multiple motor switches (Two independent motor parameter settings), Fast start-up, Deceleration Energy Back (DEB) function, Fast deceleration function, Master and Auxiliary frequency source selectable, Momentary power loss ride thru, Speed search, Over-torque detection, Torque limit, 16-step speed (max.), Accel./decel. time switch, S-curve accel./decel., three-wire sequence, JOG frequency, Upper/lower limits for frequency reference, DC injection braking at start and stop, PID control, Positioning function.
	Application Macro	Built-in application parameter groups (selected by industry) and user-defined application parameter groups.
Protection Characteristics	Motor Protection	Over-current, Over-voltage, Over-temperature, Phase loss, Over-load
	Stall Prevention	Stall prevention during acceleration, deceleration and running (independent settings)
Accessory		STO (Safe Torque Off) card [Note 2]
Certifications		UL, CE, C-Tick, TÜV (SIL 2) [Note 3], RoHS, REACH

[Note 1] Control accuracy may vary depending on the environment, application conditions or different motors.

For details, contact our company or your local distributor.

[Note 2] The optional STO is applicable for VFD___ME____N__ models without built-in STO.

[Note 3] The international certification TUV (SIL 2) is applicable for VFD___ME____S__ models with built-in STO.

9-5 Environment for Operation, Storage and Transportation

DO NOT expose the AC motor drive to bad environmental conditions, such as dust, direct sunlight, corrosive/ inflammable gasses, humidity, liquid or vibration. The salt in the air must be less than 0.01 mg/ cm ² every year.				
Environment	Installation location	IEC60364-1/ IEC60664-1 Pollution degree 2, Indoor use only.		
	Surrounding Temperature	Operation	IP20 / UL Open Type	-20–50°C -20–60°C (Derating required)
			IP20 installed side by side	-20–40°C
			NEMA 1 / UL Type 1	-20–55°C (Derating required)
		Storage	-40–85°C	
		Transportation	-20–70°C	
	Non-condensing, non-freezing			
	Rated Humidity	Operation	Max. 90%	
		Storage / Transportation	Max. 95%	
		No condense water		
	Air Pressure	Operation	86–106 kPa	
		Storage / Transportation	70–106 kPa	
	Pollution Level	Operation	Class 3C2; Class 3S2	
		Storage	Class 2C2; Class 2S2	
		Transportation	Class 1C2; Class 1S2	
Concentrate prohibited				
Altitude	Operable at altitude below 1000 m (derating if operated over 1000 m)			
Package Drop	Storage	ISTA procedure 1A (according to weight) IEC 60068-2-31		
	Transportation			
Vibration	Operating	1.0 mm, peak to peak value range from 2–13.2 Hz; 0.7–1.0 G range from 13.2–55 Hz; 1.0 G range from 55–512 Hz; complies with IEC 60068-2-6.		
	Non-operating	2.5 G peak 5 Hz–2 kHz 0.015" maximum displacement		
Impact	Operating	15 G, 11 ms; complies with IEC / EN 60068-2-27.		
	Non-operating	30 G		

9-6 Derating for Ambient Temperature and Altitude

- Derating for Ambient Temperature

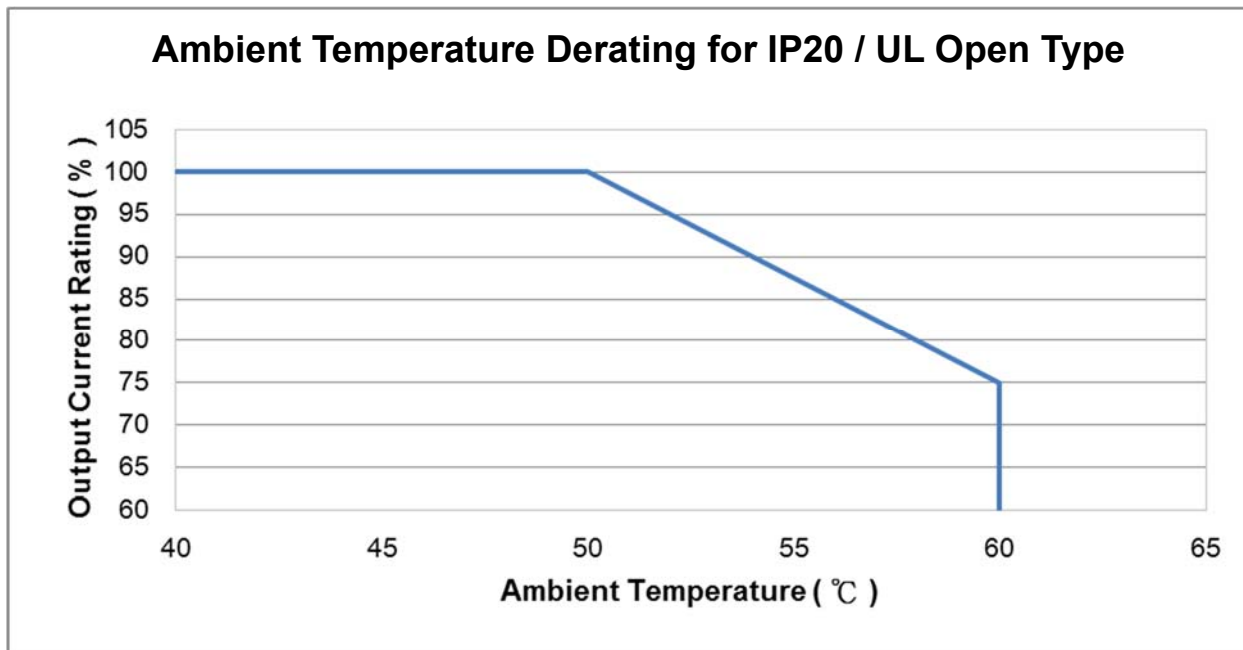

At the rated current the ambient temperature is -10– +50°C.

Over 50°C, decrease the rated current 2.5%/°C up to 60°C.

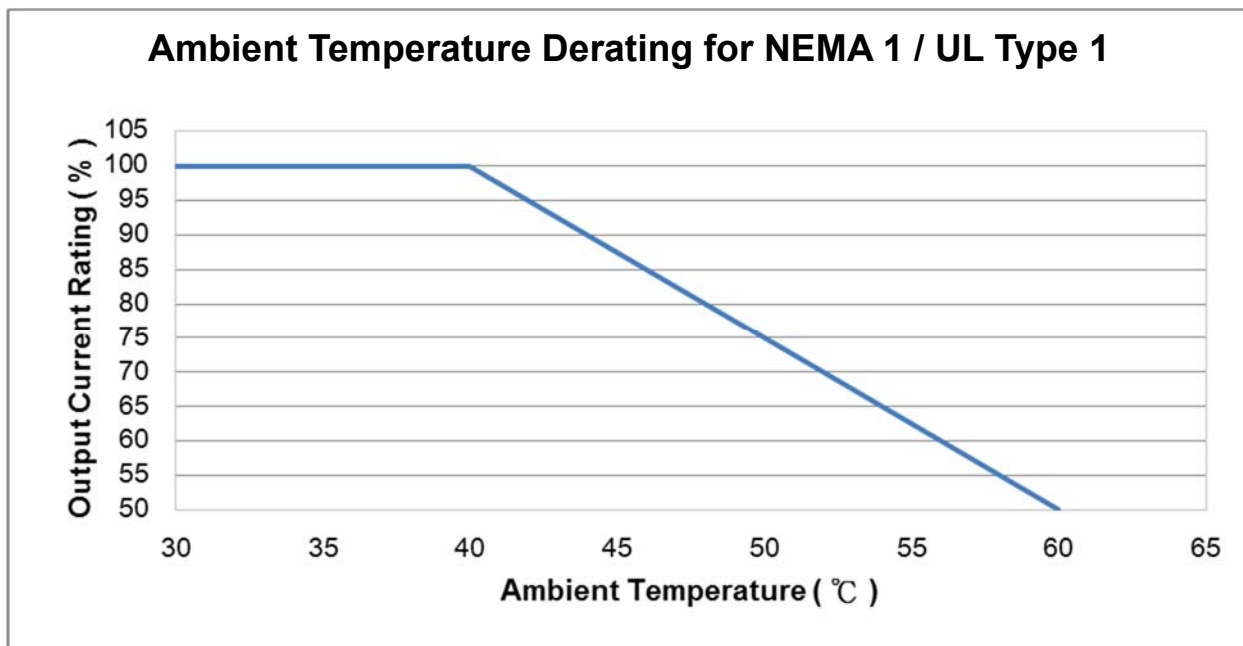

At the rated current the ambient temperature is -10– +40°C.

Over 40°C, decrease the rated current 2.5%/°C up to 60°C.

● Derating for Altitude

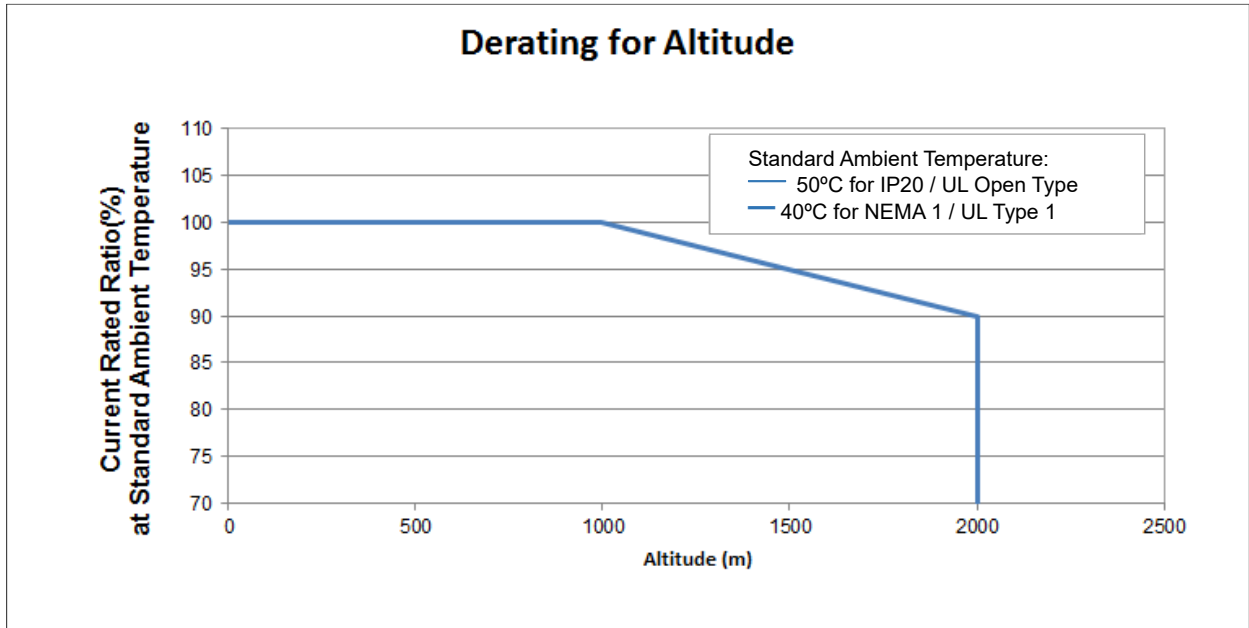

For IP20 / UL Open Type

Current derating at ambient temperature				
Ambient temperature		40°C	45°C	50°C
Operating altitude above sea level (m)	0–1000	100%		
	1001–1500	100%		95%
	1501–2000	100%	95%	90%

NEMA1 / UL Type 1

Current derating at ambient temperature				
Ambient temperature		30°C	35°C	40°C
Operating altitude above sea level (m)	0–1000	100%		
	1001–1500	100%		95%
	1501–2000	100%	95%	90%

Operating Conditions	Ambient Temperature Limits
IP20 / UL Open Type	When the AC motor drive is operating at the rated current, the ambient temperature must be between -20– +50°C. When the temperature is over 50°C, for every increase by 1°C, decrease the rated current 2.5%. The maximum allowable temperature is 60°C.
NEMA1 / UL Type 1	When the AC motor drive is operating at the rated current, the ambient temperature must be between -20– +40°C. When the temperature is over 40°C, for every increase by 1°C, decrease the rated current 2.5%. The maximum allowable temperature is 60°C.
High Altitude	If the AC motor drive is installed at an altitude of 0–1000 m, follow normal operation restrictions. If it is installed at an altitude of 1000–2000 m, decrease the rated current by 1% or lower the temperature 0.5°C for every 100 m increase in altitude. The maximum altitude for corner grounded is 2000 m. Contact Delta for more information if you need to use this motor drive at an altitude of 2000 m or higher.

Chapter 10 Digital Keypad

Keyboard panel

Main Display Area

Displays Frequency, Current, Voltage, User-defined Units, Errors and more

Status Display Area

Displays the operation status of the drive: Run, Stop, Forward, Reverse

Up Key

Changes the setting value and the parameters

Run Key

Starts the drive

Stop / Reset Key

Stops the drive and resets after error



Potentiometer

Adjusts the input frequency

Selection Key for Display Screen

Changes the Display Screen mode

Enter Key

1. Enters the setting page, such as Forward command (Frd), Application selection function (APP)
2. Confirms the setting of the parameter

Left Shift / Down Key

Changes the setting value and parameters (Switch between Left Shift and Down by long pressing the Mode Key)

Descriptions of keypad functions

Displayed items	Descriptions
RUN ● FWD ● REV ● ● STO ● PLC	Displays the present frequency setting for the drive.
RUN ● FWD ● REV ● ● STO ● PLC	Displays the actual frequency output to the motor.
RUN ● FWD ● REV ● ● STO ● PLC	Displays the user-defined output of a physical quantity. This example is for parameter Pr.00-04 = 30.
RUN ● FWD ● REV ● ● STO ● PLC	Displays the load current.
RUN ● FWD ● REV ● ● STO ● PLC	Forward command
RUN ● FWD ● REV ● ● STO ● PLC	Reverse command
RUN ● FWD ● REV ● ● STO ● PLC	Displays the count value.
RUN ● FWD ● REV ● ● STO ● PLC	Displays a parameter item.
RUN ● FWD ● REV ● ● STO ● PLC	Displays the content of a parameter value.
RUN ● FWD ● REV ● ● STO ● PLC	Displays an external fault.
RUN ● FWD ● REV ● ● STO ● PLC	Displays the data that has been accepted and automatically stored in the internal memory.
RUN ● FWD ● REV ● ● STO ● PLC	Displays the data set that is not accepted or has exceeded the value.

Keypad operation process

A. Main Page Selection



Note 1: In screen selection mode, press to set parameter
 Note 2: "APP" displayed only when Pr.13-00≠0

Setting parameters



Note: In the parameter setting mode, you can press to return to the selection mode.

To shift data



Setting direction (When the operation source is the digital keypad.)

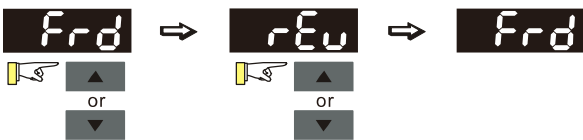

B. F Page (Frequency command setting page)

General Mode 1

(maximum operation frequency Pr.01-00 is 2 digits; for example Pr.01-00 = 60.00 Hz)



General Mode 2

(maximum operation frequency Pr.01-00 is 3 digits; for example Pr.01-00 = 599.0 Hz)

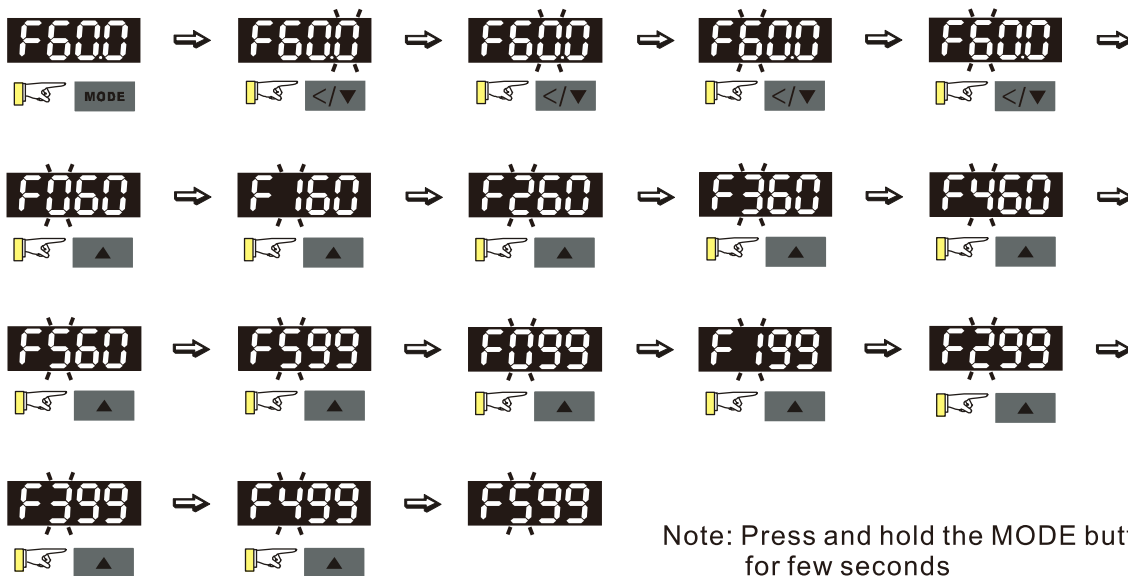

C. Application Selection Page

The Application Selection page displays “APP”, but does not show the APP page when Pr.13-00 = 0. The description of Pr.13-00 setting is as follows:

Pr.13-00 = 0

The application selection is inactive and does not show on the display.



Pr.13-00 = 1 specifies a user-defined application, and the keypad displays “USER”.

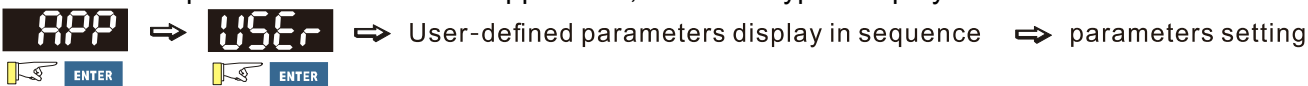

Pr.13-00 = 3 specifies the Fan application, and the keypad displays “FAN”.

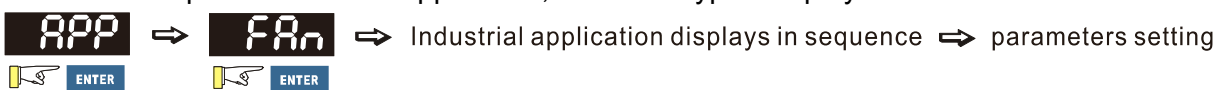

Pr.13-00 = 4 specifies the Pump application, and the keypad displays “PUMP”.

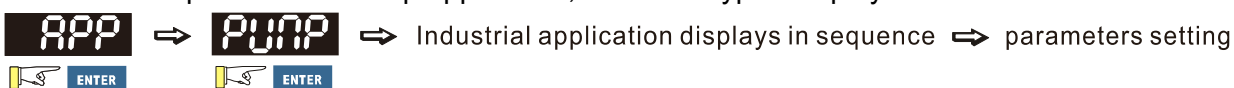

Pr.13-00 = 5 specifies the Conveyor application, and the keypad displays “CnYr”.

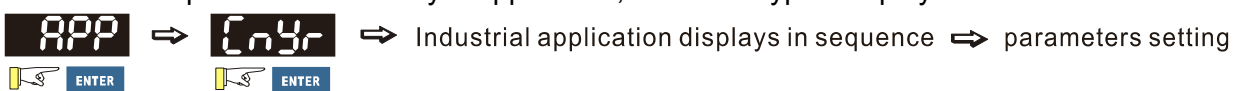

Pr.13-00 = 7 specifies the Packing application, and the keypad displays “PACK”.

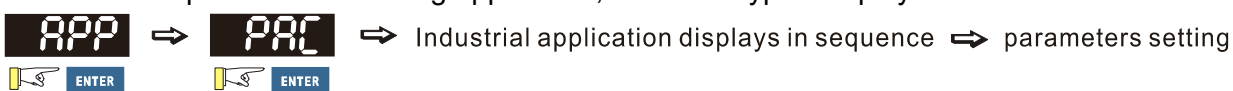

When Pr.13-00 is not 0, the corresponding parameters appear in the APP page according to the setting for Pr.13-00. In each selected application, you can view the parameters by pressing the digital dial button. If Pr.13-00 = 1 and you do not set any parameters in Pr.13-01–Pr.13-50, you cannot enter the sub-layer of the USER page. The parameter settings in the APP page are the same as those in other parameter groups: rotate and then press the digital dial to select and set the parameter’s value.

Follow the process below to set the user-defined application selection (Pr.13-00 = 1).

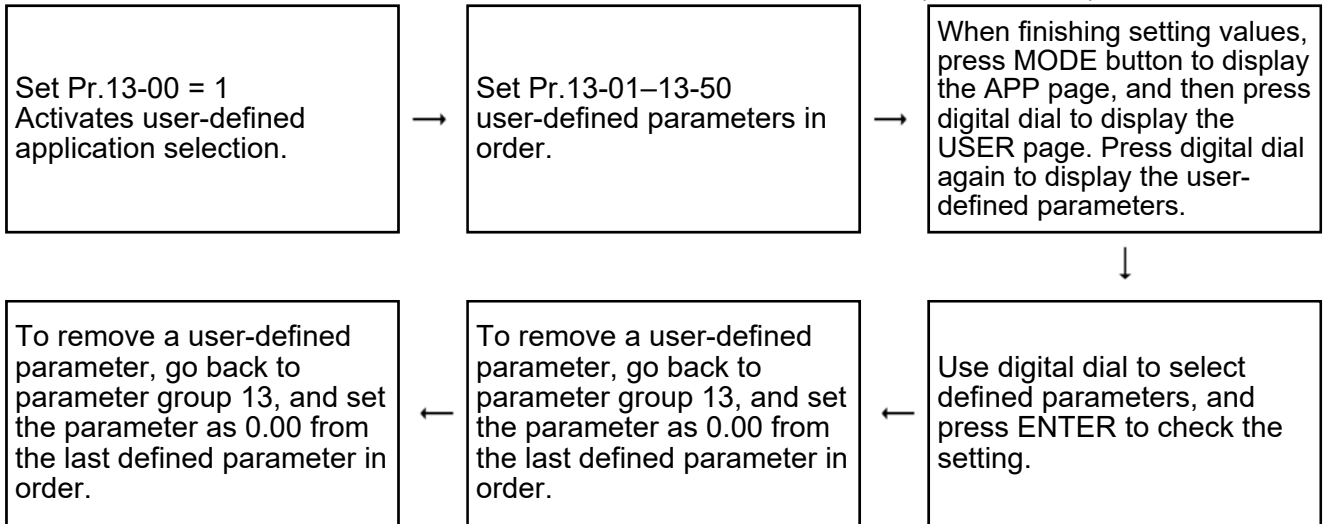

1. Activate the application selection by setting Pr.13-00.
2. After setting Pr.13-00 = 1, you can enter the definitions for Pr.13-01–50.
3. The default setting for Pr.13-01–50 is P 0.00. Press the digital dial to set the corresponding parameters for Pr.13-01–50 in sequence.
4. Setting the corresponding parameters for Pr.13-01–50 is the same as those in other parameter groups: rotate and press the digital dial to select and set the parameter’s value.

Note 1: you cannot set values for read-only parameters.

Note 2: you must set Pr.13-01, 02...50 in sequence, or the display shows “Err”.

5. To change the corresponding parameters, go back to Pr.13-01–13-50 to modify.
6. After setting, to remove a set parameter, set from the last parameter (set to 0.00) first, or the display shows “Err”.

For example, if there are 5 user-defined parameters (Pr.13-01, 13-02...13-05), to remove Pr.13-02, you must remove Pr.13-05 first, then 13-04, then 13-03, and then 13-02.

7. When you finish setting, press MODE to go back to the APP page, and then press the digital dial again. The keypad displays “USER”. After you press the digital dial again, the corresponding parameter that you set appears.

Follow the process below to set specific application selection (Pr.13-00 = 2, 3, 4, 5, or 7).

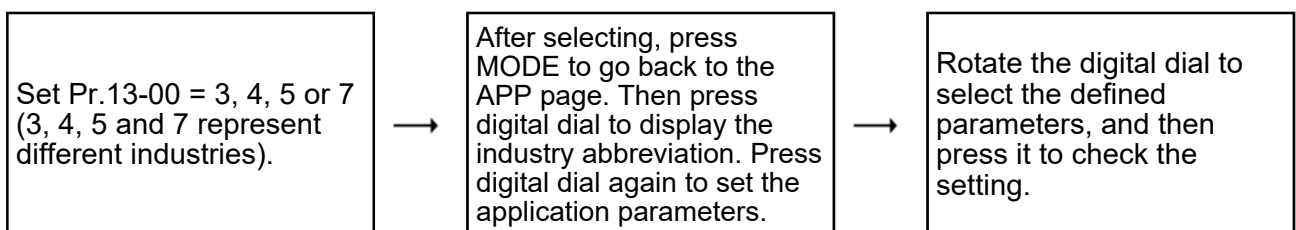

D. Parameter setting

D-1. Unsigned parameter

(Parameter setting range ≥ 0 ; for example: Pr.01-00)

- Without using the left shift key: rotate the digital dial to select and adjust the parameters.
- Using the left shift key: After you press the left shift key, the last digit starts to blink. Press the left shift key to move the blinking cursor to the digit to adjust, and increase the value by rotating the digital dial clockwise. The value goes back to 0 after 9. Decrease the value by rotating the digital dial counter-clockwise. The value goes to 9 after 0.

For example: the default setting for Pr.01-00 is 60.0. Pressing the left shift key causes the blinking cursor to move one digit to the left:



The upper limit for Pr.01-00 is 599.0. If you set a value greater than 599.0, “Err” appears after you press the digital dial, and then the keypad shows the upper limit (599.0) for a second to remind you of the incorrect setting. The setting value remains as the original set value and the cursor returns to the last digit.

D-2. Signed parameter setting status 1

(Parameter setting range has no or 1 decimal place, the range can be smaller than 0; for example: Pr.03-03)

- Without using the left shift key: rotate the digital dial to select and adjust the parameters.
- Using the left shift key: After pressing the left shift key, the last digit starts to blink. Press the left shift key to move the blinking cursor to the digit to adjust, and increase the value by rotating the digital dial clockwise. The value goes back to 0 after 9. Decrease the value by rotating the digital dial counter-clockwise, and the value goes to 9 after 0.
- Press the left shift key to shift the blinking cursor one digit to the left. When you shift to the first digit and press the digital dial, the digit “0” changes to “-” (minus).
- As for parameters’ settings of 3-digit and one decimal place (Pr.03-03, -100–100%), it only displays 3 digits on the keypad.

For example: the default setting for Pr.03-03 is 0.0. If the value should be -100, then use the left shift key to shift the blinking cursor to the hundreds digit. Rotate the digital dial clockwise to 1, and then press the left shift key to move to the first digit. Rotate the digital dial from “0” to “-”.

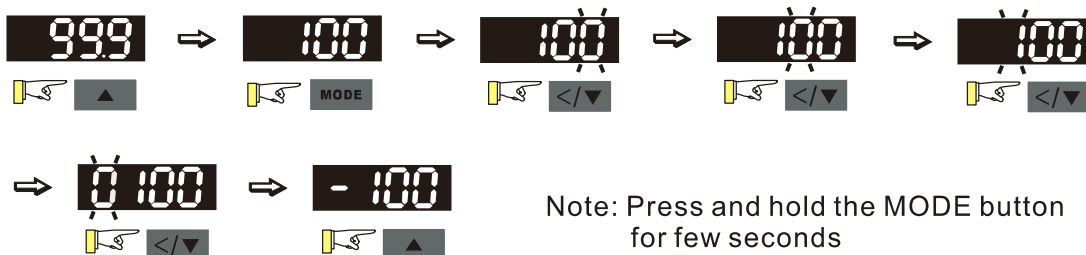

The upper limit for Pr.03-03 is 100.0 and lower limit is -100.0. If the value is more than 100.0 or less than -100.0, “Err” appears after you press the digital dial, and then the keypad shows the

upper limit (100.0) or lower limit (-100.0) for a second to remind you of the incorrect setting. The setting value remains as the original set value, and the cursor returns to the last digit.

Reference Table for the 16-segment Digital Keypad LED Display

Number	0	1	2	3	4	5	6	7	8	9
Eleven-Segment Display										
Number	A	a	B	b	C	c	D	d	E	e
Eleven-Segment Display		-	-				-			-
Number	F	f	G	g	H	h	I	i	J	j
Eleven-Segment Display		-		-			-			
Number	K	k	L	l	M	m	N	n	O	o
Eleven-Segment Display		-		-	-	-	-		-	
Number	P	p	Q	q	R	r	S	s	T	t
Eleven-Segment Display		-	-		-			-	-	
Number	U	u	V	v	W	w	X	x	Y	y
Eleven-Segment Display			-		-	-	-	-		-
Number	Z	z								
Eleven-Segment Display		-								

Chapter 11 Summary of Parameter Settings

This chapter provides a summary of parameter (Pr.) setting ranges and defaults. You can set, change, and reset parameters through the digital keypad.



↗: You can set this parameter during operation

00 Drive Parameters

Pr.	Explanation	Settings	Default
00-00	Identity code of the AC motor drive	101: 115 V, 1 Phase, 0.125 HP	Read only
		102: 115 V, 1 Phase, 0.25 HP	
		103: 115 V, 1 Phase, 0.5 HP	
		104: 115 V, 1 Phase, 1 HP	
		301: 230 V, 1 Phase, 0.125 HP	
		302: 230 V, 1 Phase, 0.25 HP	
		303: 230 V, 1 Phase, 0.5 HP	
		304: 230 V, 1 Phase, 1 HP	
		305: 230 V, 1 Phase, 2 HP	
		306: 230 V, 1 Phase, 3 HP	
		201: 230 V, 3 Phase, 0.125 HP	
		202: 230 V, 3 Phase, 0.25 HP	
		203: 230 V, 3 Phase, 0.5 HP	
		204: 230 V, 3 Phase, 1 HP	
		205: 230 V, 3 Phase, 2 HP	
		206: 230 V, 3 Phase, 3 HP	
		207: 230 V, 3 Phase, 5 HP	
		208: 230 V, 3 Phase, 7.5 HP	
		209: 230 V, 3 Phase, 10 HP	
		210: 230 V, 3 Phase, 15 HP	
		211: 230 V, 3 Phase, 20 HP	
		403: 460 V, 3 Phase, 0.5 HP	
		404: 460 V, 3 Phase, 1 HP	
		405: 460 V, 3 Phase, 2 HP	
406: 460 V, 3 Phase, 3 HP			
407: 460 V, 3 Phase, 5 HP			
408: 460 V, 3 Phase, 7.5 HP			
409: 460 V, 3 Phase, 10 HP			
410: 460 V, 3 Phase, 15 HP			
411: 460 V, 3 Phase, 20 HP			
412: 460 V, 3 Phase, 25 HP			
413: 460 V, 3 Phase, 30 HP			

Pr.	Explanation	Settings	Default
00-01	Display AC motor drive rated current	Display by model	Read only
00-02	Parameter reset	0: No function 1: Parameter write protect 5: Reset KWH display to 0 8: Keypad does not respond 9: Reset all parameters to defaults with base frequency at 50 Hz 10: Reset all parameters to defaults with base frequency at 60 Hz 11: Reset all parameters to defaults with base frequency at 50 Hz (keep the user-defined parameter values Pr.13-01–13-50) 12: Reset all parameters to defaults with base frequency at 60 Hz (keep the user-defined parameter values Pr.13-01–13-50)	0
↗ 00-03	Select start-up display	0: F (frequency command) 1: H (output frequency) 2: U (user-defined, refer to Pr.00-04) 3: A (output current)	0
↗ 00-04	Content of Multi-function display (user-defined)	0: Output current (A) (unit: Amps) 1: Counter value (c) (unit: CNT) 2: Actual output frequency (H.) (unit: Hz) 3: DC BUS voltage (V) (unit: V _{DC}) 4: Output voltage (E) (unit: V _{AC}) 5: Output power angle (n) (unit: deg) 6: Output power in kW (P) (unit: kW) 7: Motor speed (unit: rpm) 10: PID feedback (b) (unit: %) 11: Signal value of AVI analog input terminal (1.) (unit: %) 12: Signal value of ACI analog input terminal (2.) (unit: %) 14: Temperature of IGBT (i.) (unit: °C) 16: Display digital input status ON/OFF (i) 17: Digital output status ON/OFF (o) 18: Multi-step execution speed (S) 19: Digital input CPU pin status (d) 20: Digital output CPU pin status (0.) 25: Overload count (0.00–100.00%) (o.) (unit: %)	3

Pr.	Explanation	Settings	Default
		26: GFF ground fault (G.) (unit: %) 27: DC BUS voltage ripple (r.) (unit: V_{DC}) 30: Output user-defined parameter (U) 31: H page x 00-05 user gain (K) 35: Control mode: 0 = Speed control mode (SPD) 36: Current operating carrier frequency (J.) (Unit: Hz) 38: Drive status (6.) 41: KWH (J) (unit: kWh) 42: PID target value (h.) (unit: %) 43: PID offset (o.) (unit: %) 44: PID output frequency (b.) (unit: Hz) 47: Master frequency value (A) (unit: Hz) 61: Display the content of the running program (1=tt)	
↗	00-05	Coefficient gain in actual output frequency 0.00–160.00	1.00
	00-06	Firmware version Read only	##
↗	00-07	Parameter protection password input 0–65535 0–3 (the number of password attempts allowed)	0
↗	00-08	Parameter protection password setting 0: No password protection / password entered incorrectly (Pr.00-07) 1: Password set	0
	00-10	Control mode 0: Speed mode	0
	00-11	Speed Control mode 0: VF (IM V/F control) 2: SVC (Pr.05-33 set as IM or PM)	0
	00-16	Load selection 0: Normal load 1: Heavy load	1
	00-17	Carrier frequency Normal load: 2–15 kHz Heavy load: 2–15 kHz	4
			4
↗	00-20	Master frequency command (AUTO) source 0: Digital keypad 1: RS-485 communication 2: External analog input (refer to Pr.03-00) 3: External UP/DOWN terminal 4: Pulse input without direction command (refer to Pr.10-16 without direction) 7: Digital keypad dial	0
↗	00-21	Operation command (AUTO) source 0: Digital keypad 1: External terminals 2: RS-485 communication input	0

Pr.	Explanation	Settings	Default
↗ 00-22	Stop method	0: Ramp to stop 1: Coast to stop 2: Motor stops by simple positioning	0
↗ 00-23	Control of motor direction	0: Enable forward and reverse 1: Disable reverse 2: Disable forward	0
00-24	Digital keypad frequency command memory	Read only	Read only
↗ 00-25	User-defined characteristics	bit 0–3: user-defined decimal places 0000b: no decimal place 0001b: one decimal place 0010b: two decimal places 0011b: three decimal places bit 4–15: user-defined unit 000xh: Hz 001xh: rpm 002xh: % 003xh: kg 004xh: m/s 005xh: kW 006xh: HP 007xh: ppm 008xh: l/m 009xh: kg/s 00Axh: kg/m 00Bxh: kg/h 00Cxh: lb/s 00Dxh: lb/m 00Exh: lb/h 00Fxh: ft/s 010xh: ft/m 011xh: M 012xh: ft 013xh: degC 014xh: degF 015xh: mbar 016xh: bar 017xh: Pa 018xh: kPa 019xh: mWG	0

Pr.	Explanation	Settings	Default
		01Axx: inWG 01Bxx: ftWG 01Cxx: Psi 01Dxx: Atm 01Exx: L/s 01Fxx: L/m 020xx: L/h 021xx: m ³ /s 022xx: m ³ /h 023xx: GPM 024xx: CFM	
00-26	Maximum user-defined value	0: Disable 0–65535 (when Pr.00-25 set to no decimal place) 0.0–6553.5 (when Pr.00-25 set to 1 decimal place) 0.0–655.35 (when Pr.00-25 set to 2 decimal places) 0.0–65.535 (when Pr.00-25 set to 3 decimal places)	0
00-27	User-defined value	Read only	Read only
00-29	LOCAL/REMOTE mode	0: Standard HOA function 1: When switching between local and remote, the drive stops. 2: When switching between local and remote, the drive runs with REMOTE settings for frequency and operation status. 3: When switching between local and remote, the drive runs with LOCAL settings for frequency and operation status. 4: When switching between local and remote, the drive runs with LOCAL settings when switched to Local and runs with REMOTE settings when switched to Remote for frequency and operation status.	0
⚡ 00-30	Master frequency command (HAND) source	0: Digital keypad 1: RS-485 communication 2: External analog input (refer to Pr.03-00) 3: External UP/DOWN terminal 7: Digital keypad dial	0
⚡ 00-31	Operation command (HAND) source	0: Digital keypad 1: External terminals 2: RS-485 communication	0
⚡ 00-32	Digital keypad STOP function	0: Disable STOP key 1: Enable STOP key	0

	Pr.	Explanation	Settings	Default
↗	00-48	Display filter time (current)	0.001–65.535 sec.	0.100
↗	00-49	Display filter time (keypad)	0.001–65.535 sec.	0.100
	00-50	Software version (date)	Read only	#####

01 Basic Parameters

Pr.	Explanation	Settings	Default
01-00	Maximum operation frequency of motor 1	0.00–599.00 Hz	60.00/ 50.00
01-01	Output frequency of motor 1	0.00–599.00 Hz	60.00/ 50.00
01-02	Output voltage of motor 1	115V / 230V series: 0.0–255.0 V 460V series: 0.0–510.0 V	220.0 440.0
01-03	Mid-point frequency 1 of motor 1	0.00–599.00 Hz	3.00
✎ 01-04	Mid-point voltage 1 of motor 1	115V / 230V series: 0.0–240.0 V 460V series: 0.0–480.0 V	11.0 22.0
01-05	Mid-point frequency 2 of motor 1	0.00–599.00 Hz	1.5
✎ 01-06	Mid-point voltage 2 of motor 1	115V / 230V series: 0.0–240.0 V 460V series: 0.0–480.0 V	5.0 10.0
01-07	Minimum output frequency of motor 1	0.00–599.00 Hz	0.50
✎ 01-08	Minimum output voltage of motor 1	115V / 230V series: 0.0–240.0 V 460V series: 0.0–480.0 V	1.0 2.0
01-09	Start-up frequency	0.00–599.00 Hz	0.50
✎ 01-10	Output frequency upper limit	0.00–599.00 Hz	599.00
✎ 01-11	Output frequency lower limit	0.00–599.00 Hz	0.00
✎ 01-12	Acceleration time 1	Pr.01-45 = 0: 0.00–600.00 sec. Pr.01-45 = 1: 0.0–6000.0 sec.	10.00 10.0
✎ 01-13	Deceleration time 1	Pr.01-45 = 0: 0.00–600.00 sec. Pr.01-45 = 1: 0.0–6000.0 sec.	10.00 10.0
✎ 01-14	Acceleration time 2	Pr.01-45 = 0: 0.00–600.00 sec. Pr.01-45 = 1: 0.0–6000.0 sec.	10.00 10.0
✎ 01-15	Deceleration time 2	Pr.01-45 = 0: 0.00–600.00 sec. Pr.01-45 = 1: 0.0–6000.0 sec.	10.00 10.0
✎ 01-16	Acceleration time 3	Pr.01-45 = 0: 0.00–600.00 sec. Pr.01-45 = 1: 0.0–6000.0 sec.	10.00 10.0
✎ 01-17	Deceleration time 3	Pr.01-45 = 0: 0.00–600.00 sec. Pr.01-45 = 1: 0.0–6000.0 sec.	10.00 10.0
✎ 01-18	Acceleration time 4	Pr.01-45 = 0: 0.00–600.00 sec. Pr.01-45 = 1: 0.0–6000.0 sec.	10.00 10.0
✎ 01-19	Deceleration time 4	Pr.01-45 = 0: 0.00–600.00 sec. Pr.01-45 = 1: 0.0–6000.0 sec.	10.00 10.0
✎ 01-20	JOG acceleration time	Pr.01-45 = 0: 0.00–600.00 sec. Pr.01-45 = 1: 0.0–6000.0 sec.	10.00 10.0

	Pr.	Explanation	Settings	Default
↗	01-21	JOG deceleration time	Pr.01-45 = 0: 0.00–600.00 sec. Pr.01-45 = 1: 0.0–6000.0 sec.	10.00 10.0
↗	01-22	JOG frequency	0.00–599.00 Hz	6.00
↗	01-23	First/Fourth acceleration / deceleration frequency	0.00–599.00 Hz	0.00
↗	01-24	S-curve acceleration begin time 1	Pr.01-45 = 0: 0.00–25.00 sec. Pr.01-45 = 1: 0.0–250.0 sec.	0.20 0.2
↗	01-25	S-curve acceleration arrival time 2	Pr.01-45 = 0: 0.00–25.00 sec. Pr.01-45 = 1: 0.0–250.0 sec.	0.20 0.2
↗	01-26	S-curve deceleration begin time 1	Pr.01-45 = 0: 0.00–25.00 sec. Pr.01-45 = 1: 0.0–250.0 sec.	0.20 0.2
↗	01-27	S-curve deceleration arrival time 2	Pr.01-45 = 0: 0.00–25.00 sec. Pr.01-45 = 1: 0.0–250.0 sec.	0.20 0.2
	01-28	Skip frequency 1 (upper limit)	0.00–599.00 Hz	0.00
	01-29	Skip frequency 1 (lower limit)	0.00–599.00 Hz	0.00
	01-30	Skip frequency 2 (upper limit)	0.00–599.00 Hz	0.00
	01-31	Skip frequency 2 (lower limit)	0.00–599.00 Hz	0.00
	01-32	Skip frequency 3 (upper limit)	0.00–599.00 Hz	0.00
	01-33	Skip frequency 3 (lower limit)	0.00–599.00 Hz	0.00
	01-34	Zero-speed mode	0: Waiting for output 1: Zero-speed operation 2: Minimum frequency (refer to Pr.01-07 and Pr.01-41)	0
	01-35	Output frequency of motor 2	0.00–599.00 Hz	60.00/ 50.00
	01-36	Output voltage of motor 2	115 / 230 V series: 0.0–255.0 V 460 V series: 0.0–510.0 V	220.0 440.0
	01-37	Mid-point frequency 1 of motor 2	0.00–599.00 Hz	3.00
↗	01-38	Mid-point voltage 1 of motor 2	115 / 230 V series: 0.0–240.0 V 460 V series: 0.0–480.0 V	11.0 22.0
	01-39	Mid-point frequency 2 of motor 2	0.00–599.00 Hz	0.50
↗	01-40	Mid-point voltage 2 of motor 2	115 / 230 V series: 0.0–240.0 V 460 V series: 0.0–480.0 V	2.0 4.0
	01-41	Minimum output frequency of motor 2	0.00–599.00 Hz	0.00
↗	01-42	Minimum output voltage of motor 2	115 / 230 V series: 0.0–240.0 V 460 V series: 0.0–480.0 V	0.0 0.0
	01-43	V/F curve selection	0: V/F curve determined by Pr.01-00–01-08 1: 1.5 th V/F curve 2: 2 nd V/F curve	0

Pr.	Explanation	Settings	Default
01-44	Auto-acceleration and auto-deceleration setting	0: Linear acceleration and linear deceleration 1: Auto-acceleration and linear deceleration 2: Linear acceleration and auto-deceleration 3: Auto-acceleration and auto-deceleration 4: Stall prevention by auto-acceleration and auto-deceleration (limited by Pr.01-12-01-21)	0
01-45	Time unit for acceleration and deceleration and S-curve	0: Unit 0.01 sec. 1: Unit 0.1 sec.	0
01-49	Deceleration method	0: Normal deceleration 1: Overfluxing deceleration 2: Traction energy control	0
01-52	Maximum operation frequency of motor 2	0.00–599.00 Hz	60.00/ 50.00

02 Digital Input / Output Parameters

Pr.	Explanation	Settings	Default
02-00	Two-wire / Three-wire operation control	0: No function 1: Two-wire mode 1, power on for operation control (M1: FWD/STOP, M2: REV/STOP) 2: Two-wire mode 2, power on for operation control (M1: RUN/STOP, M2: FWD/REV) 3: Three-wire, power on for operation control (M1: RUN, M2: REV/FWD, M3: STOP) 4: Two-wire mode 1, Quick Start (M1: FWD/STOP, M2: REV/STOP) 5: Two-wire mode 2, Quick Start (M1: RUN/STOP, M2: FWD/REV) 6: Three-wire, Quick Start (M1: RUN, M2: REV/FWD, M3: STOP) <u>IMPORTANT</u> 1. In the Quick Start mode, terminal output stays in a ready state, and the drive responds to the command immediately. 2. When using the Quick Start function, the output terminal has higher potential voltage.	1
02-01	Multi-function input command 1 (M11)	0: No function	0
02-02	Multi-function input command 2 (M12)	1: Multi-step speed command 1 / multi-step position command 1 2: Multi-step speed command 2 / multi-step position command 2	0
02-03	Multi-function input command 3 (M13)	3: Multi-step speed command 3 / multi-step position command 3	1
02-04	Multi-function input command 4 (M14)	4: Multi-step speed command 4 / multi-step position command 4	2
02-05	Multi-function input command 5 (M15)	5: Reset	3
		6: JOG operation 7: Acceleration / deceleration speed inhibit 8: 1 st and 2 nd acceleration / deceleration time selection 9: 3 rd and 4 th acceleration / deceleration time Selection 10: EF Input (Pr.07-20) 11: Base Block (B.B.) input from external	

Pr.	Explanation	Settings	Default
		12: Output stop 13: Cancel the setting for auto-acceleration / auto-deceleration time 15: Rotating speed command from AVI 18: Forced to stop (Pr.07-20) 19: Digital up command 20: Digital down command 21: PID function disabled 22: Clear the counter 23: Input the counter value (MI6) 24: FWD JOG command 25: REV JOG command 28: Emergency stop (EF1) 29: Signal confirmation for Y-connection 30: Signal confirmation for Δ -connection 38: Disable write EEPROM function 40: Force coasting to stop 41: HAND switch 42: AUTO switch 49: Enable Drive 50: Master dEb input 56: Local/Remote selection 69: Auto-activate preheating function 71: Disable PID function, force PID output return to 0 72: Disable PID function, retain the output value before disabled 73: Force PID integral gain return to 0, disable integral 74: Reverse PID feedback 83: Multi-motors (IM) selection bit 0 94: Programmable AUTO RUN 95: Pausing AUTO RUN 98: Simple positioning stop by forward limit 99: Simple positioning stop by reverse limit	
↗ 02-09	UP/DOWN key mode	0: UP/DOWN by acceleration / deceleration time 1: UP/DOWN constant speed (Pr.02-10) 2: Pulse command (Pr.02-10) 3: External terminals UP/DOWN mode	0

Pr.	Explanation	Settings	Default
02-10	Constant speed; acceleration / deceleration speed of UP/DOWN key	0.001–1.000 Hz/ms	0.001
02-11	Multi-function input response time	0.000–30.000 sec.	0.005
02-12	Multi-function input mode selection	0000h–FFFFh (0: N.O.; 1: N.C.)	0000
02-13	Multi-function output 1 RY1	0: No function	11
02-16	Multi-function output 2 (MO1)	1: Indication during RUN	0
		2: Operation speed reached	
		3: Desired frequency reached 1 (Pr.02-22)	
		4: Desired frequency reached 2 (Pr.02-24)	
		5: Zero speed (Frequency command)	
		6: Zero speed including STOP (Frequency command)	
		7: Over-torque 1 (Pr.06-06–06-08)	
		8: Over-torque 2 (Pr.06-09–06-11)	
		9: Drive is ready	
		10: Low voltage warning (LV) (Pr.06-00)	
		11: Malfunction indication	
		13: Over-heat warning (Pr.06-15)	
		14: Software brake signal indication (Pr.07-00)	
		15: PID feedback error	
		16: Slip error (oSL)	
		17: Count value reached; does not return to 0 (Pr.02-20)	
		18: Count value reached; returns to 0 (Pr.02-19)	
		19: External interrupt B.B. input (Base Block)	
		20: Warning output	
		21: Over-voltage	
		22: Over-current stall prevention	
		23: Over-voltage stall prevention	
		24: Operation source	
		25: Forward command	
		26: Reverse command	
		29: Output when frequency \geq Pr.02-34	
		30: Output when frequency $<$ Pr.02-34	
		31: Y-connection for the motor coil	
		32: Δ -connection for the motor coil	
		33: Zero speed (actual output frequency)	

Pr.	Explanation	Settings	Default	
		34: Zero speed including STOP (actual output frequency) 35: Error output selection 1 (Pr.06-23) 36: Error output selection 2 (Pr.06-24) 37: Error output selection 3 (Pr.06-25) 38: Error output selection 4 (Pr.06-26) 40: Speed reached (including STOP) 42: Crane function 43: Motor speed slower than Pr.02-47 44: Low current output (use with Pr.06-71–06-73) 45: UVW output electromagnetic valve switch 46: Master dEb output 51: Output control for RS-485 66: SO output logic A (use with STO Card) 67: Analog input level reached 68: SO output logic B (use with STO Card) 69: Indication of Preheating 73: Over-torque 3 74: Over-torque 4 75: Forward RUN status 76: Reverse RUN status 77: Program Running Indication 78: Program Step Completed Indication 79: Program Running Completed Indication 80: Program Running Paused Indication		
↗	02-18	Multi-function output direction	0000h–FFFFh (0: N.O.; 1: N.C.)	0000
↗	02-19	Terminal counting value reached (returns to 0)	0–65500	0
↗	02-20	Preliminary counting value reached (does not return to 0)	0–65500	0
↗	02-22	Desired frequency reached 1	0.00–599.00 Hz	60.00/ 50.00
↗	02-23	Width of desired frequency reached 1	0.00–599.00 Hz	2.00
↗	02-24	Desired frequency reached 2	0.00–599.00 Hz	60.00/ 50.00
↗	02-25	Width of desired frequency reached 2	0.00–599.00 Hz	2.00
↗	02-34	Output frequency setting for multi-function output terminal	0.00–599.00 Hz	0.00

Pr.	Explanation	Settings	Default
✎ 02-35	External operation control selection after reset and activate	0: Disable 1: Drive runs if the RUN command remains after reset or reboot.	0
✎ 02-47	Motor zero-speed level	0–65535 rpm	0
02-50	Display the status of multi-function input terminal	Monitor the status of multi-function input terminals	Read only
02-51	Display the status of multi-function output terminal	Monitor the status of multi-function output terminals	Read only
02-54	Display the Frequency command executed by external terminal	Read only	Read only
02-58	Multi-function output terminal (function 42): brake frequency check point	0.00–599.00 Hz	0.00
✎ 02-72	Level of Preheating DC Current	0–100%	0
✎ 02-73	Preheating DC Current Duty Cycle	0–100%	0
✎ 02-81	EF active when terminal count value reached	0: Terminal count value reached, no EF displays 1: Terminal count value reached, EF is active	0
✎ 02-82	Initial Frequency command (F) mode after stop	0: Use current Frequency command 1: Use zero Frequency command 2: Refer to Pr.02-83 to setup	0
✎ 02-83	Initial Frequency command (F) setting after stop	0.00–599.0 Hz	60.00

03 Analog Input / Output Parameters

Pr.	Explanation	Settings	Default
↗ 03-00	Analog input selection (AVI)	0: No function 1: Frequency command 4: PID target value 5: PID feedback signal 6: PTC thermistor input value 11: PT100 thermistor input value 13: PID compensation value	1
↗ 03-03	Analog input bias (AVI)	-100.0–100.0%	0.0
↗ 03-04	Analog input bias (ACI)	-100.0–100.0%	0.0
↗ 03-07	Positive / negative bias mode (AVI)	0: No bias 1: Lower than or equal to bias 2: Greater than or equal to bias	0
↗ 03-08	Positive / negative bias mode (ACI)	3: The absolute value of the bias voltage while serving as the center 4: Bias serves as the center	
↗ 03-10	Reverse setting when analog signal input is negative frequency	0: Negative frequency input is not allowed. The digital keypad or external terminal controls the forward and reverse direction. 1: Negative frequency input is allowed. Positive frequency = run in forward direction; negative frequency = run in reverse direction. The digital keypad or external terminal control cannot switch the running direction.	0
↗ 03-11	Analog input gain (AVI)	-500.0–500.0%	100.0
↗ 03-12	Analog input gain (ACI)	-500.0–500.0%	100.0
↗ 03-15	Analog input filter time (AVI)	0.00–20.00 sec.	0.01
↗ 03-16	Analog input filter time (ACI)	0.00–20.00 sec.	0.01
↗ 03-19	Signal loss selection for analog input 4–20 mA	0: Disable 1: Continue operation at the last frequency 2: Decelerate to 0 Hz 3: Stop immediately and display “ACE”	0
↗ 03-20	Multi-function output (AFM)	0: Output frequency (Hz) 1: Frequency command (Hz) 2: Motor speed (Hz) 3: Output current (rms) 4: Output voltage 5: DC BUS voltage	0

Pr.	Explanation	Settings	Default
		6: Power factor 7: Power 9: AVI 12: Iq current command 13: Iq feedback value 14: Id current command 15: Id feedback value 16: Vq-axis voltage command 17: Vd-axis voltage command 21: RS-485 analog output 23: Constant voltage output	
✎ 03-21	Analog output gain (AFM)	0.0–500.0%	100.0
✎ 03-22	Analog output in REV direction (AFM)	0: Absolute value of output voltage 1: Reverse output 0 V; forward output 0–10 V 2: Reverse output 5–0 V; forward output 5–10 V	0
✎ 03-27	AFM output bias	-100.00–100.00%	0.00
✎ 03-28	AVI terminal input selection	0: 0–10 V 1: 0-20 mA (Pr.03-57–03-62 is valid) 2: 4-20 mA (Pr.03-57–03-62 is valid)	0
✎ 03-32	AFM DC output setting level	0.00–100.00%	0.00
✎ 03-35	AFM filter output time	0.00–20.00 sec.	0.01
✎ 03-39	VR input selection	0: Disable 1: Frequency command	1
✎ 03-40	VR Input Bias	-100.0–100.0%	0.0
✎ 03-41	VR Positive / Negative Bias	0: No bias 1: Lower than or equal to bias 2: Greater than or equal to bias 3: The absolute value of the bias voltage while serving as the center 4: Bias serves as the center	0
✎ 03-42	VR Gain	-500.0–500.0%	100.0
✎ 03-43	VR Filter Time	0–2.00 sec.	0.01
✎ 03-44	Multi-function MO output by AI level source	0: AVI 1: ACI	0
✎ 03-45	AI upper level 1	-100.00–100.00%	50.00
✎ 03-46	AI lower level 2	-100.00–100.00%	10.00
✎ 03-50	Analog input curve selection	0: Regular curve 1: Three-point curve of AVI (& AI10) 2: Three-point curve of ACI (& AI11)	0

	Pr.	Explanation	Settings	Default
↗	03-57	ACI lowest point	Pr.03-28 ≠ 1, 0.00–20.00 mA	4.00
↗	03-58	ACI proportional lowest point	0.00–100.00%	0.00
↗	03-59	ACI mid-point	Pr.03-2 ≠ 1, 0.00–20.00 mA	12.00
↗	03-60	ACI proportional mid-point	0.00–100.00%	50.00
↗	03-61	ACI highest point	Pr.03-28 ≠ 1, 0.00–20.00 mA	20.00
↗	03-62	ACI proportional highest point	0.00–100.00%	100.00
↗	03-63	AVI voltage lowest point	0.00–10.00 V	0.00
↗	03-64	AVI voltage proportional lowest point	-100.00–100.00%	0.00
↗	03-65	AVI voltage mid-point	0.00–10.00 V	5.00
↗	03-66	AVI voltage proportional mid-point	-100.00–100.00%	50.00
↗	03-67	AVI voltage highest point	0.00–10.00 V	10.00
↗	03-68	AVI voltage proportional highest point	-100.00–100.00%	100.00

04 Multi-step Speed Parameters

	Pr.	Explanation	Settings	Default
↗	04-00	1 st step speed frequency	0.00–599.00 Hz	0.00
↗	04-01	2 nd step speed frequency	0.00–599.00 Hz	0.00
↗	04-02	3 rd step speed frequency	0.00–599.00 Hz	0.00
↗	04-03	4 th step speed frequency	0.00–599.00 Hz	0.00
↗	04-04	5 th step speed frequency	0.00–599.00 Hz	0.00
↗	04-05	6 th step speed frequency	0.00–599.00 Hz	0.00
↗	04-06	7 th step speed frequency	0.00–599.00 Hz	0.00
↗	04-07	8 th step speed frequency	0.00–599.00 Hz	0.00
↗	04-08	9 th step speed frequency	0.00–599.00 Hz	0.00
↗	04-09	10 th step speed frequency	0.00–599.00 Hz	0.00
↗	04-10	11 th step speed frequency	0.00–599.00 Hz	0.00
↗	04-11	12 th step speed frequency	0.00–599.00 Hz	0.00
↗	04-12	13 th step speed frequency	0.00–599.00 Hz	0.00
↗	04-13	14 th step speed frequency	0.00–599.00 Hz	0.00
↗	04-14	15 th step speed frequency	0.00–599.00 Hz	0.00

05 Motor Parameters

Pr.	Explanation	Settings	Default
05-00	Motor parameter auto-tuning	0: No function 1: Dynamic test for induction motor (IM) 2: Static test for induction motor (IM) 13: High frequency stall test for PM synchronous motor	0
05-01	Full-load current for induction motor 1 (A)	10–120% of the drive's rated current	###
↗ 05-02	Rated power for induction motor 1 (kW)	0.00–655.35 kW	###
↗ 05-03	Rated speed for induction motor 1 (rpm)	0–65535 rpm 1710 (60 Hz, 4 poles); 1410 (50 Hz, 4 poles)	1710
05-04	Number of poles for induction motor 1	2–20	4
05-05	No-load current for induction motor 1 (A)	0.00–Pr.05-01 default	###
05-06	Stator resistance (Rs) for induction motor 1	0.000–65.535 Ω	####
05-07	Rotor resistance (Rr) for induction motor 1	0.000–65.535 Ω	####
05-08	Magnetizing inductance (Lm) for induction motor 1	0.0–6553.5 mH	##
05-09	Stator inductance (Lx) for induction motor 1	0.0–6553.5 mH	##
05-13	Full-load current for induction motor 2 (A)	10–120% of the drive's rated current	###
↗ 05-14	Rated power for induction motor 2 (kW)	0.00–655.35 kW	###
↗ 05-15	Rated speed for induction motor 2 (rpm)	0–65535 rpm 1710 (60 Hz, 4 poles); 1410 (50 Hz, 4 poles)	1710
05-16	Number of poles for induction motor 2	2–20	4
05-17	No-load current for induction motor 2 (A)	0.00–Pr.05-13 default	###
05-18	Stator resistance (Rs) for induction motor 2	0.000–65.535 Ω	####
05-19	Rotor resistance (Rr) for induction motor 2	0.000–65.535 Ω	####
05-20	Magnetizing inductance (Lm) for induction motor 2	0.0–6553.5 mH	##

Pr.	Explanation	Settings	Default
05-21	Stator inductance (Lx) for induction motor 2	0.0–6553.5 mH	##
05-22	Multi-motors (induction) selection	1: Motor 1 2: Motor 2	1
✓ 05-23	Frequency for Y-connection /Δ-connection switch for an induction motor	0.00–599.00 Hz	60.00
05-24	Y-connection /Δ-connection switch for an induction motor	0: Disable 1: Enable	0
✓ 05-25	Delay time for Y-connection /Δ-connection switch for an induction motor	0.000–60.000 sec.	0.200
05-26	Accumulated Watt-second for a motor in low word (W-msec.)	Read only	##
05-27	Accumulated Watt-second for a motor in high word (W-sec.)	Read only	##
05-28	Accumulated Watt-hour for a motor (W-hour)	Read only	##
05-29	Accumulated Watt-hour for a motor in low word (kW-hour)	Read only	##
05-30	Accumulated Watt-hour for a motor in high word (MW-hour)	Read only	##
05-31	Accumulated motor operation time (minutes)	0–1439 min.	0
05-32	Accumulated motor operation time (days)	0–65535 days	0
05-33	Induction motor (IM) or permanent magnet synchronous motor selection	0: Induction motor 1: SPM 2: IPM	0
05-34	Full-load current for a permanent magnet synchronous motor	0–120% of the drive's rated current	##
05-35	Rated power for a permanent magnet synchronous motor	0.00–655.35 kW	###
05-36	Rated speed for a permanent magnet synchronous motor	0–65535 rpm	2000
05-37	Number of poles for a permanent magnet synchronous motor	0–65535	10
05-39	Stator resistance for a permanent magnet synchronous motor	0.000–65.535 Ω	0.000

Pr.	Explanation	Settings	Default
05-40	Permanent magnet synchronous motor Ld	0.00–655.35 mH	0.00
05-41	Permanent magnet synchronous motor Lq	0.00–655.35 mH	0.00
05-43	Ke parameter of a permanent magnet synchronous motor	0–65535 (Unit: V/1000 rpm)	0

06 Protection Parameters (1)

Pr.	Explanation	Settings	Default
✎ 06-00	Low voltage level	115V / 230V: 150.0–220.0 V _{DC} 460V: 300.0–440.0 V _{DC}	180.0 360.0
✎ 06-01	Over-voltage stall prevention	0: Disabled 115V / 230V: 0.0–450.0 V _{DC} 460V: 0.0–900.0 V _{DC}	380.0 760.0
✎ 06-02	Selection for over-voltage stall prevention	0: Traditional over-voltage stall prevention 1: Smart over-voltage stall prevention	0
✎ 06-03	Over-current stall prevention during acceleration	Normal load: 0–150% (100% corresponds to the rated current of the drive) Heavy load: 0–200% (100% corresponds to the rated current of the drive)	120 180
✎ 06-04	Over-current stall prevention during operation	Normal load: 0–150% (100% corresponds to the rated current of the drive) Heavy load: 0–200% (100% corresponds to the rated current of the drive)	120 180
✎ 06-05	Acceleration / deceleration time selection for stall prevention at constant speed	0: By current acceleration / deceleration time 1: By the 1 st acceleration / deceleration time 2: By the 2 nd acceleration / deceleration time 3: By the 3 rd acceleration / deceleration time 4: By the 4 th acceleration / deceleration time 5: By automatic acceleration / deceleration	0
✎ 06-06	Over-torque detection selection (motor 1)	0: No function 1: Continue operation after over-torque detection during constant speed operation 2: Stop after over-torque detection during constant speed operation 3: Continue operation after over-torque detection during RUN 4: Stop after over-torque detection during RUN	0
✎ 06-07	Over-torque detection level (motor 1)	10–250% (100% corresponds to the rated current of the drive)	120
✎ 06-08	Over-torque detection time (motor 1)	0.0–60.0 sec.	0.1
✎ 06-09	Over-torque detection selection (motor 2)	0: No function 1: Continue operation after over-torque detection during constant speed operation 2: Stop after over-torque detection during constant speed operation	

Pr.	Explanation	Settings	Default
		3: Continue operation after over-torque detection during RUN 4: Stop after over-torque detection during RUN	0
06-10	Over-torque detection level (motor 2)	10–250% (100% corresponds to the rated current of the drive)	120
06-11	Over-torque detection time (motor 2)	0.0–60.0 sec.	0.1
06-13	Electronic thermal relay selection (motor 1)	0: Inverter motor (with external forced cooling) 1: Standard motor (motor with fan on shaft) 2: Disable	2
06-14	Electronic thermal relay action time (motor 1)	30.0–600.0 sec.	60.0
06-15	Temperature level over-heat (OH) warning	0.0–110.0°C	105.0
06-16	Stall prevention limit level	0–100% (refer to Pr.06-03–06-04)	100
06-17	Fault record 1	0: No fault record	0
06-18	Fault record 2	1: Over-current during acceleration (ocA)	0
06-19	Fault record 3	2: Over-current during deceleration (ocd)	0
06-20	Fault record 4	3: Over-current during constant speed (ocn)	0
06-21	Fault record 5	4: Ground fault (GFF)	0
06-22	Fault record 6	6: Over-current at stop (ocS)	0
	Fault record 7 (Pr.14-70) Fault record 8 (Pr.14-71) Fault record 9 (Pr.14-72) Fault record 10 (Pr.14-73)	7: Over-voltage during acceleration (ovA) 8: Over-voltage during deceleration (ovd) 9: Over-voltage during constant speed (ovn) 10: Over-voltage at stop (ovS) 11: Low-voltage during acceleration (LvA) 12: Low-voltage during deceleration (Lvd) 13: Low-voltage during constant speed (Lvn) 14: Low-voltage at stop (LvS) 15: Phase loss protection (orP) 16: IGBT over-heat (oH1) 18: TH1 open: IGBT over-heat protection error (tH1o) 21: Drive over-load (oL) 22: Electronic thermal relay protection 1 (EoL1) 23: Electronic thermal relay protection 2 (EoL2) 24: Motor PTC over-heat (oH3) 26: Over-torque 1 (ot1) 27: Over-torque 2 (ot2) 28: Low current (uC)	

Pr.	Explanation	Settings	Default
		31: Memory read-out error (cF2) 33: U-phase current detection error (cd1) 34: V-phase current detection error (cd2) 35: W-phase current detection error (cd3) 36: Clamp current detection error (Hd0) 37: Over-current detection error (Hd1) 40: Auto-tuning error (AUE) 41: PID feedback loss (AFE) 48: Analog current input loss (ACE) 49: External fault input (EF) 50: Emergency stop (EF1) 51: External Base Block (B.B.) 52: Password error (Pcod) 54: Communication error (CE1) 55: Communication error (CE2) 56: Communication error (CE3) 57: Communication error (CE4) 58: Communication time-out (CE10) 61: Y-connection /Δ-connection switch error (ydc) 62: Deceleration energy backup error (dEb) 72: Channel 1 (S1–DCM) safety loop error (STL1) 76: Safe Torque Off (STo) 77: Channel 2 (S2–DCM) safety loop error (STL2) 78: Internal loop error (STL3) 79: U-phase over-current before run (Uoc) 80: V-phase over-current before run (Voc) 81: W-phase over-current before run (Woc) 82: U-phase output phase loss (OPHL) 83: V-phase output phase loss (OPHL) 84: W phase output phase loss (OPHL) 87: Drive overload in low frequency (oL3) 89: Initial rotor position detection error (RoPd) 140: GFF detected when power on (Hd6) 141: GFF before run (BGFF) 142: Auto-tuning error 1 (DC test stage) (AUE1) 143: Auto-tuning error 2 (High frequency test stage) (AUE2) 144: Auto-tuning error 3 (Rotary test stage) (AUE3)	
✎ 06-23	Fault output option 1	0–65535 (refer to bit table for fault code)	0

	Pr.	Explanation	Settings	Default
↗	06-24	Fault output option 2	0–65535 (refer to bit table for fault code)	0
↗	06-25	Fault output option 3	0–65535 (refer to bit table for fault code)	0
↗	06-26	Fault output option 4	0–65535 (refer to bit table for fault code)	0
↗	06-27	Electronic thermal relay selection (motor 2)	0: Inverter motor (with external forced cooling) 1: Standard motor (motor with fan on shaft) 2: Disable	2
↗	06-28	Electronic thermal relay action time (motor 2)	30.0–600.0 sec.	60.0
↗	06-29	PTC detection selection	0: Warn and continue operation 1: Warn and ramp to stop 2: Warn and coast to stop 3: No warning	0
↗	06-30	PTC level	0.0–100.0%	50.0
	06-31	Frequency command for malfunction	0.00–599.00 Hz	Read only
	06-32	Output frequency at malfunction	0.00–599.00 Hz	Read only
	06-33	Output voltage at malfunction	0.0–6553.5 V	Read only
	06-34	DC voltage at malfunction	0.0–6553.5 V	Read only
	06-35	Output current at malfunction	0.00–655.35 Amp	Read only
	06-36	IGBT temperature at malfunction	0.0–6553.5°C	Read only
	06-38	Motor speed at malfunction	0–65535 rpm	Read only
	06-40	Status of the multi-function input terminal at malfunction	0000h–FFFFh	Read only
	06-41	Status of the multi-function output terminal at malfunction	0000h–FFFFh	Read only
	06-42	Drive status at malfunction	0000h–FFFFh	Read only
↗	06-44	STO latch selection	0: STO Latch 1: STO No Latch	0
↗	06-45	Output phase loss detection (OPHL) action	0: Warn and continue operation 1: Warn and ramp to stop 2: Warn and coast to stop 3: No warning	3
↗	06-46	Detection time of output phase loss	0.000–65.535 sec.	0.500
↗	06-47	Current detection level for output phase loss	0.00–100.00%	1.00
↗	06-48	DC brake time of output phase loss	0.000–65.535 sec.	0.000

	Pr.	Explanation	Settings	Default
✎	06-49	LvX auto-reset	0: Disable 1: Enable	0
✎	06-53	Detected input phase loss (OrP) action	0: Warn and ramp to stop 1: Warn and coast to stop	0
✎	06-55	Derating protection	0: Constant rated current and limit carrier wave by load current and temperature 1: Constant carrier frequency and limit load current by setting carrier wave 2: Constant rated current (same as setting 0), but close current limit	0
✎	06-56	PT100 voltage level 1	0.000–10.000 V	5.000
✎	06-57	PT100 voltage level 2	0.000–10.000 V	7.000
✎	06-58	PT100 level 1 frequency protection	0.00–599.00 Hz	0.00
✎	06-59	Delay time for activating PT100 level 1 frequency protection	0–6000 sec.	60
✎	06-60	Software detection GFF current level	0.0–6553.5%	60.0
✎	06-61	Software detection GFF filter time	0.00–655.35 sec.	0.10
	06-63	Operation time of fault record 1 (Days)	0–65535 days	Read only
	06-64	Operation time of fault record 1 (Minutes)	0–1439 min.	Read only
	06-65	Operation time of fault record 2 (Days)	0–65535 days	Read only
	06-66	Operation time of fault record 2 (Minutes)	0–1439 min.	Read only
	06-67	Operation time of fault record 3 (Days)	0–65535 days	Read only
	06-68	Operation time of fault record 3 (Minutes)	0–1439 min.	Read only
	06-69	Operation time of fault record 4 (Days)	0–65535 days	Read only
	06-70	Operation time of fault record 4 (Minutes)	0–1439 min.	Read only
✎	06-71	Low current setting level	0.0–100.0%	0.0
✎	06-72	Low current detection time	0.00–360.00 sec.	0.00

Pr.	Explanation	Settings	Default
06-73	Low current action	0 : No function 1 : Warn and coast to stop 2 : Warn and ramp to stop by the 2 nd deceleration time 3 : Warn and continue operation	0
06-90	Operation time of fault record 5 (Day)	0–65535 days	Read only
06-91	Operation time of fault record 5 (Min.)	0–1439 min.	Read only
06-92	Operation time of fault record 6 (Day)	0–65535 days	Read only
06-93	Operation time of fault record 6 (Min.)	0–1439 min.	Read only

07 Special Parameters

Pr.	Explanation	Settings	Default
✎ 07-00	Software brake level	115V / 230V: 350.0–450.0 V _{DC} 460V: 700.0–900.0 V _{DC}	370.0 740.0
✎ 07-01	DC brake current level	0–100%	0
✎ 07-02	DC brake time at RUN	0.0–60.0 sec.	0.0
✎ 07-03	DC brake time at stop	0.0–60.0 sec.	0.0
✎ 07-04	DC brake frequency at stop	0.00–599.00 Hz	0.00
✎ 07-05	Voltage increasing gain	1–200%	100
✎ 07-06	Restart after momentary power loss	0: Stop operation 1: Speed tracking by speed before the power loss 2: Speed tracking by minimum output frequency	0
✎ 07-07	Allowed power loss duration	0.0–20.0 sec.	2.0
✎ 07-08	Base Block time	0.1–5.0 sec.	0.5
✎ 07-09	Current limit of speed tracking	20–200%	100
✎ 07-10	Restart after fault action	0: Stop operation 1: Speed tracking by current speed 2: Speed tracking by minimum output frequency	0
✎ 07-11	Number of times of auto-restart after fault	0–10	0
✎ 07-12	Speed tracking during start-up	0: Disable 1: Speed tracking by maximum output frequency 2: Speed tracking by motor frequency at start 3: Speed tracking by minimum output frequency	0
✎ 07-13	dEb function selection	0: Disable 1: dEb with auto-acceleration / auto-deceleration, the drive does not output the frequency after the power is restored. 2: dEb with auto-acceleration / auto-deceleration, the drive outputs the frequency after the power is restored.	0
✎ 07-15	Dwell time at acceleration	0.00–600.00 sec.	0.00
✎ 07-16	Dwell frequency at acceleration	0.00–599.00 Hz	0.00
✎ 07-17	Dwell time at deceleration	0.00–600.00 sec.	0.00
✎ 07-18	Dwell frequency at deceleration	0.00–599.00 Hz	0.00

Pr.	Explanation	Settings	Default
07-19	Fan cooling control	0: Fan always ON 1: Fan is OFF after AC motor drive stops for one minute. 2: Fan is ON when AC motor drive runs; fan is OFF when AC motor drive stops. 3: Fan turns ON when temperature reaches around 60°C. 5: Fan turns ON/OFF when the AC motor drive runs/stops and stays in Stand By mode at zero speed.	3
07-20	Deceleration of emergency or forced stop	0: Coast to stop 1: Stop by the 1 st deceleration time 2: Stop by the 2 nd deceleration time 3: Stop by the 3 rd deceleration time 4: Stop by the 4 th deceleration time 5: System deceleration 6: Automatic deceleration	0
07-21	Automatic energy-saving selection	0: Disable 1: Enable	0
07-22	Energy-saving gain	10–1000%	100
07-23	Auto voltage regulation (AVR) function	0: Enable AVR 1: Disable AVR 2: Disable AVR during deceleration	0
07-24	Torque command filter time (V/F and SVC control mode)	0.001–10.000 sec.	0.050
07-25	Slip compensation filter time (V/F and SVC control mode)	0.001–10.000 sec.	0.100
07-26	Torque compensation gain	IM: 0–10 (when Pr.05-33 = 0) PM: 0–5000 (when Pr.05-33 = 1 or 2)	1
07-27	Slip compensation gain (V/F and SVC control mode)	0.00–10.00 (default value is 1 in SVC mode)	0.00
07-29	Slip deviation level	0.0–100.0% 0: No detection	0
07-30	Slip deviation detection time	0.0–10.0 sec.	1.0
07-31	Slip deviation action	0: Warn and continue operation 1: Warn and ramp to stop 2: Warn and coast to stop 3: No warning	0
07-32	Motor shock compensation factor	0–10000	1000
07-33	Auto-restart interval of fault	0.0–6000.0 sec.	60.0

Pr.	Explanation	Settings	Default
07-43	Average PWM signal	1–100 times	1
07-44	PWM signal period	1–2000 ms	1
✎ 07-62	dEb gain	0–65535	8000
✎ 07-71	Torque compensation gain (motor 2)	IM: 0–10 (when Pr.05-33 = 0) PM: 0–5000 (when Pr.05-33 = 1 or 2)	1
✎ 07-72	Slip compensation gain (motor 2)	0.00–10.00 (default value is 1 in SVC mode)	0.00

08 High-function PID Parameters

Pr.	Explanation	Settings	Default
✎ 08-00	Terminal selection of PID feedback	0: No function 1: Negative PID feedback: by analog input (Pr.03-00) 4: Positive PID feedback: by analog input (Pr.03-00) 7: Negative PID feedback: by communication protocol 8: Positive PID feedback: by communication protocol	0
✎ 08-01	Proportional gain (P)	0.0–500.0 (When Pr.08-23 bit1 = 0) 0.00–500.00 (When Pr.08-23 bit1 = 1)	1.00
✎ 08-02	Integral time (I)	0.00–100.00 sec.	1.00
✎ 08-03	Differential time (D)	0.00–1.00 sec.	0.00
✎ 08-04	Upper limit of integral control	0.0–100.0%	100.0
✎ 08-05	PID output command limit (positive limit)	0.0–100.0%	100.0
✎ 08-06	PID feedback value by communication protocol	-200.00–200.00%	0.00
✎ 08-07	PID delay time	0.0–2.5 sec.	0.0
✎ 08-08	Feedback signal detection time	0.0–3600.0 sec.	0.0
✎ 08-09	Feedback signal fault treatment	0: Warn and continue operation 1: Warn and ramp to stop 2: Warn and coast to stop 3: Warn and operate at last frequency	0
✎ 08-10	Sleep frequency	0.00–599.00 Hz	0.00
✎ 08-11	Wake-up frequency	0.00–599.00 Hz	0.00
✎ 08-12	Sleep time	0.0–6000.0 sec.	0.0
✎ 08-13	PID deviation level	1.0–50.0%	10.0
✎ 08-14	PID deviation time	0.1–300.0 sec.	5.0
✎ 08-15	PID feedback filter time	0.1–300.0 sec.	5.0
✎ 08-16	PID compensation selection	0: Parameter setting 1: Analog input	0
✎ 08-17	PID compensation	-100.0–100.0%	0
✎ 08-18	Sleep mode function setting	0: Refer to PID output command 1: Refer to PID feedback signal	0
✎ 08-19	Wake-up integral limit	0.0–200.0%	50.0
08-20	PID mode selection	0: Serial connection 1: Parallel connection	0
08-21	Enable PID to change the operation direction	0: Operating direction can be changed 1: Operating direction cannot be changed	0
✎ 08-22	Wake-up delay time	0.00–600.00 sec.	0.00

Pr.	Explanation	Settings	Default
✎ 08-23	PID control flag	bit 0 = 1: PID running in reverse follows the setting for Pr.00-23. bit 0 = 0: PID running in reverse refers to PID calculated value. bit 1 = 1: PID Kp gain is 2 decimal places. bit 1 = 0: PID Kp gain is 1 decimal place.	2
✎ 08-26	PID output command limit (reverse limit)	0.0–100.0%	100.0
✎ 08-27	PID command acceleration / deceleration time	0.00–655.35 sec.	0.00

09 Communication Parameters

	Pr.	Explanation	Settings	Default
✓	09-00	Communication address	1–254	1
✓	09-01	COM1 transmission speed	4.8–38.4 kbps	9.6
✓	09-02	COM1 transmission fault treatment	0: Warn and continue operation 1: Display error and ramp to stop 2: Display error and coast to stop 3: No warning, no error displayed and continue operation	3
✓	09-03	COM1 time-out detection	0.0–100.0 sec.	0.0
✓	09-04	COM1 communication protocol	1: 7N2 (ASCII) 2: 7E1 (ASCII) 3: 7O1 (ASCII) 4: 7E2 (ASCII) 5: 7O2 (ASCII) 6: 8N1 (ASCII) 7: 8N2 (ASCII) 8: 8E1 (ASCII) 9: 8O1 (ASCII) 10: 8E2 (ASCII) 11: 8O2 (ASCII) 12: 8N1 (RTU) 13: 8N2 (RTU) 14: 8E1 (RTU) 15: 8O1 (RTU) 16: 8E2 (RTU) 17: 8O2 (RTU)	1
✓	09-09	Communication response delay time	0.0–200.0 ms	2.0
	09-10	Communication main frequency	0.00–599.00 Hz	60.00
✓	09-11	Block transfer 1	0–65535	0
✓	09-12	Block transfer 2	0–65535	0
✓	09-13	Block transfer 3	0–65535	0
✓	09-14	Block transfer 4	0–65535	0
✓	09-15	Block transfer 5	0–65535	0
✓	09-16	Block transfer 6	0–65535	0
✓	09-17	Block transfer 7	0–65535	0
✓	09-18	Block transfer 8	0–65535	0
✓	09-19	Block transfer 9	0–65535	0
✓	09-20	Block transfer 10	0–65535	0

	Pr.	Explanation	Settings	Default
✓	09-21	Block transfer 11	0-65535	0
✓	09-22	Block transfer 12	0-65535	0
✓	09-23	Block transfer 13	0-65535	0
✓	09-24	Block transfer 14	0-65535	0
✓	09-25	Block transfer 15	0-65535	0
✓	09-26	Block transfer 16	0-65535	0
	09-30	Communication decoding method	0: Decoding method 1 1: Decoding method 2	1

10 Speed Feedback Control Parameters

	Pr.	Explanation	Settings	Default
↗	10-16	Pulse input type setting	0: Disabled 5: Single-phase input 6: PWM signal input	0
↗	10-29	Top limit of frequency deviation	0.00–100.00 Hz	20.00
↗	10-31	I/F mode, current command	0–150% rated current of the motor	40
↗	10-32	PM FOC sensorless speed estimator bandwidth	0.00–600.00 Hz	5.00
↗	10-34	PM sensorless speed estimator low-pass filter gain	0.00–655.35	1.00
↗	10-42	Initial angle detection pulse value	0.0–3.0	1.0
↗	10-49	Zero voltage time during start-up	00.000–60.000 sec.	00.000
↗	10-51	Injection frequency	0–1200 Hz	500
↗	10-52	Injection magnitude	0.0–200.0 V	15.0/ 30.0
↗	10-53	Position detection method	0: Disabled 1: Internal 1/4 rated current attracting the rotor to zero degrees 2: High frequency injection 3: Pulse injection	0

11 Advanced Parameters

Pr.	Explanation	Settings	Default
11-00	System control	bit 3: Dead time compensation closed bit 7: Save or do not save the frequency	0
11-41	PWM mode selection	0: Two-phase 2: Space vector	2
↗ 11-42	System control flag	0000–FFFFh	0000

12 Function Parameters

Pr.	Explanation	Settings	Default
12-20	Simple positioning stop frequency 0	0.00–599.00 Hz	0.00
12-21	Simple positioning stop frequency 1	0.00–599.00 Hz	5.00
12-22	Simple positioning stop Frequency 2	0.00–599.00 Hz	10.00
12-23	Simple positioning stop frequency 3	0.00–599.00 Hz	20.00
12-24	Simple positioning stop frequency 4	0.00–599.00 Hz	30.00
12-25	Simple positioning stop frequency 5	0.00–599.00 Hz	40.00
12-26	Simple positioning stop frequency 6	0.00–599.00 Hz	50.00
12-27	Simple positioning stop frequency 7	0.00–599.00 Hz	60.00
12-28	Delay time of simple positioning stop 0	0.00–600.00 sec.	0.00
12-29	Delay time of simple positioning stop 1	0.00–600.00 sec.	0.00
12-30	Delay time of simple positioning stop 2	0.00–600.00 sec.	0.00
12-31	Delay time of simple positioning stop 3	0.00–600.00 sec.	0.00
12-32	Delay time of simple Positioning Stop 4	0.00–600.00 sec.	0.00
12-33	Delay time of simple positioning stop 5	0.00–600.00 sec.	0.00
12-34	Delay time of simple positioning stop 6	0.00–600.00 sec.	0.00
12-35	Delay time of simple positioning stop 7	0.00–600.00 sec.	0.00
12-40	Automatic operation mode	0: Disable operation 1: Execute one program cycle 2: Continuously execute program cycles 3: Execute one program cycle step by step 4: Continuously execute one program cycle step by step	0

Pr.	Explanation	Settings	Default
		5: Disable automatic operation, but the direction setting at multi-step speed 1 to 7 are effective	
12-41	PLC program running direction mode	bit 0–bit 7 (0: FWD RUN, 1: REV RUN) bit 0: Direction of auto-operation's main speed bit 1: Direction of 1 st speed for Pr.04-00 bit 2: Direction of 2 nd speed for Pr.04-01 bit 3: Direction of 2 nd speed for Pr.04-02 bit 4: Direction of 2 nd speed for Pr.04-03 bit 5: Direction of 2 nd speed for Pr.04-04 bit 6: Direction of 2 nd speed for Pr.04-05 bit 7: Direction of 2 nd speed for Pr.04-06	0
12-42	Main frequency time setting	0–65500 sec.	0
12-43	1 st speed time setting	0–65500 sec.	0
12-44	2 nd speed time setting	0–65500 sec.	0
12-45	3 rd speed time setting	0–65500 sec.	0
12-46	4 th speed time setting	0–65500 sec.	0
12-47	5 th speed time setting	0–65500 sec.	0
12-48	6 th speed time setting	0–65500 sec.	0
12-49	7 th speed time setting	0–65500 sec.	0

13 Macro / User-Defined Macro

Pr.	Explanation	Settings	Default
13-00	Application selection	00: Disabled 01: User-defined parameter 03: Fan 04: Pump 05: Conveyor 07: Packing	00
13-01 – 13-50	Application parameters (user-defined)		

14 Protection Parameters (2)

Pr.	Explanation	Settings	Default
14-50	Output frequency at malfunction 2	0.00–599.00 Hz	Read only
14-51	DC voltage at malfunction 2	0.0–6553.5 V	Read only
14-52	Output current at malfunction 2	0.00–655.35 Amps	Read only
14-53	IGBT temperature at malfunction 2	-3276.7–3276.7°C	Read only
14-54	Output frequency at malfunction 3	0.00–599.00 Hz	Read only
14-55	DC voltage at malfunction 3	0.0–6553.5 V	Read only
14-56	Output current at malfunction 3	0.00–655.35 Amps	Read only
14-57	IGBT temperature at malfunction 3	-3276.7–3276.7°C	Read only
14-58	Output frequency at malfunction 4	0.00–599.00 Hz	Read only
14-59	DC voltage at malfunction 4	0.0–6553.5 V	Read only
14-60	Output current at malfunction 4	0.00–655.35 Amps	Read only
14-61	IGBT temperature at malfunction 4	-3276.7–3276.7°C	Read only
14-62	Output frequency at malfunction 5	0.00–599.00 Hz	Read only
14-63	DC voltage at malfunction 5	0.0–6553.5 V	Read only
14-64	Output current at malfunction 5	0.00–655.35 Amps	Read only
14-65	IGBT temperature at malfunction 5	-3276.7–3276.7°C	Read only
14-66	Output frequency at malfunction 6	0.00–599.00 Hz	Read only
14-67	DC voltage at malfunction 6	0.0–6553.5 V	Read only
14-68	Output current at malfunction 6	0.00–655.35 Amps	Read only
14-69	IGBT temperature at malfunction 6	-3276.7–3276.7°C	Read only
14-70	Fault record 7	Refer to fault record Pr.06-17-06-22	0
14-71	Fault record 8	Refer to fault record Pr.06-17-06-22	0
14-72	Fault record 9	Refer to fault record Pr.06-17-06-22	0
14-73	Fault record 10	Refer to fault record Pr.06-17-06-22	0

Chapter 12 Description of Parameter Settings

12-1 Description of Parameter Settings

00 Drive Parameters

✎ You can set this parameter during operation.

00-00 Identity Code of the AC Motor Drive

Default: ##

Settings Read Only

00-01 Display AC Motor Drive Rated Current

Default: ##

Settings Read Only

📖 Pr.00-00 displays the identity code of the AC motor drive. Use the following specification table to check if Pr.00-01 setting is the rated current of the AC motor drive. Pr.00-01 corresponds to the identity code of the motor.

📖 The default is the rated current for heavy duty. Set Pr.00-16 to 0 to display the rated current for normal duty.

Series	115V Series: One-Phase				230V Series: One-Phase					
	A		B	C	A/B		B	C		
kW	0.1	0.2	0.4	0.75	0.1	0.2	0.4	0.75	1.5	2.2
HP	0.125	0.25	0.5	1	0.125	0.25	0.5	1	2	3
Identity Code	101	102	103	104	301	302	303	304	305	306
Rated Current for Heavy Duty	0.8	1.6	2.5	4.8	0.8	1.6	2.8	4.8	7.5	11
Rated Current for Normal Duty	1	1.8	2.7	5.5	1	1.8	3.2	5	8.5	12.5





230V Series: Three-Phase											
Frame	A				B	C		D	E		F
kW	0.1	0.2	0.4	0.75	1.5	2.2	3.7	5.5	7.5	11	15
HP	0.125	0.25	0.5	1	2	3	5	7.5	10	15	20
Identity Code	201	202	203	204	205	206	207	208	209	210	211
Rated Current for Heavy Duty	0.8	1.6	2.8	4.8	7.5	11	17	25	33	49	65
Rated Current for Normal Duty	1	1.8	3.2	5	8	12.5	19.5	27	36	51	69

460V Series: Three-Phase											
Frame	A/B		B	C		D		E		F	
kW	0.4	0.75	1.5	2.2	3.7	5.5	7.5	11	15	18.5	22
HP	0.5	1	2	3	5	7.5	10	15	20	25	30
Identity Code	403	404	405	406	407	408	409	410	411	412	413
Rated Current for Heavy Duty	1.5	2.7	4.2	5.5	9	13	17	25	32	38	45
Rated Current for Normal Duty	1.8	3	4.6	6.5	10.5	15.7	20.5	28	36	41.5	49

00-02 Parameter Reset

Default: 0

- Settings
- 0: No Function
 - 1: Parameter write protect
 - 5: Reset KWH display to 0
 - 8: Keypad does not respond
 - 9: Reset all parameters to defaults (base frequency is 50 Hz)
 - 10: Reset all parameters to defaults (base frequency is 60 Hz)
 - 11: Reset all parameters to defaults (base frequency is 50 Hz)
(saves the setting values of user-defined Pr.13-01–13-50)
 - 12: Reset all parameters to defaults (base frequency is 60 Hz)
(saves the setting value of user-defined Pr.13-01–13-50)

-  When set to 1: all parameters are read only except Pr.00-02, 00-07, and 00-08. Set Pr.00-02 to 0 before changing other parameter settings.
-  When set to 5: kWh displayed value can be reset to 0 even when the drive is operating. Pr.05-26, 05-27, 05-28, 05-29, 05-30 are reset to 0.
-  When set to 9 or 10: reset all parameters to defaults. If there is a password set in Pr.00-08, enter the password set in Pr.00-07 to reset to defaults.
-  When set to 9, 10: reboot the motor drive after setting.

00-03 Select Start-up Display

Default: 0

- Settings
- 0: F (frequency command)
 - 1: H (output frequency)
 - 2: U (user-defined) Pr.00-04
 - 3: A (output current)

-  This parameter determines the start-up display page. This is the user-defined choice display according to the setting in Pr.00-04.

00-04 Content of Multi-function Display (User-Defined)

Default: 3

- Settings
- 0: Display output current (A) (Unit: Amps)
 - 1: Display counter value (c) (Unit: CNT)
 - 2: Display actual output frequency (H.) (Unit: Hz)
 - 3: Display DC BUS voltage (v) (Unit: V_{DC})
 - 4: Display output voltage of U, V, W (E) (Unit: V_{AC})
 - 5: Display output power angle of U, V, W (n) (Unit: deg)
 - 6: Display output power of U, V, W (P) (Unit: kW)
 - 7: Display motor speed rpm (r) (Unit: rpm)
 - 10: Display PID feedback (b) (Unit: %)
 - 11: Display signal value of AVI analog input terminal (1.) (Unit: %)
 - 12: Display signal value of ACI analog input terminal (2.) (Unit: %)

- 14: Display temperature of IGBT (i.) (Unit: °C)
- 16: Display digital input status (ON / OFF) (i)
- 17: Display digital output status (ON / OFF) (o)
- 18: Display multi-step speed that is executing (S)
- 19: Display corresponding CPU pin status of digital input (d)
- 20: Display corresponding CPU pin status of digital output (0.)
- 25: Display overload count (0.00–100.00%) (o.) (Unit: %)
- 26: Display GFF Ground Fault (G.) (Unit: %)
- 27: Display DC BUS voltage ripple (r.) (Unit: V_{DC})
- 30: Display user-defined output (U)
- 31: Display Pr.00-05 user gain (K)
- 35: Display control mode:
 - 0= speed control mode (SPD)
- 36: Display current operating carrier frequency of drive (Hz) (J.)
- 38: Display status of drive (6.)
- 41: Display KWH (J) (Unit: kWh)
- 42: Display PID target value (h.) (Unit: %)
- 43: Display PID offset (o.) (Unit: %)
- 44: Display PID output frequency (b.) (Unit: Hz)
- 47: Display master frequency value (A) (Unit: Hz)
- 61: Display the content of the running program (1=tt)

Explanation 1

- It can also display negative values when setting analog input bias (Pr.03-03–03-10).
Example: Assume that AVI input voltage is 0 V, Pr.03-03 is 10.0%, Pr.03-07 is 4 (Bias serves as the center), and Pr.03-10 is 1 allowing negative frequency input.

Explanation 2

Example: If MI1 and MI5 are ON, the following table shows the status of the terminals.

Normally opened contact (N.O.): (0: OFF, 1: ON)

Terminal	MI5	MI4	MI3	MI2	MI1
Status	1	0	0	0	1

- The value is 0000 0000 0001 0001 in binary and 0011H in HEX. When Pr.00-04 is set to “16” or “19”, the u page on the keypad displays 0011h.
- The setting 16 is the ON / OFF status of digital input according to Pr.02-12 setting and the setting 19 is the corresponding CPU pin ON / OFF status of the digital input.
- When MI1 / MI2 default setting is two-wire/ three-wire operation control (Pr.02-00 ≠ 0), and MI3 is set as three-wire, it is not affected by Pr.02-12.
- You can set 16 to monitor the digital input status, and then set 19 to check if the circuit is normal.

Explanation 3

Example:

Assume that RY: Pr.02-13 is set to 9 (Drive is ready). After the drive powers on, if there is no other abnormal status, the contact is ON. The display status is shown below.

Normally opened contact (N.O.):

Terminal	MO1	RY1
Status	0	1

- If Pr.00-04 is set to 17 or 20, it displays in hexadecimal “0001h” with LED u page is ON in the keypad.
- The setting 17 is the ON / OFF status of digital output according to Pr.02-18 setting and the setting 20 is the corresponding CPU pin ON / OFF status of the digital output.
- You can set 17 to monitor the digital output status, and then set 20 to check if the circuit is normal.

Explanation 4

- Setting value 25: when displayed value reaches 100.00%, the drive shows “oL” as an overload warning.

Explanation 5

- Setting value 38:
 - bit 0: The drive is running forward.
 - bit 1: The drive is running backward.
 - bit 2: The drive is ready.
 - bit 3: Errors occurred on the drive.
 - bit 4: The drive is running.
 - bit 5: Warnings occurred on the drive.

00-05 Coefficient Gain in Actual Output Frequency Default: 1.00

Settings 0–160.00



 Sets the user-defined unit coefficient gain. Set Pr.00-04 = 31 to display the calculation result on the screen (calculation = output frequency * Pr.00-05).

00-06 Firmware Version Default: ##

Settings Read only

00-07 Parameter Protection Password Input Default: 0

Settings 0–65535
0–3 (the number of password attempts)

-  This parameter allows you to enter your password (which is set in Pr.00-08) to unlock the parameter protection and to make changes to the parameter.
-  To avoid problems in the future, be sure to write down the password after you set this parameter.

Pr.00-07 and Pr.00-08 are used to prevent personnel from setting other parameters by accident. If you forget the password, clear the password setting by entering 9999 and pressing the ENTER key, then enter 9999 again and press ENTER within 10 seconds. After decoding, all the settings return to default.

When setting is under password protection, all the parameters read 0, except Pr.00-08.

00-08 Parameter Protection Password Setting Default: 0

Settings 0-65535

0: No password protection or password is entered correctly (Pr.00-07)

1: Password has been set

This parameter is for setting the password protection. Password can be set directly the first time. After you set the password, the value of Pr.00-08 is 1, which means password protection is activated. At this time, if you want to change any of the parameter settings, you must enter the correct password in Pr.00-07 to deactivate the password temporarily, and this would make Pr.00-08 become 0. After you finish setting the parameters, reboot the motor drive and the password is activated again.

Entering the correct password in Pr.00-07 only temporarily deactivates the password. To permanently deactivate password protection, set Pr.00-08 to 0 manually. Otherwise, password protection is always reactivated after you reboot the motor drive.

The keypad copy function works only when the password protection is deactivated (temporarily or permanently), and the password set in Pr.00-08 cannot be copied to the keypad. So when copying parameters from the keypad to the motor drive, set the password manually again in the motor drive to activate password protection.

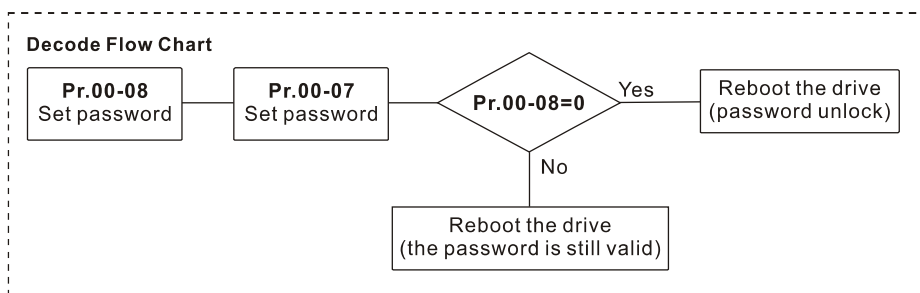
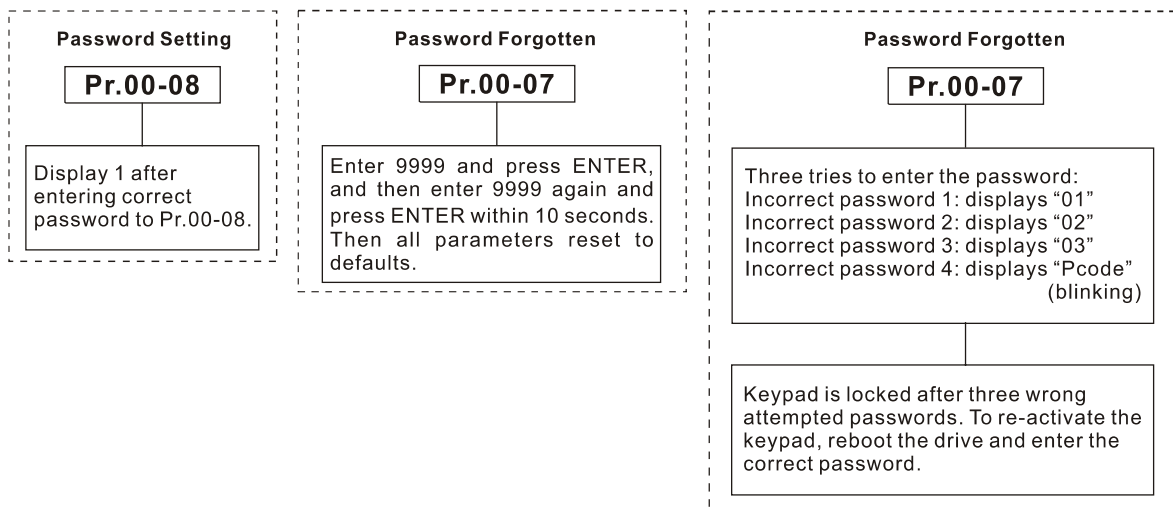

00-10 Control Mode

Default: 0

Settings 0: Speed mode

Determines the control mode of the AC motor drive.

00-11 Speed Control Mode

Default: 0

Settings 0: V/F (IM V/F control)

2: SVC (Pr.05-33 set as IM or PM)

Determines the control mode of the AC motor drive:

0: IM V/F control: you can set the proportion of V/F as required and control multiple motors simultaneously.

2: IM sensorless vector control: get the optimal control by auto-tuning the motor parameters.

When Pr.00-10 = 0 and you set Pr.00-11 to 0, the V/F control diagram is as follows:

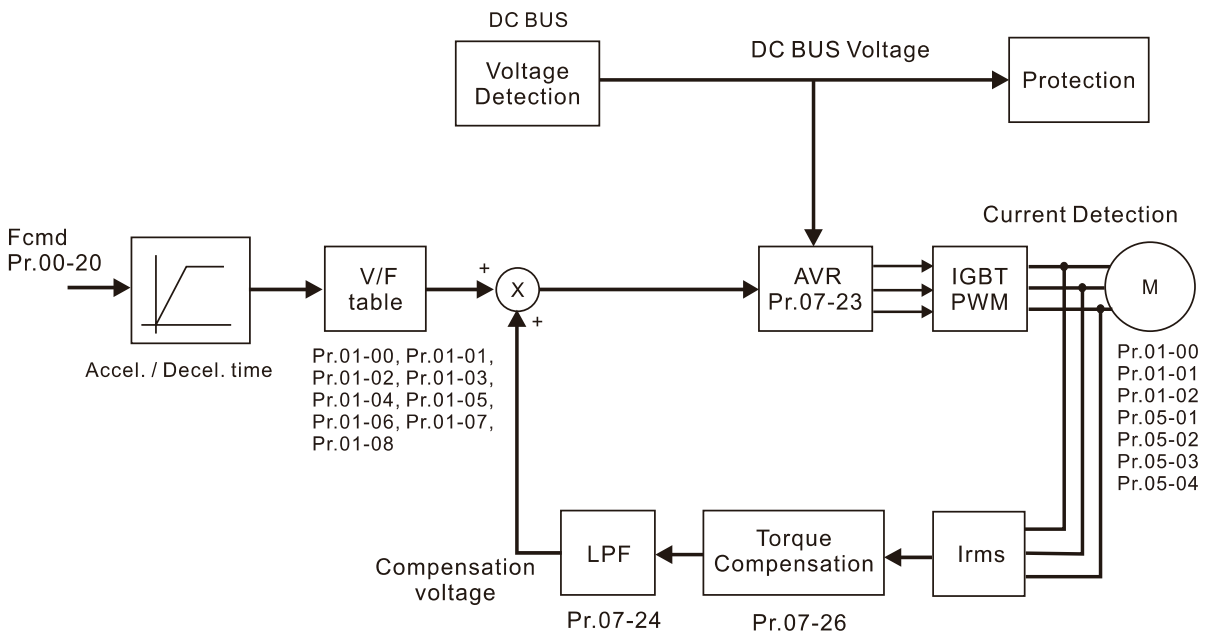



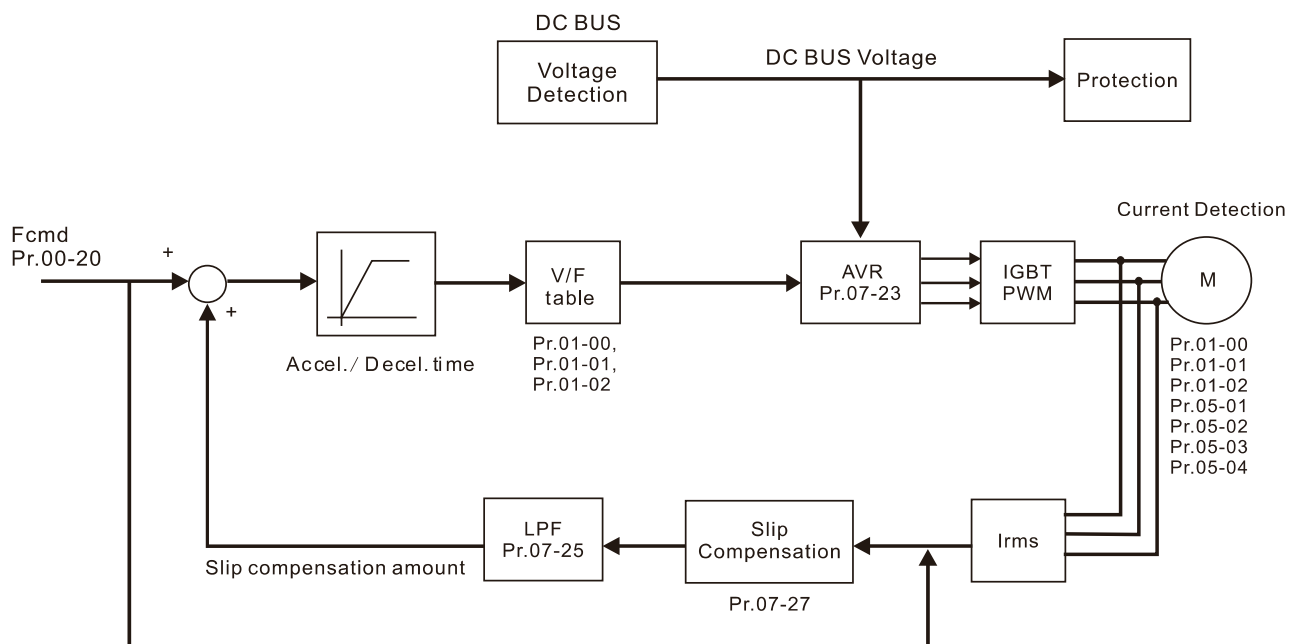

When Pr.00-10 = 0 and you set Pr.00-11 to 2, the sensorless vector control diagram is as follows:



00-16 Load Selection

Default: 1

Settings 0: Normal load
1: Heavy load

-  Normal duty: over-load rated output current 150% in 3 seconds (120%, 1 minute). Refer to Pr.00-17 for the setting for the carrier wave. Refer to Pr.00-01 or the specification table for the rated current.
-  Heavy duty: over-load rated output current 200% in 3 seconds (150%, 1 minute). Refer to Pr.00-17 for the setting for the carrier wave. Refer to Pr.00-01 or the specification table for the rated current.
-  Pr.00-01 varies with the setting value for Pr.00-16. The default value and maximum for Pr.06-03 and Pr.06-04 also vary with the setting value of Pr.00-16.
-  In Normal Duty, the default setting of Pr.06-03 and Pr.06-04 is 120%, and the maximum is 150%. However, if DC voltage is higher than 700 V_{DC} (460V series) or 350 V_{DC} (230V series), then the maximum is 145%.
-  In Heavy Duty, the default setting of Pr.06-03 and Pr.06-04 is 180%, and the maximum is 200%. However, if DC voltage is higher than 700 V_{DC} (460V series) or 350 V_{DC} (230V series), then the maximum is 165%.

00-17 Carrier Frequency



Default: 4

Settings Normal load: 2–15 KHz
Heavy load: 2–15 KHz

-  This parameter determines the PWM carrier frequency for the AC motor drive.

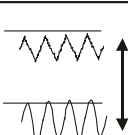
Series	230V		460V	
	1–15 HP [0.75–11 kW]	20–30 HP [15–37 kW]	1–20 HP [0.75–15 kW]	25–40 HP [18.5–55 kW]
Settings Range	02–15 kHz	02–10 kHz	02–15 kHz	02–10 kHz
Normal Duty Default	4 kHz			
Heavy Duty Default	4 kHz			

Carrier Frequency	Acoustic Noise	Electromagnetic Noise or Leakage Current	Heat Dissipation	Current Wave
2 kHz	Significant ↑ ↓ Minimal	Minimal ↑ ↓ Significant	Minimal ↑ ↓ Significant	
8 kHz				
15 kHz				

-  From the table, you see that the PWM carrier frequency has significant influences on the electromagnetic noise, the AC motor drive heat dissipation, and the motor acoustic noise. Therefore, if the surrounding noise is greater than the motor noise, lower the carrier frequency to reduce the temperature rise. Although the motor has quiet operation in the higher carrier frequency, consider the entire wiring and interference.
-  When the carrier frequency is higher than the default, decrease the carrier frequency to protect the drive. Refer to Pr.06-55 for related setting and details.

⚡ **00-20** Master Frequency Command Source (AUTO)

Default: 0

- Settings
- 0: Digital keypad
 - 1: RS-485 serial communication
 - 2: External analog input (Refer to Pr.03-00)
 - 3: External UP / DOWN terminal
 - 4: Pulse input without direction command (Refer to Pr.10-16 without direction)
 - 7: Digital keypad dial

- 📖 You can switch the AUTO / HAND mode with the keypad KPC-CC01 (optional) or the multi-function input terminal (MI) to set the master frequency source.
- 📖 Pr.00-20 and Pr.00-21 are for setting the frequency source and operation source in AUTO mode. Pr.00-30 and Pr.00-31 are for setting the frequency source and operation source in HAND mode.
- 📖 The default for the frequency source or operation source is for AUTO mode. It returns to AUTO mode whenever you cycle the power. If you use a multi-function input terminal to switch between AUTO and HAND mode, the highest priority is the multi-function input terminal. When the external terminal is OFF, the drive does not accept any operation signal and cannot execute JOG.

⚡ **00-21** Operation Command Source (AUTO)

Default: 0

- Settings
- 0: Digital keypad
 - 1: External terminals
 - 2: Communication RS-485 input

- 📖 Determines the operation frequency source in AUTO mode.
- 📖 When you control the operation command by the keypad KPC-CC01 (optional), keys RUN, STOP and JOG (F1) are valid.

⚡ **00-22** Stop Method

Default: 0

- Settings
- 0: Ramp to stop
 - 1: Coast to stop
 - 2: Motor stops by simple positioning

- 📖 Determines how the motor is stopped when the drive receives the Stop command.

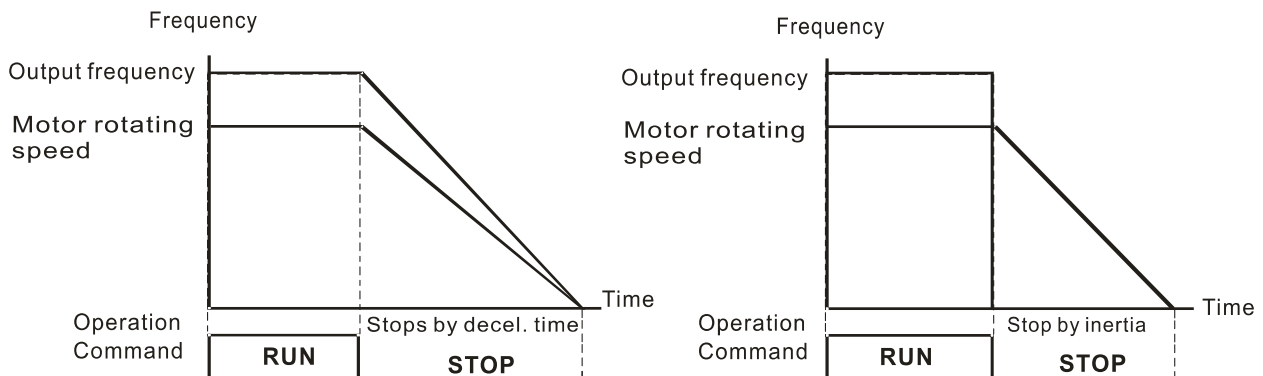

Ramp to Stop and Coast to Stop

1. **Ramp to stop:** the AC motor drive decelerates to 0 or the minimum output frequency (Pr.01-09) according to the set deceleration time, and then to stop (according to Pr.01-07).
2. **Coast to stop:** the AC motor drive stops output immediately, and the motor coasts to stop according to the load inertia.
 - Use “ramp to stop” for the safety of personnel, or to prevent material from being wasted in applications where the motor must stop immediately after the drive stops. You must set the deceleration time accordingly.
 - If idling is allowed, or the load inertia is large, use “coast to stop”. For example, blowers, punching machines and pumps.
3. **Motor stops by simple positioning:** use with the functions for Pr.12-20–12-35.

↗ **00-23** Control of Motor Direction

Default: 0

Settings 0: Enable forward / reverse
 1: Disable reverse
 2: Disable forward

 Enables the AC motor drives to run in the forward and reverse direction. You can use it to prevent a motor from running in a direction that would cause injury or damage to the equipment.

00-24 Digital Operator (Keypad) Frequency Command Memory

Default: Read Only

Settings Read only

 If the keypad is the frequency command source, when Lv or Fault occurs, this parameter stores the current frequency command.

↗ **00-25** User-Defined Characteristics

Default: 0

Settings bit 0–3: user-defined decimal places
 0000b: no decimal place
 0001b: one decimal place
 0010b: two decimal places
 0011b: three decimal places
 bit 4–15: user-defined unit
 000xh: Hz
 001xh: rpm
 002xh: %
 003xh: kg
 004xh: M/S
 005xh: kW
 006xh: HP
 007xh: ppm
 008xh: l/m
 009xh: kg/s

- 00Axh: kg/m
- 00Bxh: kg/h
- 00Cxh: lb/s
- 00Dxh: lb/m
- 00Exh: lb/h
- 00Fhx: ft/s
- 010xh: ft/m
- 011xh: M
- 012xh: ft
- 013xh: degC
- 014xh: degF
- 015xh: mbar
- 016xh: bar
- 017xh: Pa
- 018xh: kPa
- 019xh: mWG
- 01Axh: inWG
- 01Bxh: ftWG
- 01Cxh: Psi
- 01Dxh: Atm
- 01Exh: L/s
- 01Fhx: L/m
- 020xh: L/h
- 021xh: m3/s
- 022xh: m3/h
- 023xh: GPM
- 024xh: CFM

-
- 📖 bit 0–3: the control frequency F page, user-defined unit (Pr.00-04 = d10, PID feedback value) and the number of decimal places (Pr.00-26) which supports up to three decimal places.
 - 📖 bit 4–15: the control frequency F page, user-defined unit (Pr.00-04 = d10, PID feedback value) and the displayed units for Pr.00-26.

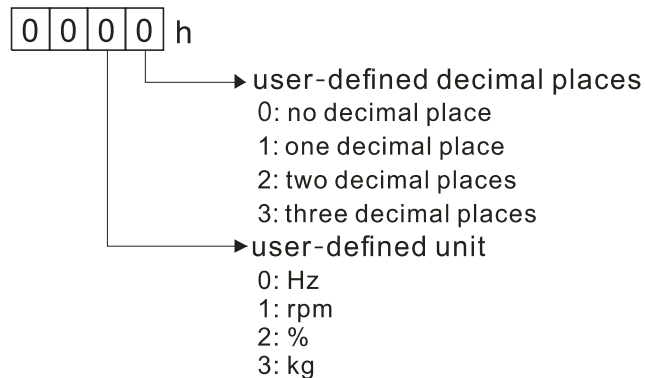

📖 You must convert the setting value to decimal when using the keypad to set parameters.

Example:

If user-defined unit is inWG, user-defined decimal place is the third decimal point, according to the information above, the corresponding unit to inWG is 01Axh (x is the set decimal point), the corresponding unit to the third decimal place is 0003h, then inWG and the third decimal point displayed in hexadecimal is 01A3h, converted to decimal is 01A3h = 419. Thus set Pr.00-25 = 419 to complete the setting.

00-26 Maximum User-Defined Value

Default: 0

- Settings 0: Disable
- 0–65535 (when Pr.00-25 set to no decimal place)
 - 0.0–6553.5 (when Pr.00-25 set to one decimal place)
 - 0.0–655.35 (when Pr.00-25 set to two decimal places)
 - 0.0–65.535 (when Pr.00-25 set to three decimal places)

 When Pr.00-26 is NOT set to 0, the user-defined value is enabled. After selecting the displayed unit and number of decimal points with Pr.00-25, the setting value of Pr.00-26 corresponds to Pr.01-00 (Maximum motor operating frequency), and then the motor operation frequency has a linear relationship with the displayed value on the digital keypad.

Example:

When the frequency set in Pr.01-00 = 60.00 Hz, the maximum user-defined value for Pr.00-26 is 100.0%. This also means that Pr.00-25 is set at 0021h to select % as the unit.



NOTE

The drive display is controlled by the Pr.00-25 setting when Pr.00-25 is properly set and Pr.00-26 is not 0.

00-27 User-Defined Value

Default: Read only

Settings Read only

-  Pr.00-27 displays the user-defined value when Pr.00-26 is not set to 0.
-  The user-defined value is valid only when Pr.00-20 (frequency source) is set to the digital keypad or to RS-485 communication.

00-29 LOCAL / REMOTE Mode

Default: 0

- Settings 0: Standard HOA function
- 1: Switch Local / Remote, the drive stops
 - 2: Switch Local / Remote, the drive runs as the REMOTE setting for frequency and operation status
 - 3: Switch Local / Remote, the drive runs as the LOCAL setting for frequency and operation status
 - 4: Switch Local / Remote, the drive runs as LOCAL setting when switched to Local and runs as REMOTE setting when switched to Remote for frequency and operation status.

- 📖 Select or switch AUTO / HAND mode by using the digital keypad KPC-CC01 (optional) or setting the multi-function input terminal MI = 41, 42.
- 📖 The default for Pr.00-29 is 0 (standard Hand-Off-Auto function). Set the AUTO frequency and operation source with Pr.00-20 and Pr.00-21. Set the HAND frequency and operation source with Pr.00-30 and Pr.00-31.
- 📖 When you set the external terminal (MI) to 41 and 42 (AUTO / HAND mode), Pr.00-29 = 1,2,3,4 are disabled. The external terminal has the highest command priority, and Pr.00-29 functions in standard HOA mode.
- 📖 When you do not set Pr.00-29 to 0, the Local / Remote function is enabled, and the top right corner of digital keypad KPC-CC01 (optional) displays LOC or REM. Set the LOCAL frequency and operation source with Pr.00-20 and Pr.00-21. Set the REMOTE frequency and operation source with Pr.00-30 and Pr.00-31. Select or switch LOC / REM mode with the digital keypad KPC-CC01 (optional) or set the multi-function input terminal MI = 56. The AUTO key of the digital keypad is for the REMOTE function, and HAND key is for the LOCAL function.
- 📖 When you set the external terminal (MI) to 56 for LOC / REM mode selection, if you set Pr.00-29 to 0, then the external terminal function is disabled.
- 📖 When you set the external terminal (MI) to 56 for LOC / REM mode selection, if Pr.00-29 is not set to 0, then AUTO / HAND key is disabled, and the external terminal has the highest command priority.
- 📖 The external terminal (MI) set to 56 for LOC / REM selection is valid only when Pr.00-20 Master Frequency Command Source (AUTO) and Pr.00-21 Operation Command Source (AUTO) are set to external terminals.

↙ **00-30** Master Frequency Command Source (HAND) Default: 0

- Settings
- 0: Digital keypad
 - 1: Communication RS-485 input
 - 2: External analog input (Refer to Pr.03-00)
 - 3: External UP / DOWN terminal
 - 7: Digital keypad dial

📖 Determines the master frequency source in HAND mode.

↙ **00-31** Operation Command Source (HAND) Default: 0

- Settings
- 0: Digital keypad
 - 1: External terminals
 - 2: Communication RS-485 input

📖 Select or switch AUTO / HAND mode by using the digital keypad KPC-CC01 (optional) or setting the multi-function input terminal MI = 41, 42.

📖 Use Pr.00-20 and Pr.00-21 to set the frequency source and the operation source in AUTO mode, and use Pr.00-30 and 00-31 to set the frequency source and the operation source in HAND mode.

 The default for the frequency source and operation source is for AUTO mode. It returns to AUTO mode whenever you cycle power. If you use a multi-function input terminal to switch AUTO / HAND mode, the multi-function input terminal has the highest priority. When the external terminal is OFF, the drive does not accept any operation signal and cannot execute JOG.

00-32 Digital Keypad STOP Function

Default: 0

Settings 0: STOP key disable
1: STOP key enable

 This parameter is valid when the digital keypad is not set as the operation source (Pr.00-21 ≠ 0). When Pr.00-21 = 0, the STOP key on the digital keypad is not affected by this parameter.

00-48 Display Filter Time (Current)

Default: 0.100

Settings 0.001–65.535 sec.

 Minimizes the current fluctuation displayed by digital keypad.

00-49 Display Filter Time (Keypad)

Default: 0.100

Settings 0.001–65.535 sec.

 Minimizes the value fluctuation displayed by digital keypad.

00-50 Software Version (Date)

Default: #####

Settings Read only

 Displays the current drive software version by date.

[This page intentionally left blank]

01 Basic Parameters

✎ You can set this parameter during operation.

01-00 Maximum Operation Frequency of Motor 1

01-52 Maximum Operation Frequency of Motor 2

Default: 60.00 / 50.00

Settings 00.00–599.00 Hz

📖 Determines the drive's maximum operation frequency range. This setting corresponds to the maximum value for the analog input frequency setting signal (0–10 V, 4–20 mA, 0–20 mA, ±10 V).

01-01 Output Frequency of Motor 1

01-35 Output Frequency of Motor 2

Default: 60.00 / 50.00

Settings 00.00–599.00 Hz

📖 Set this value according to the motor's rated frequency from the motor's nameplate. If the motor's rated frequency is 60 Hz, set the value to 60 Hz. If the motor's rated frequency is 50 Hz, set the value to 50 Hz.

01-02 Output Voltage of Motor 1

01-36 Output Voltage of Motor 2

Default: 220.0 / 440.0

Settings 115V/230V series: 0.0–255.0 V
460V series: 0.0–510.0 V

📖 Set this value according to the rated voltage of the motor from the motor's nameplate. If the motor's rated voltage is 220 V, set the value to 220.0 V. If the motor's rated voltage is 200 V, set the value to 200.0 V.

📖 There are a wide variety of motors, but the power system for each country is different. The convenient and economical way to solve this problem is to use an AC motor drive, which can deal with different voltages and frequencies, while supporting the original characteristics and life of the motor.

01-03 Mid-point Frequency 1 of Motor 1

Default: 3.00

Settings 0.00–599.00 Hz

✎ **01-04** Mid-point Voltage 1 of Motor 1

Default: 11.0 / 22.0

Settings 115V/230V series: 0.0–240.0 V
460V series: 0.0–480.0 V

01-37 Mid-point Frequency 1 of Motor 2

Default: 3.00

Settings 0.00–599.00 Hz

↗	01-38	Mid-point Voltage 1 of Motor 2	Default: 11.0 / 22.0
	Settings	115V/230V series: 0.0–240.0 V 460V series: 0.0–480.0 V	
	01-05	Mid-point Frequency 2 of Motor 1	Default: 1.5
	Settings	0.00–599.00 Hz	
↗	01-06	Mid-point Voltage 2 of Motor 1	Default: 5.0 / 10.0
	Settings	115V/230V series: 0.0–240.0 V 460V series: 0.0–480.0 V	
	01-39	Mid-point Frequency 2 of Motor 2	Default: 0.50
	Settings	0.00–599.00 Hz	
↗	01-40	Mid-point Voltage 2 of Motor 2	Default: 2.0 / 4.0
	Settings	115V/230V series: 0.0–240.0 V 460V series: 0.0–480.0 V	
	01-07	Minimum Output Frequency of Motor 1	Default: 0.50
	Settings	0.00–599.00 Hz	
↗	01-08	Minimum Output Voltage of Motor 1	Default: 1.0 / 2.0
	Settings	115V/230V series: 0.0–240.0 V 460V series: 0.0–480.0 V	
	01-41	Minimum Output Frequency of Motor 2	Default: 0.00
	Settings	0.00–599.00 Hz	
↗	01-42	Minimum Output Voltage of Motor 2	Default: 0.0 / 0.0
	Settings	115V/230V series: 0.0–240.0 V 460V series: 0.0–480.0 V	

 The V/F curve setting is usually set by the motor's allowable loading characteristics. If the loading characteristics exceeds the loading limit of the motor, you must pay more attention to the heat dissipation, dynamic balance, and bearing lubrication of the motor.

 If the voltage is too high when the motor is at low frequencies, it may cause motor damage, overheating, and may trigger stalling or over-current protection. To prevent motor damage or

motor fault, be careful when you set the voltage.

The diagram below shows the V/F curve for motor 1. You can also find the V/F curve for motor 2 from the same diagram. For multi-motors selection, refer to multi-function input terminal settings 83 for Pr.02-01-02-05.

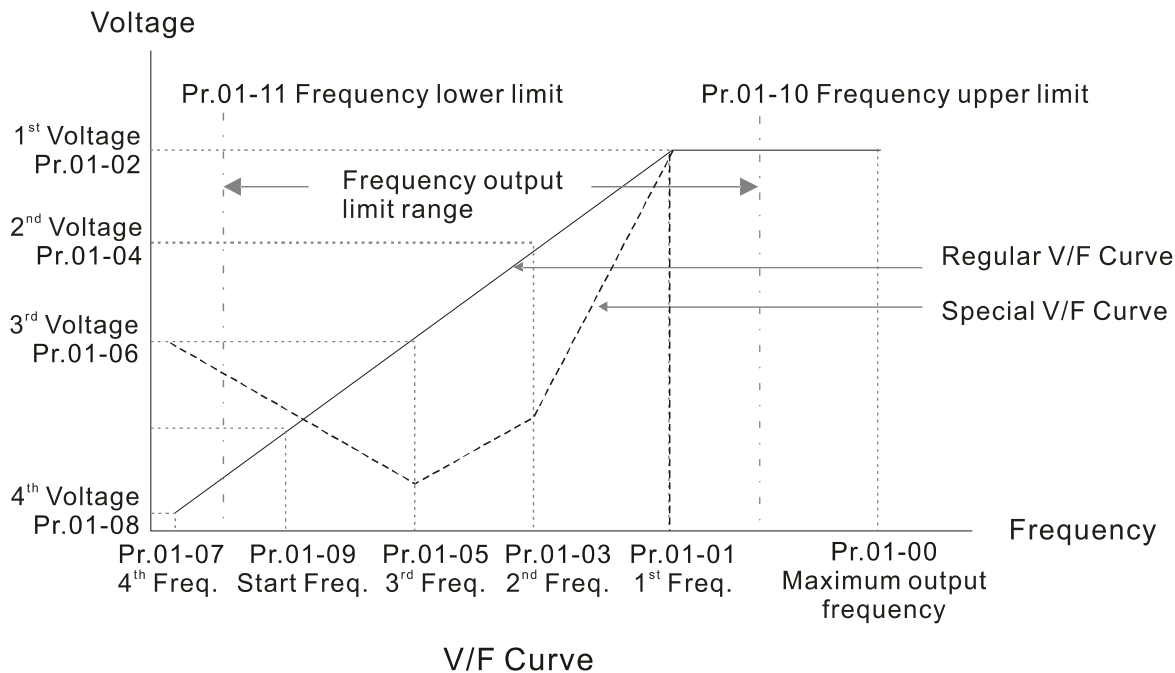

Common settings for the V/F curve:

(1) General purpose

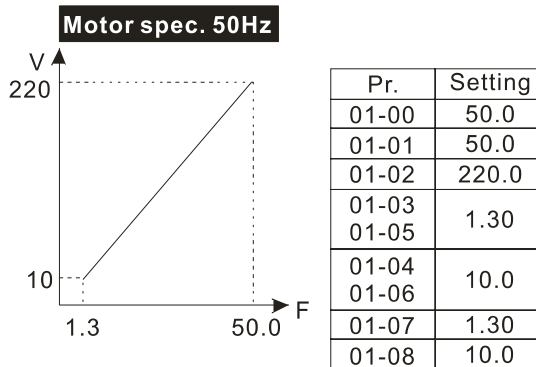
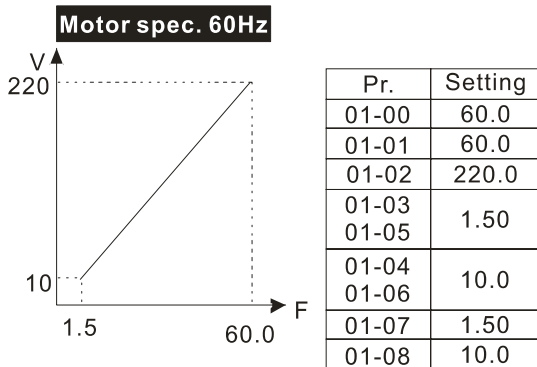

(2) For fan and hydraulic machinery

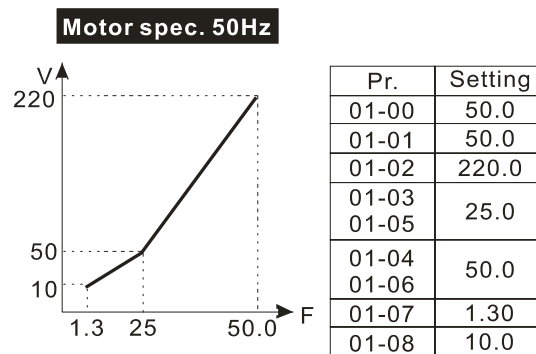
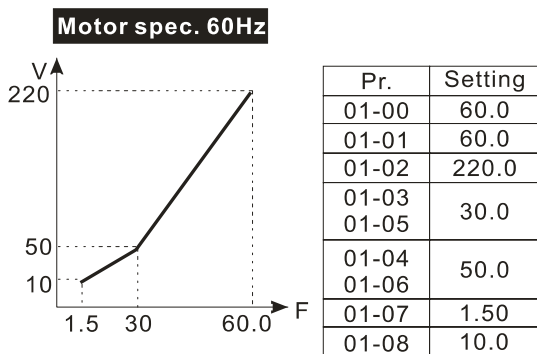

(3) High starting torque

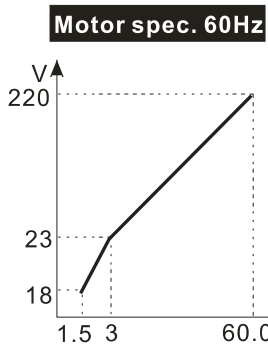

Pr.	Setting
01-00	60.0
01-01	60.0
01-02	220.0
01-03	3.00
01-05	3.00
01-04	23.0
01-06	23.0
01-07	1.50
01-08	18.0

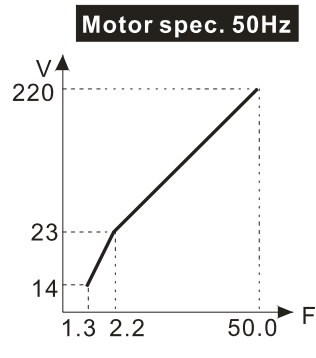

Pr.	Setting
01-00	50.0
01-01	50.0
01-02	220.0
01-03	2.20
01-05	2.20
01-04	23.0
01-06	23.0
01-07	1.30
01-08	14.0

01-09 Start-up Frequency

Default: 0.50

Settings 0.00–599.00 Hz

When the starting frequency is higher than the minimum output frequency, the drive's output is from the starting frequency to the setting frequency. Refer to the following diagram for details.

Fcmd = frequency command;

Fstart = start frequency (Pr.01-09);

fstart = actual start frequency of drive;

Fmin = 4th output frequency setting (Pr.01-07 / Pr.01-41);

Flow = output frequency lower limit (Pr.01-11)

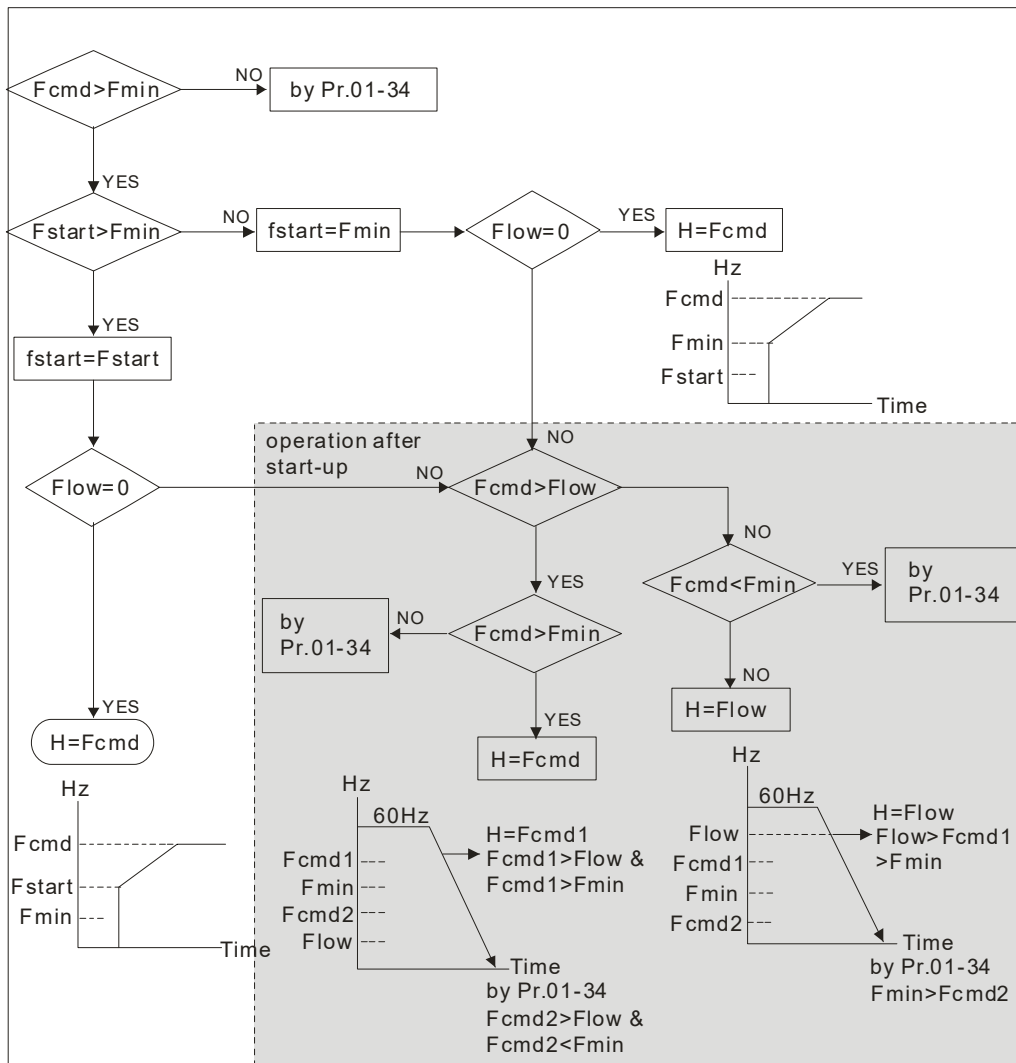

When $F_{cmd} > F_{min}$ and $F_{cmd} < F_{start}$:

If $F_{low} < F_{cmd}$, drive runs directly by F_{cmd} .

If $F_{low} \geq F_{cmd}$, drive runs by F_{cmd} , then rises to F_{low} according to acceleration time.

The output frequency goes directly to 0 when decelerating to F_{min} .

01-10 Output Frequency Upper Limit

Default: 599.00

Settings 0.00–599.00 Hz

01-11 Output Frequency Lower Limit

Default: 0.00

Settings 0.00–599.00 Hz

Use the upper and lower limit output frequency settings to limit the actual output frequency. If the frequency setting is higher than the upper limit (Pr.01-10), the drive uses the upper limit frequency. If the output frequency is lower than lower limit (Pr.01-11) and frequency setting is higher than minimum frequency (Pr.01-07), the drive uses the lower limit frequency. Set the upper limit frequency > lower limit frequency (Pr.01-10 setting value must be > Pr.01-11 setting value).

The upper output frequency limits the maximum output frequency of the drive. If the frequency setting is higher than Pr.01-10, the Pr.01-10 setting limits the output frequency.

When the drive starts the slip compensation function (Pr.07-27) or PID feedback control, the drive output frequency may exceed frequency command but is still limited by this setting.

Related parameters: Pr.01-00 Maximum Operation Frequency.

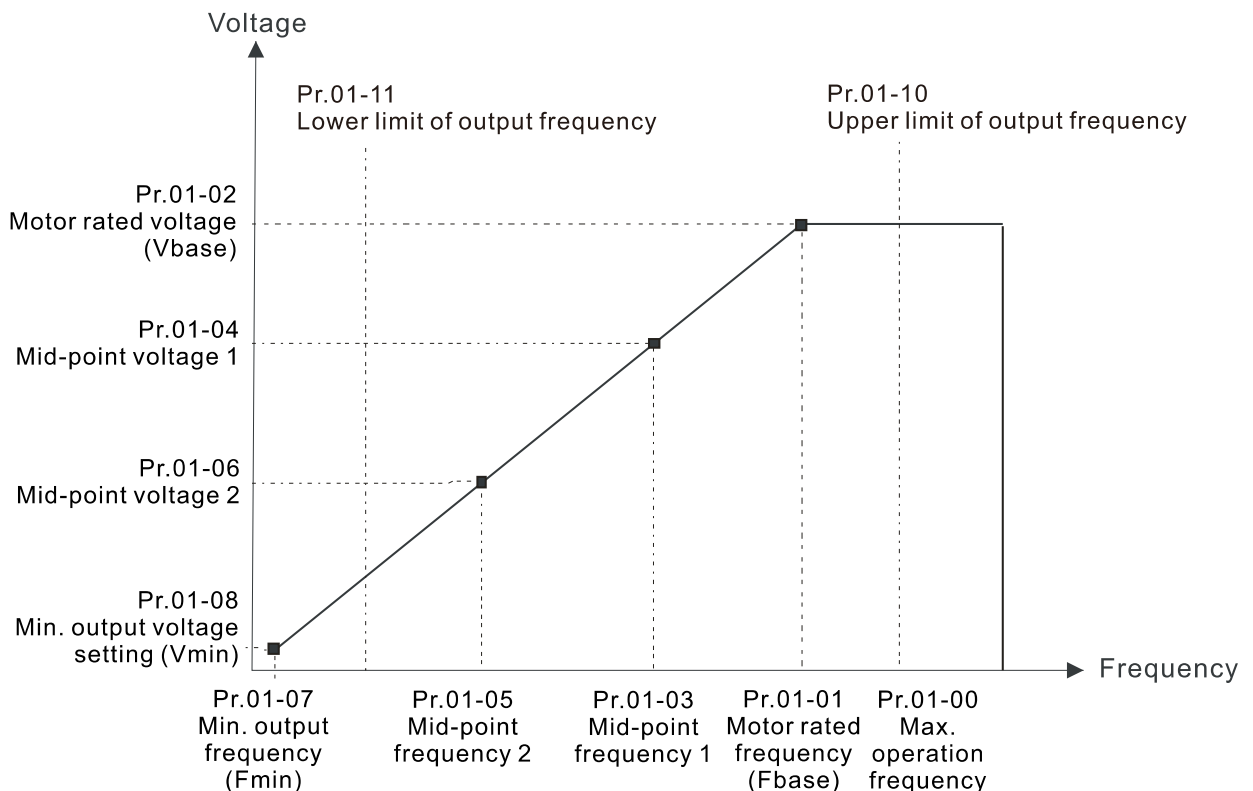

The lower output frequency limits the minimum output frequency of the drive. When the drive frequency command is lower than this setting, the lower limit of the frequency limits the drive output frequency.

- 📖 When the drive starts, it operates from the minimum output frequency (Pr.01-07) and accelerates to the setting frequency. It is not limited by the lower output frequency settings.
- 📖 Use the output frequency upper and lower limit settings to prevent operator misuse, overheating caused by operating at a too low frequency, or damage caused by excessive speed.
- 📖 If the output frequency upper limit setting is 50 Hz and the frequency setting is 60 Hz, the maximum output frequency is 50 Hz.
- 📖 If the output frequency lower limit setting is 10 Hz and the minimum operation frequency setting (Pr.01-07) is 1.5 Hz, the drive operates at 10 Hz when the frequency command is greater than Pr.01-07 and less than 10 Hz. If the frequency command is less than Pr.01-07, the drive stays in ready status with no output.
- 📖 If the frequency output upper limit is 60 Hz and the frequency setting is also 60 Hz, only the Frequency command is limited in 60 Hz. The actual frequency output may exceed 60 Hz if the drive starts the slip compensation function.

↗	01-12	Acceleration Time 1
↗	01-13	Deceleration Time 1
↗	01-14	Acceleration Time 2
↗	01-15	Deceleration Time 2
↗	01-16	Acceleration Time 3
↗	01-17	Deceleration Time 3
↗	01-18	Acceleration Time 4
↗	01-19	Deceleration Time 4
↗	01-20	JOG Acceleration Time
↗	01-21	JOG Deceleration Time

Default: 10.00 / 10.0

Settings Pr.01-45 = 0: 0.00–600.00 sec.

Pr.01-45 = 1: 0.0–6000.0 sec.

- 📖 Use the acceleration time to determine the time required for the AC motor drive to accelerate from 0 Hz to maximum output frequency (Pr.01-00).
- 📖 The acceleration and deceleration time are invalid when using Pr.01-44 Auto-acceleration and Auto-deceleration Setting.
- 📖 Select the acceleration and deceleration time 1, 2, 3, and 4 with the multi-function input terminals settings. The defaults are acceleration and deceleration time 1. With the enabled torque limits and stall prevention functions, the actual acceleration and deceleration time are longer than the above action time.
- 📖 Note that setting the acceleration and deceleration time too short may trigger the protection function (Pr.06-03 Over-current Stall Prevention during Acceleration or Pr.06-01 Over-voltage Stall Prevention).
- 📖 Note that setting the acceleration time too short may cause motor damage or trigger drive protection due to over-current during acceleration.
- 📖 Note that setting the deceleration time too short may cause motor damage or trigger drive protection due to over-current during deceleration or over-voltage.

- Use suitable brake resistors (refer to Chapter 07 Optional Accessories) to decelerate in a short time and prevent over-voltage.
- When you enable Pr.01-24–Pr.01-27 (S-curve acceleration and deceleration begin and arrival time), the actual acceleration and deceleration time are longer than the setting.

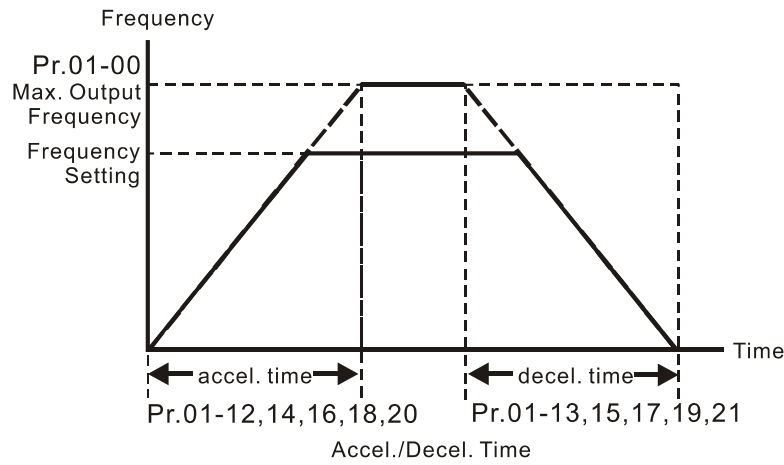

01-22 JOG Frequency Default: 6.00

Settings 0.00–599.00 Hz

- You can use both the external terminal JOG and F1 key on the optional keypad KPC-CC01 to set the JOG function. When the JOG command is ON, the AC motor drive accelerates from 0 Hz to the JOG frequency (Pr.01-22). When the JOG command is OFF, the AC motor drive decelerates from the JOG frequency to stop. The JOG acceleration and deceleration time (Pr.01-20, Pr.01-21) are the time to accelerate from 0.0 Hz to the JOG frequency (Pr.01-22). You cannot execute the JOG command when the AC motor drive is running. When the JOG command is executing, other operation commands are invalid.

01-23 First / Fourth Acceleration / Deceleration Frequency Default: 0.00

Settings 0.00–599.00 Hz

- This function does not require the external terminal switching function; it switches the acceleration and deceleration time automatically by the Pr.01-23 setting. If you set the external terminal, it is based on the external terminal first, and not on Pr.01-23.
- When using this function, set the S-curve acceleration time to 0.

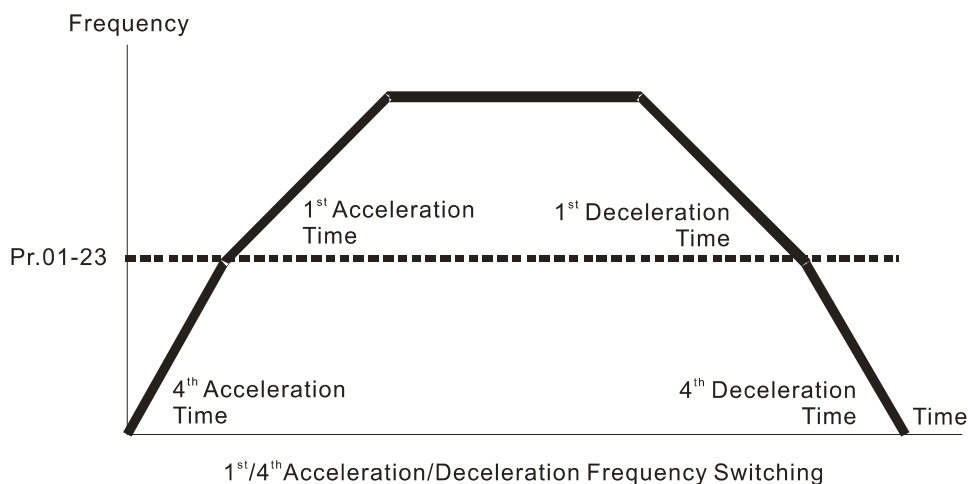

↗	01-24	S-curve Acceleration Begin Time 1
↗	01-25	S-curve Acceleration Arrival Time 2
↗	01-26	S-curve Deceleration Begin Time 1
↗	01-27	S-curve Deceleration Arrival Time 2

Default: 0.20 / 0.2

Settings Pr.01-45 = 0: 0.00–25.00 sec.
 Pr.01-45 = 1: 0.0–250.0 sec.

- 📖 Sets a slow start when the drive begins to accelerate at the start. The acceleration and deceleration curve adjust the S-curve acceleration and deceleration according to the parameter value. When you enable this function, the drive has a different acceleration and deceleration curve based on the acceleration and deceleration time.
- 📖 The S-curve function is disabled when you set the acceleration and deceleration time to 0.
- 📖 When Pr.01-12, 01-14, 01-16, 01-18 ≥ Pr.01-24 and Pr.01-25, the actual acceleration time = Pr.01-12, 01-14, 01-16, 01-18 + (Pr.01-24 + Pr.01-25) / 2.
- 📖 When Pr.01-13, 01-15, 01-17, 01-19 ≥ Pr.01-26 and Pr.01-27, the actual deceleration time = Pr.01-13, 01-15, 01-17, 01-19 + (Pr.01-26 + Pr.01-27) / 2.

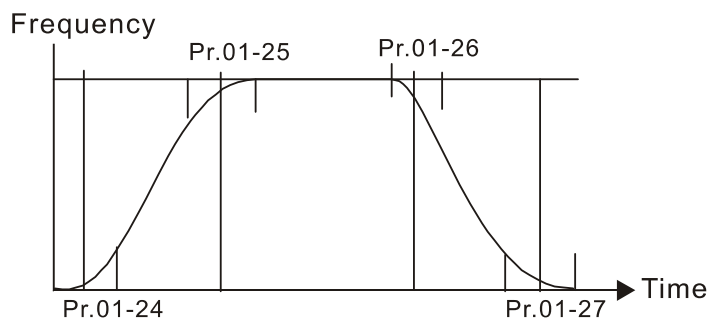

01-28	Skip Frequency 1 (Upper Limit)
01-29	Skip Frequency 1 (Lower Limit)
01-30	Skip Frequency 2 (Upper Limit)
01-31	Skip Frequency 2 (Lower Limit)
01-32	Skip Frequency 3 (Upper Limit)
01-33	Skip Frequency 3 (Lower Limit)

Default: 0.00

Settings 0.00–599.00 Hz

- 📖 Sets the AC drive's skip frequency. The drive's frequency setting skips these frequency ranges. However, the frequency output is continuous. There are no limits for these six parameters and you can combine them. Pr.01-28 does not need to be greater than Pr.01-29; Pr.01-30 does not need to be greater than Pr.01-31; Pr.01-32 does not need to be greater than Pr.01-33. Pr.01-28–01-33 can be set as required. There is no size distinction among these six parameters.
- 📖 These parameters set the skip frequency ranges for the AC motor drive. You can use this function to avoid frequencies that cause mechanical resonance. The skip frequencies are useful when a motor has resonance vibration at a specific frequency bandwidth. Skipping this frequency avoids the vibration. There are three frequency skip zones available. You can set the Frequency command (F) within the range of skip frequencies. Then the output frequency (H) is limited to the

lower limit of skip frequency ranges.

- When accelerating and decelerating, the output frequency still passes through the skip frequency ranges.

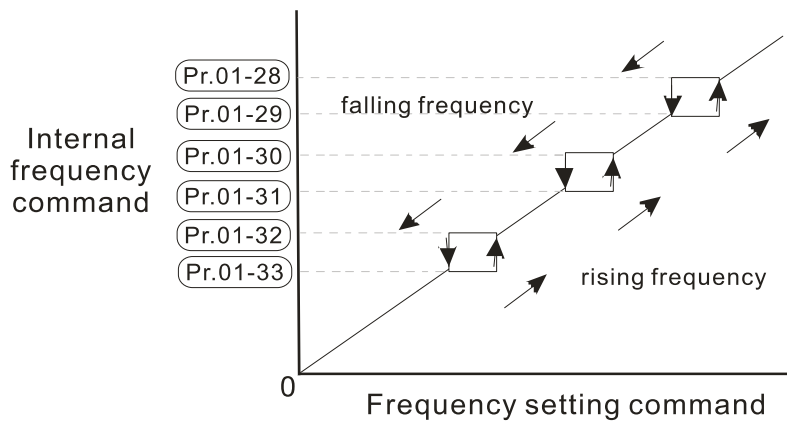

01-34 Zero-speed Mode

Default: 0

- Settings
- 0: Output waiting
 - 1: Zero-speed operation
 - 2: Fmin (refer to Pr.01-07, 01-41)

- When the frequency command of drive is less than Fmin (Pr.01-07, Pr.01-41), the drive operates using this parameter.
- 0: the AC motor drive is in waiting mode without voltage output from terminals U, V, W.
- 1: the drive executes the DC brake by Vmin (Pr.01-08 and Pr.01-42) in V/F and SVC modes.
- 2: the AC motor drive runs using Fmin (Pr.01-07, Pr.01-41) and Vmin (Pr.01-08, Pr.01-42) in V/F and SVC modes.

In V/F and SVC modes:

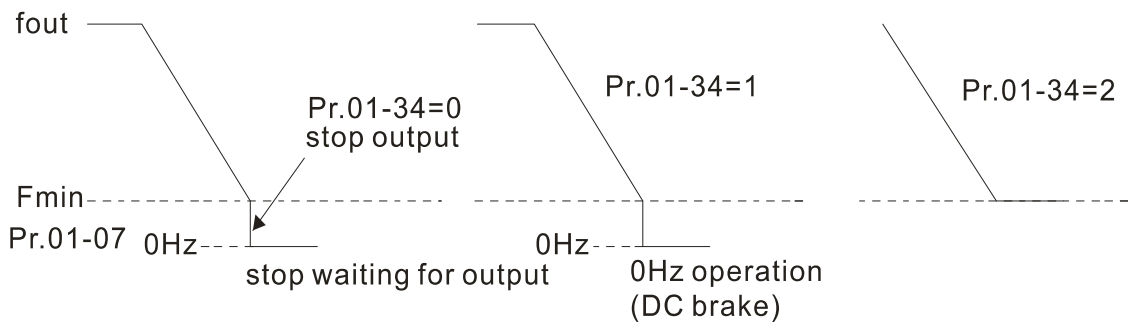

01-43 V/F Curve Selection

Default: 0

- Settings
- 0: V/F curve determined by Pr.01-00–01-08
 - 1: 1.5th V/F curve
 - 2: 2nd V/F curve

- When setting to 0, refer to Pr.01-01–01-08 for the motor 1 V/F curve. For motor 2, refer to Pr.01-35–01-42.
- When setting to 1 or 2, the second and third voltage frequency settings are invalid.
- If the load on the motor is a variable torque load (torque is in direct proportion to rotating speed, such as the load of a fan or a pump), the load torque is low at low rotating speed. Decreasing the

input voltage to make the magnetic field of the input current smaller and reduce flux loss and iron loss for the motor to increase efficiency.

- 📖 When you set the V/F curve to high power, it has lower torque at low frequency, and the drive is not suitable for rapid acceleration and deceleration. Do NOT use this parameter for rapid acceleration and deceleration.

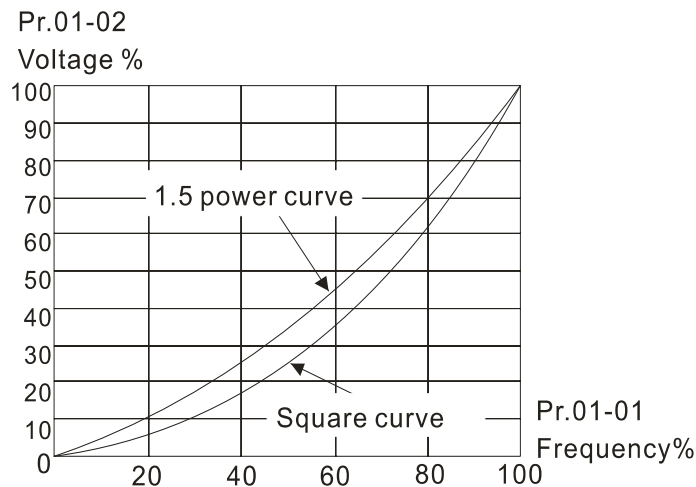

01-44 Auto-Acceleration and Auto-Deceleration Setting

Default: 0

- Settings
- 0: Linear acceleration and linear deceleration
 - 1: Auto-acceleration and linear deceleration
 - 2: Linear acceleration and auto-deceleration
 - 3: Auto-acceleration and auto-deceleration
 - 4: Stall prevention by auto-acceleration and auto-deceleration
(limited by Pr.01-12-01-21)

- 📖 0 (linear acceleration and linear deceleration): the drive accelerates and decelerates according to the setting for Pr.01-12-01-19.
- 📖 1 or 2 (auto/linear acceleration and auto/linear deceleration): the drive reduces the mechanical vibration and prevents the complicated auto-tuning processes. It does not stall during acceleration and has no need for a brake resistor. It can also improve operation efficiency and save energy.
- 📖 3 (auto-acceleration and auto-deceleration): the drive auto-detects the load torque and accelerates from the fastest acceleration time and smoothest start current to the setting frequency. When decelerating, the drive auto-detects the load re-generation and stops the motor smoothly with the fastest deceleration time.
- 📖 4 (stall prevention by auto-acceleration and auto-deceleration (limited by Pr.01-12-01-21)): if the acceleration and deceleration is within a reasonable range, the drive accelerates and decelerates according to Pr.01-12-01-19. If the acceleration and deceleration time is too short, the actual acceleration and deceleration time are greater than the acceleration and deceleration time settings.

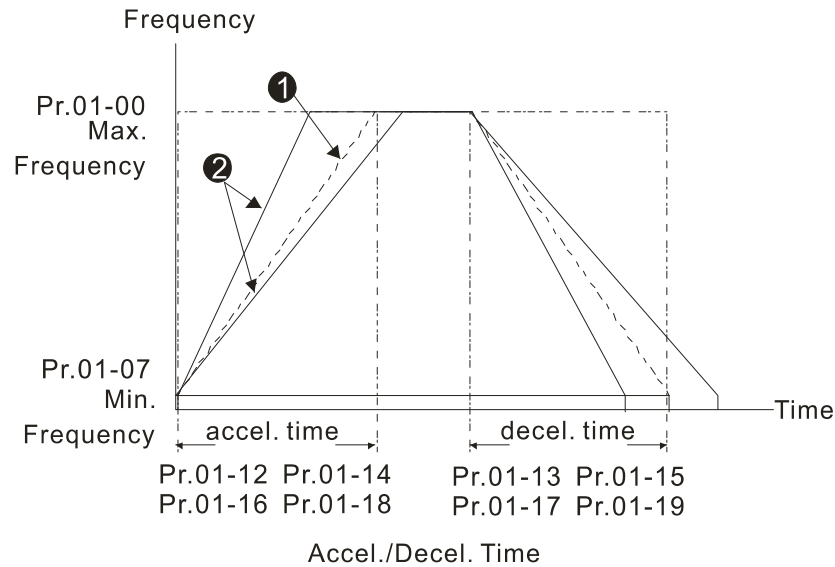

- ① When Pr.01-44 is set to 0.
 ② When Pr.01-44 is set to 3.

01-45 Time Unit for Acceleration and Deceleration and S-Curve

Default: 0

- Settings 0: Unit 0.01 sec.
 1: Unit 0.1 sec.

01-49 Deceleration Method

Default: 0

- Settings 0: Normal deceleration
 1: Overfluxing deceleration
 2: Traction energy control

- 📖 0: decelerate or stop in accordance with the original deceleration setting.
- 📖 1: during deceleration, the drive controls the motor according to the setting of Pr.06-01 and the voltage recovery rate of the DC BUS. The controller starts when the DC BUS voltage reaches 95% of Pr.06-01. When Pr.06-01 is set to 0, the drive controls the motor according to the operating voltage and the voltage recovery rate of the DC BUS. This method decelerates according to the setting for the deceleration time. The fastest actual deceleration time is not less than the deceleration time setting.
- 📖 The actual deceleration time of the motor is higher than the deceleration time setting due to the over-voltage stall prevention.
- 📖 1: use with Pr.06-02 to set to 1 for more efficient over-voltage suppression during deceleration.
- 📖 2: this function can auto-tune output frequency and output voltage to accelerate consumption of DC BUS energy according to drive's ability, so that the actual deceleration time can comply with the parameter setting. Use this setting when over-voltage occurs due to unexpected deceleration time.

[This page intentionally left blank]

02 Digital Input / Output Parameters

✎ You can set this parameter during operation.

02-00 Two-wire / Three-wire Operation Control

Default: 1

- Settings
- 0: No function
 - 1: Two-wire mode 1, power on for operation control
(M1: FWD / STOP, M2: REV / STOP)
 - 2: Two-wire mode 2, power on for operation control
(M1: RUN / STOP, M2: FWD / REV)
 - 3: Three-wire, power on for operation control
(M1: RUN, M2: REV / FWD, M3: STOP)
 - 4: Two-wire mode 1, Quick Start
(M1: FWD / STOP, M2: REV / STOP)
 - 5: Two-wire mode 2, Quick Start
(M1: RUN / STOP, M2: FWD / REV)
 - 6: Three-wire, Quick Start
(M1: RUN, M2: REV / FWD, M3: STOP)

- 📖 In the Quick Start function, the output remains ready for operation. The drive responds to the Start command immediately.
- 📖 When using Quick Start function, the output terminals UVW are with driving voltages in order to output and respond immediately if a Start command is given. Do not touch the terminals or modify the motor wiring to prevent electric shocks.
- 📖 This parameter sets the configuration of the external drive operation control and the Quick Start function. There are six different control modes listed in the following table.

Pr.02-00	External Terminal Control Circuits	
Setting value: 1 Two-wire FWD / STOP REV / STOP		MI1 "OPEN": STOP "CLOSE": FWD MI2 "OPEN": STOP "CLOSE": REV DCM ME300
Setting value: 2 Two-wire RUN / STOP FWD / REV		MI1 "OPEN": STOP "CLOSE": RUN MI2 "OPEN": FWD "CLOSE": REV DCM ME300
Setting value: 3 Three-wire		MI1 "CLOSE": RUN MI3 "OPEN": STOP MI2 REV/FWD: "OPEN": FWD "CLOSE": REV DCM ME300

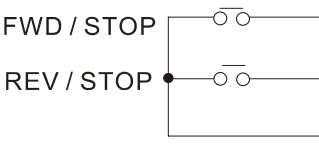
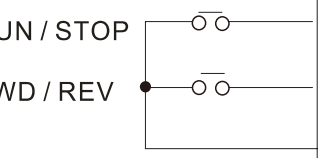
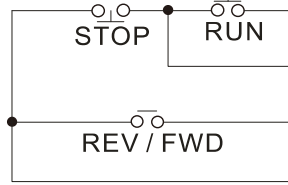
<p>Setting value: 4 Two-wire Quick Start</p>		<p>MI1 "OPEN": STOP "CLOSE": FWD MI2 "OPEN": STOP "CLOSE": REV DCM</p> <p style="text-align: right;">ME300</p>
<p>Setting value: 5 Two-wire Quick Start</p>		<p>MI1 "OPEN": STOP "CLOSE": RUN MI2 "OPEN": FWD "CLOSE": REV DCM</p> <p style="text-align: right;">ME300</p>
<p>Setting value: 6 Three-wire Quick Start</p>		<p>MI1 "CLOSE": RUN MI3 "OPEN": STOP MI2 REV/FWD: "OPEN": FWD "CLOSE": REV DCM</p> <p style="text-align: right;">ME300</p>

02-01	Multi-function Input Command 1 (MI1)	Default: 0
02-02	Multi-function Input Command 2 (MI2)	Default: 1
02-03	Multi-function Input Command 3 (MI3)	Default: 2
02-04	Multi-function Input Command 4 (MI4)	Default: 3
02-05	Multi-function Input Command 5 (MI5)	

- Settings
- 0: No function
 - 1: Multi-step speed command 1 / multi-step position command 1
 - 2: Multi-step speed command 2 / multi-step position command 2
 - 3: Multi-step speed command 3 / multi-step position command 3
 - 4: Multi-step speed command 4 / multi-step position command 4
 - 5: Reset
 - 6: JOG operation (by KPC-CC01 or external control)
 - 7: Acceleration / deceleration speed inhibit
 - 8: The first and second acceleration / deceleration time selection
 - 9: The third and fourth acceleration / deceleration time selection
 - 10: EF input (Pr.07-20)
 - 11: B.B. input from external (Base Block)
 - 12: Output stop
 - 13: Cancel the setting for auto-acceleration / auto-deceleration time
 - 15: Rotating speed command from AVI
 - 18: Forced to stop (Pr.07-20)

- 19: Digital up command
- 20: Digital down command
- 21: PID function disabled
- 22: Clear the counter
- 23: Input the counter value (MI4)
- 24: FWD JOG command
- 25: REV JOG command
- 28: Emergency stop (EF1)
- 29: Signal confirmation for Y-connection
- 30: Signal confirmation for Δ -connection
- 38: Disable write EEPROM function
- 40: Force coasting to stop
- 41: HAND switch
- 42: AUTO switch
- 49: Enable Drive
- 50: Master dEb input
- 56: Local / Remote selection
- 69: Auto-activate preheating function
- 71: Disable PID function, force PID output return to 0
- 72: Disable PID function, retain the output value before disabled
- 73: Force PID integral gain return to 0, disable integral
- 74: Reverse PID feedback
- 83: Multi-motors (IM) selection bit 0
- 94: Programmable AUTO RUN
- 95: Pausing AUTO RUN
- 98: Simple positioning stop by forward limit
- 99: Simple positioning stop by reverse limit

 This parameter selects the functions for each multi-function terminal.

 When Pr.02-00 = 0, you can set multi-function options with the multi-function input terminals MI1, MI2.

 When Pr.02-00 \neq 0, the multi-function input terminals MI1, MI2 work in accordance with the setting values for Pr.02-00.

Example:

If Pr.02-00 = 1: multi-function input terminal MI1 = FWD / STOP,
multi-function input terminal MI2 = REV / STOP.

If Pr.02-00 = 2: multi-function input terminal MI1 = RUN / STOP,
multi-function input terminal MI2 = FWD / REV.

 If Pr.02-00 is set to three-wire operation control, terminal MI3 is for the STOP contact. The function set previously for this terminal is automatically invalid.

Summary of function settings

Take the normally opened contact (N.O.) for example, ON: contact is closed, OFF: contact is open.

Settings	Functions	Descriptions
0	No function	
1	Multi-step speed command 1 / multi-step position command 1	<p>You can set 15 steps of speed or 15 positions with the digital status of these 4 terminals. You can use 16-steps of speed if you include the master speed when setting as 15 steps of speed (refer to Parameter Group 04 Multi-step Speed Parameters).</p>
2	Multi-step speed command 2 / multi-step position command 2	
3	Multi-step speed command 3 / multi-step position command 3	
4	Multi-step speed command 4 / multi-step position command 4	
5	Reset	Use this terminal to reset the drive after clearing a drive fault.
6	JOG operation	<p>This function is valid when the source of the operation command is the external terminals.</p> <p>The JOG operation executes when the drive stops completely. While running, you can still change the operation direction, and the STOP key on the keypad is valid. Once the external terminal receives the OFF command, the motor stops in the JOG deceleration time. Refer to Pr.01-20–01-22 for details.</p> <p>The diagram shows the JOG frequency (Pr.01-22) and minimum output frequency (Pr.01-07) over time. The JOG operation starts when the external terminal (Mix-GND) is turned ON. The frequency ramps up during the JOG acceleration time (Pr.01-20) and then remains constant. When the terminal is turned OFF, the frequency ramps down during the JOG deceleration time (Pr.01-21) before reaching the minimum output frequency.</p>
7	Acceleration / deceleration speed inhibit	<p>When you enable this function, the drive stops acceleration or deceleration immediately. After you disable this function, the AC motor drive starts to accelerate or decelerate from the inhibit point.</p> <p>The diagram shows the setting frequency and actual operation frequency over time. The actual operation frequency follows the setting frequency but is inhibited (flattened) during acceleration and deceleration phases when the Mix-GND terminal is ON. When the terminal is OFF, the actual operation frequency resumes its normal acceleration and deceleration profile. The inhibit areas are labeled as 'Accel. inhibit area' and 'Decel. inhibit area'.</p>

Settings	Functions	Descriptions
8	The first, second acceleration / deceleration time selection	You can select the acceleration and deceleration time of the drive with this function, or from the digital status of the terminals; there are four acceleration and deceleration selections.
9	The third, fourth acceleration / deceleration time selection	
10	EF input (EF: External Fault)	For external fault input. The drive decelerates according to the Pr.07-20 setting, and the keypad shows "EF" (it shows the fault record when an external fault occurs). The drive keeps running until the fault is cleared (terminal status restored) after RESET.
11	B.B. input from external (B.B.: Base Block)	ON: the output of the drive stops immediately. The motor is in free run and the keypad displays the B.B. signal. Refer to Pr.07-08 for details.
12	Output stop (output pause)	<p>When the switch is ON, output of the drive stops immediately and the motor is in free run status. The drive is in output waiting status until the switch is turned to OFF, and then the drive restarts and runs to the current setting frequency.</p> <p>MIX-GND ON OFF ON</p> <p>Operation command ON</p>
13	Cancel the setting for auto-acceleration / auto-deceleration time	Set Pr.01-44 to one of the 01–04 setting modes before using this function. When this function is enabled, OFF is for auto mode and ON is for linear acceleration / deceleration.
15	Rotating speed command from AVI	ON: force the source of the frequency to be AVI. If the rotating speed commands are set to AVI and ACI at the same time, the priority is AVI > ACI.
18	Forced to stop	ON: the drive ramps to stop according to the Pr.07-20 setting.
19	Digital up command	ON: the frequency of the drive increases or decreases by one unit. If this function remains ON continuously, the frequency increases or decreases according to Pr.02-09 / Pr.02-10.
20	Digital down command	The Frequency command returns to zero when the drive stops, and the displayed frequency is 0.00 Hz. If you select Pr.11-00, bit 7 = 1, the frequency is not saved.

Settings	Functions	Descriptions
21	PID function disabled	ON: the PID function is disabled.
22	Clear counter command	ON: the current counter value is cleared and displays 0. The drive counts up when this function is disabled.
23	Input the counter value (MI 6)	On: the counter value increases by 1. Use the function with Pr.02-19.
24	FWD JOG command	This function is valid when the source of the operation command is external terminal. ON: the drive executes forward JOG. When executing the JOG command in torque mode, the drive automatically switches to speed mode. The drive returns to torque mode after the JOG command is complete.
25	REV JOG command	This function is valid when the source of the operation command is external terminal. ON: the drive executes reverse JOG. When executing the JOG command in torque mode, the drive automatically switches to speed mode. The drive returns to torque mode after the JOG command is complete.
28	Emergency stop (EF1)	<p>ON: the output of the drive stops immediately, displays “EF1” on the keypad, and the motor is in free run status. The drive keeps running until the fault is cleared after you press RESET on the keypad (EF: External Fault).</p> <p>The diagram illustrates the behavior of the drive during an emergency stop. It shows three traces: Voltage, Frequency, and Setting frequency. The Voltage trace shows a step-down to zero when Mix-GND is turned ON, followed by a step-up when Mix-GND is turned OFF. The Frequency trace shows a ramp-up to a 'Setting frequency' level, a drop to zero when Mix-GND is ON, and a second ramp-up when Mix-GND is OFF and Reset is ON. The Setting frequency trace is a constant horizontal line at the 'Setting frequency' level. Below the traces are logic signals: Mix-GND (ON/OFF/ON), Reset (ON/OFF), and Operation command (ON).</p>
29	Signal confirmation for Y-connection	When the control mode is V/F, ON: the drive operates by the first V/F.
30	Signal confirmation for Δ-connection	When the control mode is V/F, ON: the drive operates by the second V/F.
38	Disable EEPROM write function (parameters memory disable)	ON: writing to EEPROM is disabled. Changed parameters are not saved after power off.
40	Force coasting to stop	ON: during operation, the drive free runs to stop.

Settings	Functions	Descriptions															
41	HAND switch	<ol style="list-style-type: none"> When the MI terminal switches to OFF, it executes a STOP command. Therefore, if the MI terminal switches to OFF during operation, the drive stops. Use the optional keypad KPC-CC01 to switch between HAND and AUTO. The drive stops first, and then switches to HAND or AUTO status. 															
42	AUTO switch	<ol style="list-style-type: none"> The optional digital keypad KPC-CC01 displays the current status of the drive (HAND / OFF / AUTO). <table border="1" data-bbox="807 546 1347 707"> <thead> <tr> <th></th> <th>bit 1</th> <th>bit 0</th> </tr> </thead> <tbody> <tr> <td>OFF</td> <td>0</td> <td>0</td> </tr> <tr> <td>AUTO</td> <td>0</td> <td>1</td> </tr> <tr> <td>HAND</td> <td>1</td> <td>0</td> </tr> <tr> <td>OFF</td> <td></td> <td>1</td> </tr> </tbody> </table> 		bit 1	bit 0	OFF	0	0	AUTO	0	1	HAND	1	0	OFF		1
	bit 1	bit 0															
OFF	0	0															
AUTO	0	1															
HAND	1	0															
OFF		1															
49	Enable drive	<p>When the drive is enabled, the RUN command is valid. When the drive is disabled, the RUN command is invalid. When the drive is operating, the motor coasts to stop. This function varies with MO=45.</p>															
50	Master dEb input	Enter the message setting in this parameter when the master triggers dEb. This ensures that the slave also triggers dEb, then master and slave stop simultaneously.															
56	LOCAL / REMOTE selection	<p>Use Pr.00-29 to select LOCAL / REMOTE mode (refer to Pr.00-29). When Pr.00-29 is not set to 0, the optional digital keypad KPC-CC01 displays the LOC / REM status.</p> <table border="1" data-bbox="762 1200 1123 1296"> <thead> <tr> <th></th> <th>bit 0</th> </tr> </thead> <tbody> <tr> <td>REM</td> <td>0</td> </tr> <tr> <td>LOC</td> <td>1</td> </tr> </tbody> </table>		bit 0	REM	0	LOC	1									
	bit 0																
REM	0																
LOC	1																
69	Auto-activate preheating function	When you set MI=69 (auto-activate preheating function), the enabling and disabling for preheating function is determined by MI.															
71	Disable PID function, force PID output return to 0	When the master and auxiliary frequencies are enabled and when using the PID function, ON: PID does not operate, returns the integral value to 0, and forces the PID output return to 0.															
72	Disable PID function, retain the output value before disabled	When the master and auxiliary frequency are enabled, and the PID function is enabled, and the terminal contact of this parameter is ON, then PID does not operate, and its output value remains the same as the value before it was disabled.															

Settings	Functions	Descriptions														
83	Multi-motors (IM) selection bit 0	<p>ON: parameters can be changed</p> <p>Example: MI1 = 83</p> <table border="1"> <thead> <tr> <th rowspan="2">MI1</th> <th rowspan="2">Motor Selection</th> <th colspan="2">Related Motor Parameter</th> </tr> <tr> <th>Max. Operation Frequency</th> <th>V/F Curve Parameter</th> </tr> </thead> <tbody> <tr> <td>OFF</td> <td>Motor 1</td> <td>Pr.01-00</td> <td>Pr.01-01–01-08</td> </tr> <tr> <td>ON</td> <td>Motor 2</td> <td>Pr.01-52</td> <td>Pr.01-35–01-42</td> </tr> </tbody> </table>	MI1	Motor Selection	Related Motor Parameter		Max. Operation Frequency	V/F Curve Parameter	OFF	Motor 1	Pr.01-00	Pr.01-01–01-08	ON	Motor 2	Pr.01-52	Pr.01-35–01-42
MI1	Motor Selection	Related Motor Parameter														
		Max. Operation Frequency	V/F Curve Parameter													
OFF	Motor 1	Pr.01-00	Pr.01-01–01-08													
ON	Motor 2	Pr.01-52	Pr.01-35–01-42													
94	Programmable AUTO RUN															
95	Pausing AUTO RUN	<p>When the functional terminals for programmable auto-run enable, the output frequency of the AC motor drive operates automatically according to the settings for multi-step speed.</p> <p>You can pause the terminals to temporarily stop the running program during operation. The program resumes running after the pausing finishes.</p>														
98	Simple positioning stop by forward limit	If the motor receives this signal while running forward, it stops running forward.														
99	Simple positioning stop by reverse limit	If the motor receives this signal while running reverse, it stops running reverse.														

⚡ **02-09** UP / DOWN Key Mode

Default: 0

- Settings
- 0: UP / DOWN by acceleration / deceleration time
 - 1: UP / DOWN constant speed (Pr.02-10)
 - 2: Pulse signal (Pr.02-10)
 - 3: External terminals UP / DOWN key mode

⚡ **02-10** Constant Speed the Acceleration / Deceleration Speed of the UP / DOWN Key

Default: 0.001

Settings 0.001–1.000 Hz / ms

- 📖 Use when the multi-function input terminals are set to 19, 20 (UP / DOWN command).
The frequency increases or decreases according to Pr.02-09 and Pr.02-10.
- 📖 When Pr.11-00 bit 7=1, the frequency is not saved. The Frequency command returns to zero when the drive stops, and the displayed frequency is 0.00 Hz. At this time, the increasing or decreasing frequency command (F) by using the UP or DOWN key is valid only when the drive is running.
- 📖 When Pr.02-09 is set to 0: the increasing or decreasing frequency command (F) operates according to the setting for acceleration or deceleration time (refer to Pr.01-12–01-19).

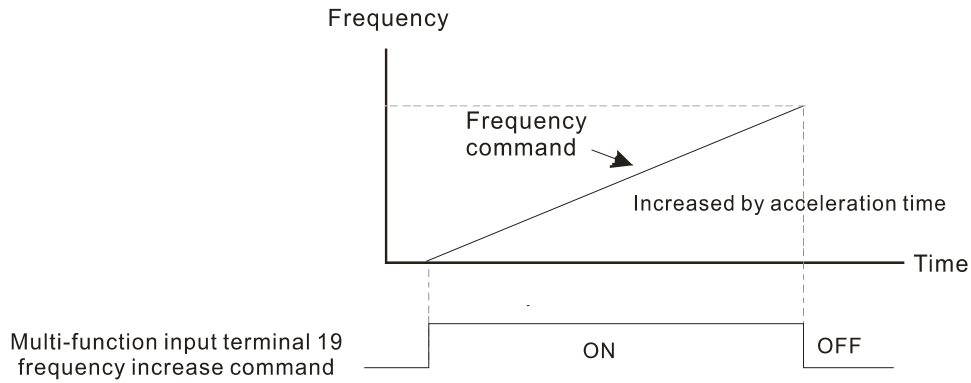

- When Pr.02-09 is set to 1: the increasing / decreasing frequency command (F) operates according to the setting of Pr.02-10 (0.001–1.000 Hz/ms).

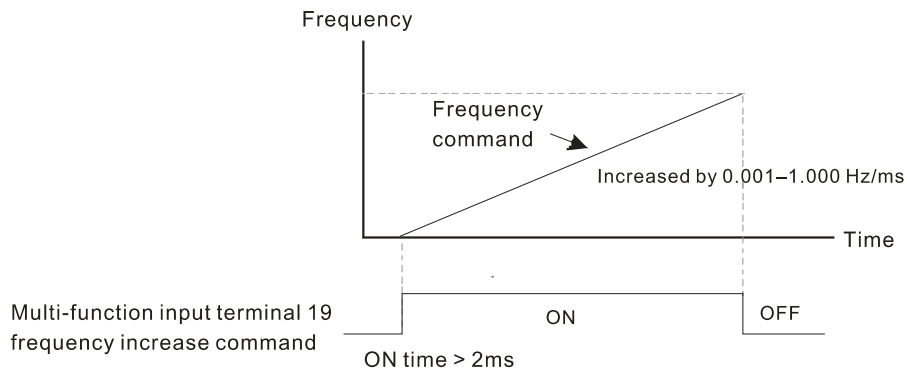

02-11 Multi-function Input Response Time

Default: 0.005

Settings 0.000–30.000 sec.

- Use this parameter to set the response time of the digital input terminals MI1–MI5.
- This function is to delay and confirm the digital input terminal signal. The time for delay is also the time for confirmation. The confirmation prevents interference that could cause error in the input to the digital terminals. But in the meanwhile, it delays the response time though confirmation improves accuracy.

02-12 Multi-function Input Mode Selection

Default: 0000

Settings 0000h–FFFFh (0: N.O.; 1: N.C.)

- This parameter setting is in hexadecimal.
- This parameter sets the status of the multi-function input signal (0: normally open; 1: normally closed) and it is not affected by the status of SINK / SOURCE.
- bit 0–bit 4 correspond to MI1–MI5.
- The default for bit 0 (MI1) is FWD terminal, and the default for bit 1 (MI2) is REV terminal. You cannot use this parameter to change the input mode when Pr.02-00 ≠ 0.
- You can change the terminal ON / OFF status through communications.
For example: MI3 is set to 1 (multi-step speed command 1) and MI4 is set to 2 (multi-step speed command 2). Then the forward + second step speed command = $1001_2 = 9_{10}$.
- As long as Pr.02-12 = 9 is set through communications, there is no need to wire any multi-function terminal to run forward with the second step speed.

bit 4	bit 3	bit 2	bit 1	bit 0
MI5	MI4	MI3	MI2	MI1

📖 Use Pr.11-42 bit 1 to select whether the FWD / REV terminal is controlled by Pr.02-12 bit 0 and bit 1.

↗ **02-13** Multi-function Output 1 (Relay1)

Default: 11

↗ **02-16** Multi-function Output 2 (MO1)

Default: 0

- Settings
- 0: No function
 - 1: Indication during RUN
 - 2: Operation speed reached
 - 3: Desired frequency reached 1 (Pr.02-22)
 - 4: Desired frequency reached 2 (Pr.02-24)
 - 5: Zero speed (Frequency command)
 - 6: Zero speed, includes STOP (Frequency command)
 - 7: Over-torque 1 (Pr.06-06–06-08)
 - 8: Over-torque 2 (Pr.06-09–06-11)
 - 9: Drive is ready
 - 10: Low voltage warning (LV) (Pr.06-00)
 - 11: Malfunction indication
 - 13: Over-heat warning (Pr.06-15)
 - 14: Software brake signal indication (Pr.07-00)
 - 15: PID feedback error
 - 16: Slip error (oSL)
 - 17: Count value reached (Pr.02-20; does not return to 0)
 - 18: Count value reached (Pr.02-19; returns to 0)
 - 19: External interrupt B.B. input (Base Block)
 - 20: Warning output
 - 21: Over-voltage
 - 22: Over-current stall prevention
 - 23: Over-voltage stall prevention
 - 24: Operation source
 - 25: Forward command
 - 26: Reverse command
 - 29: Output when frequency \geq Pr.02-34
 - 30: Output when frequency $<$ Pr.02-34
 - 31: Y-connection for the motor coil
 - 32: Δ -connection for the motor coil
 - 33: Zero speed (actual output frequency)
 - 34: Zero speed include STOP (actual output frequency)
 - 35: Error output selection 1 (Pr.06-23)

- 36: Error output selection 2 (Pr.06-24)
- 37: Error output selection 3 (Pr.06-25)
- 38: Error output selection 4 (Pr.06-26)
- 40: Speed reached (including STOP)
- 42: Crane function
- 43: Motor speed slower than Pr.02-47
- 44: Low current output (use with Pr.06-71–Pr.06-73)
- 45: UVW output electromagnetic valve ON / OFF switch
- 46: Master dEb output
- 51: Output control for RS-485
- 66: SO output logic A (use with STO card)
- 67: Analog input level reached
- 68: SO output logic B (use with STO card)
- 69: Indication of Preheating
- 75: Forward RUN status
- 76: Reverse RUN status
- 77: Program Running Indication
- 78: Program Step Completed Indication
- 79: Program Running Completed Indication
- 80: Program Running Paused Indication

 Use this parameter to set the function of the multi-function terminals.

Summary of function settings

Take the normally open contact (N.O.) for example, ON: contact is closed, OFF: contact is open.

Settings	Functions	Descriptions
0	No Function	Output terminal with no function
1	Indication during RUN	Active when the drive is not in STOP.
2	Operation speed reached	Active when output frequency of the drive reaches the setting frequency.
3	Desired frequency reached 1 (Pr.02-22)	Active when the desired frequency (Pr.02-22) reached.
4	Desired frequency reached 2 (Pr.02-24)	Active when the desired frequency (Pr.02-24) reached.
5	Zero speed (Frequency command)	Active when frequency command = 0 (the drive must be in RUN status).
6	Zero speed, includes STOP (Frequency command)	Active when frequency command = 0 or stopped.
7	Over-torque 1	Active when the drive detects over-torque. Pr.06-07 sets the over-torque detection level (motor 1), and Pr.06-08 sets the over-torque detection time (motor 1). Refer to Pr.06-06–06-08.

Settings	Functions	Descriptions
8	Over-torque 2	Active when the drive detects over-torque. Pr.06-10 sets the over-torque detection level (motor 2), and Pr.06-11 sets the over-torque detection time (motor 2). Refer to Pr.06-09–06-11.
9	Drive is ready	Active when the drive is ON with no error detected.
10	Low voltage warn (LV)	Active when the DC BUS voltage is too low (refer to Pr.06-00 Low Voltage Level).
11	Malfunction indication	Active when fault occurs (except Lv stop).
13	Over-heat warning	Active when IGBT or heat sink overheats; to prevent the drive from shutting down due to over-heating (refer to Pr.06-15).
14	Software brake signal indication	Active when the soft brake function is ON (refer to Pr.07-00).
15	PID feedback error	Active when the PID feedback signal error is detected.
16	Slip error (oSL)	Active when the slip error is detected.
17	Count value reached (Pr.02-20)	When the drive executes external counter, this contact is active if the count value is equal to the setting value for Pr.02-20. This contact is not active when the setting value for Pr.02-20 > Pr.02-19.
18	Count value reached (Pr.02-19)	When the drive executes the external counter, this contact is active if the count value is equal to the setting value for Pr.02-19.
19	External interrupt B.B. input (Base Block)	Active when external interrupt (B.B.) stop output occurs in the drive.
20	Warning output	Active when a warning is detected.
21	Over-voltage	Active when over-voltage is detected.
22	Over-current stall prevention	Active when over-current stall prevention is detected.
23	Over-voltage stall prevention	Active when over-voltage stall prevention is detected.
24	Operation source	Active when the source of operation command is controlled by the digital keypad (Pr.00-21 = 0).
25	Forward command	Active when the operation direction is forward.
26	Reverse command	Active when the operation direction is reverse.
29	Output when frequency \geq Pr.02-34	Active when the frequency is \geq Pr.02-34 (actual output H \geq Pr.02-34).
30	Output when frequency < Pr.02-34	Active when frequency is < Pr.02-34 (actual output H < Pr.02-34).
31	Y-connection for the motor coil	Active when Pr.05-24 = 1, the frequency output is lower than Pr.05-23 minus 2 Hz, and the time is longer than Pr.05-25.

Settings	Functions	Descriptions
32	Δ -connection for the motor coil	Active when Pr.05-24 = 1, the frequency output is higher than Pr.05-23 plus 2 Hz, and the time is longer than Pr.05-25.
33	Zero speed (actual output frequency)	Active when the actual output frequency is 0 (the drive is in RUN mode).
34	Zero speed includes stop (actual output frequency)	Active when the actual output frequency is 0 or stopped.
35	Error output selection 1 (Pr.06-23)	Active when Pr.06-23 is ON.
36	Error output selection 2 (Pr.06-24)	Active when Pr.06-24 is ON.
37	Error Output Selection 3 (Pr.06-25)	Active when Pr.06-25 is ON.
38	Error Output Selection 4 (Pr.06-26)	Active when Pr.06-26 is ON.
40	Speed reached (including Stop)	Active when the output frequency reaches the setting frequency or stopped.
42	Crane function	Use this function with Pr.02-34 and Pr.02-58. Refer to Pr.02-34 and Pr.02-58 for details.
43	Motor speed output < Pr.02-47	Active when motor speed is less than Pr.02-47.
44	Low current output	Use this function with Pr.06-71–Pr.06-73.
45	UVW output electromagnetic valve ON / OFF switch	<p>Use this function with external terminal input = 49 (drive enabled) and external terminal output = 45 (electromagnetic valve enabled), and then the electromagnetic valve is ON or OFF according to the status of the drive.</p>
46	Master dEb output	When dEb rises at the master, MO sends a dEb signal to the slave. Output the message when the master triggers dEb. This ensures that the slave also triggers dEb. Then slave follows the deceleration time of the master to stop simultaneously with the master.

Settings	Functions	Descriptions														
51	Output control for RS-485	For RS-485 communication control output.														
66	SO output logic A (Use with STO card)	<table border="1"> <thead> <tr> <th rowspan="2">Status of the drive</th> <th colspan="2">Status of the safety output</th> </tr> <tr> <th>Status A (MO = 66)</th> <th>Status B (MO = 68)</th> </tr> </thead> <tbody> <tr> <td>Normal</td> <td>Broken circuit (open)</td> <td>Short circuit (closed)</td> </tr> <tr> <td>STO</td> <td>Short circuit (closed)</td> <td>Broken circuit (open)</td> </tr> <tr> <td>STL1–STL3</td> <td>Short circuit (closed)</td> <td>Broken circuit (open)</td> </tr> </tbody> </table>	Status of the drive	Status of the safety output		Status A (MO = 66)	Status B (MO = 68)	Normal	Broken circuit (open)	Short circuit (closed)	STO	Short circuit (closed)	Broken circuit (open)	STL1–STL3	Short circuit (closed)	Broken circuit (open)
		Status of the drive		Status of the safety output												
Status A (MO = 66)	Status B (MO = 68)															
Normal	Broken circuit (open)	Short circuit (closed)														
STO	Short circuit (closed)	Broken circuit (open)														
STL1–STL3	Short circuit (closed)	Broken circuit (open)														
68	SO output logic B (Use with STO card)															
67	Analog input level reached output	<p>The multi-function output terminals operate when the analog input level is between the high level and the low level.</p> <p>Pr.03-44: Select one of the analog input channels (AVI, ACI) to be compared.</p> <p>Pr.03-45: The high level for the analog input, default is 50%.</p> <p>Pr.03-46: The low level for the analog input, default is 10%.</p> <p>If analog input > Pr.03-45, the multi-function output terminal operates. If analog input < 03-46, the multi-function output terminal stops output.</p>														
69	Indication of Preheating	Active when preheating function is enabled.														
75	Forward RUN status	When the drive runs FWD, the output terminal status for forward running is closed; when the drive stops, the output terminal status for forward running is open.														
76	Reverse RUN status	When the drive runs REV, the output terminal status for reverse running is closed; when the drive stops, the output terminal status for reverse running is open.														
77	Program Running Indication	Closed when running program auto-run.														
78	Program Step Completed Indication	Closed for only 0.5 second whenever completing one step during program auto-run.														
79	Program Running Completed Indication	Closed for only 0.5 seconds when the program auto-run completes all steps.														
80	Program Running Paused Indication	Closed when the action of auto-run terminals are paused externally during program auto-run.														

02-18 Multi-function Output Direction

Default: 0000

Settings 0000h–FFFFh (0:N.O.; 1:N.C.)

- 📖 This parameter is in hexadecimal.
- 📖 This parameter is set by a bit. If the bit is 1, the corresponding multi-function output acts in an opposite way.

Example:

Assume Pr.02-13 = 1 (indication when the drive is operating). If the output is positive, the bit is set to 0, and then Relay is ON when the drive runs and is OFF when the drive stops. On the contrary, if the output is negative, and the bit is set to 1, then the Relay is OFF when the drive runs and is ON when the drive stops.

bit 3	bit 2	bit 1	bit 0
MO1	reserved	reserved	RY

02-19 Terminal Counting Value Reached (returns to 0)

Default: 0

Settings 0–65500

- 📖 This parameter uses the optional keypad KPC-CC01.
- You can set the input point for the counter using the multi-function terminal MI4 as a trigger terminal (set Pr.02-06 to 23). When counting is completed, the specified multi-function output terminal is activated (Pr.02-13 and Pr.02-16 is set to 18). Pr.02-19 cannot be set to 0 at this time.
- Example: When the displayed value is c5555, the drive count is 5,555. If the displayed value is c5555., the actual count value is 55,550–55,559.

02-20 Preliminary Counting Value Reached (does not return to 0)

Default: 0

Settings 0–65500

- 📖 This parameter uses the optional keypad KPC-CC01.
- 📖 When the count value counts from 1 to reach this value, the corresponding multi-function output terminal is activated (Pr.02-13 and Pr.02-16 is set to 17). You can use this parameter as the end of counting to make the drive run from the low speed to stop.

The timing diagram is shown below:

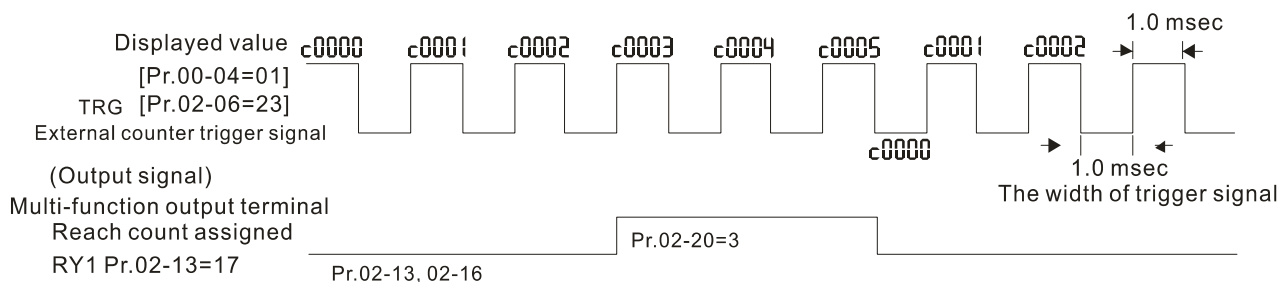

02-22 Desired Frequency Reached 1

Default: 60.00 / 50.00

Settings 0.00–599.00 Hz

02-23 Width of the Desired Frequency Reached 1

Default: 2.00

Settings 0.00–599.00 Hz

02-24 Desired Frequency Reached 2

Default: 60.00 / 50.00

Settings 0.00–599.00 Hz

02-25 Width of the Desired Frequency Reached 2

Default: 2.00

Settings 0.00–599.00 Hz

Once the output speed (frequency) reaches the desired speed (frequency), if the corresponding multi-function output terminal is set to 3–4 (Pr.02-13 and Pr.02-16), this multi-function output terminal is “closed”.

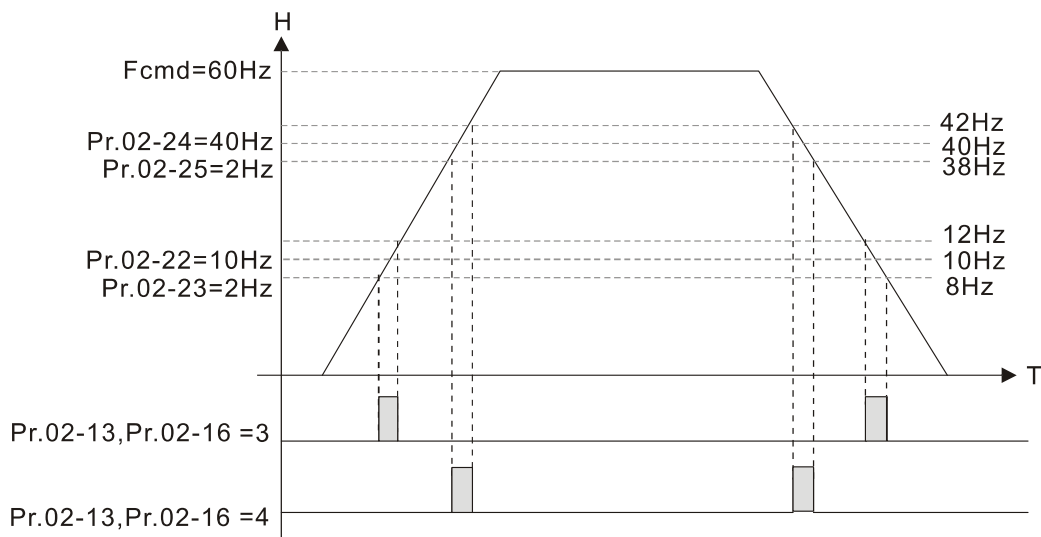

02-34 Output Frequency Setting for Multi-function Output Terminal

Default: 0.00

Settings 0.00–599.00 Hz

02-58 Multi-function Output Terminal: Function 42: Brake Frequency Check Point

Default: 0.00

Settings 0.00–599.00 Hz

- ☰ You can use Pr.02-34 with Pr.02-58 for the crane function. You can choose the crane action # 42 to set the multi-function outputs Pr.02-13 and Pr.02-16.
- ☰ When the output frequency of the drive is higher than the setting for Pr.02-34 frequency level (\geq Pr.02-34), choose # 42 to set the multi-function output terminal.
- ☰ When the output frequency is lower than the setting for Pr.02-58 ($<$ Pr.02-58), choose # 42 to disable the multi-function output terminal.

📖 Crane application example:

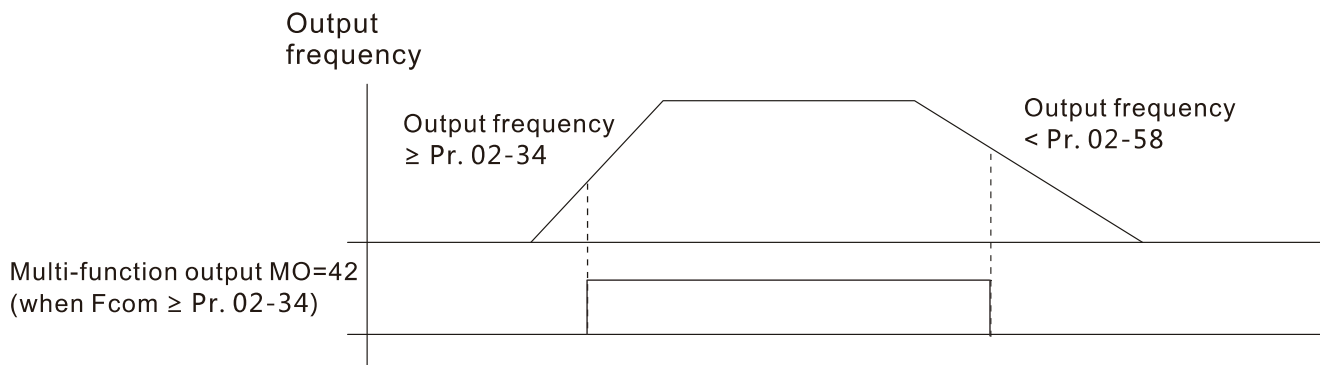

It is recommended that you use this with the Dwell function as shown in the following diagram:

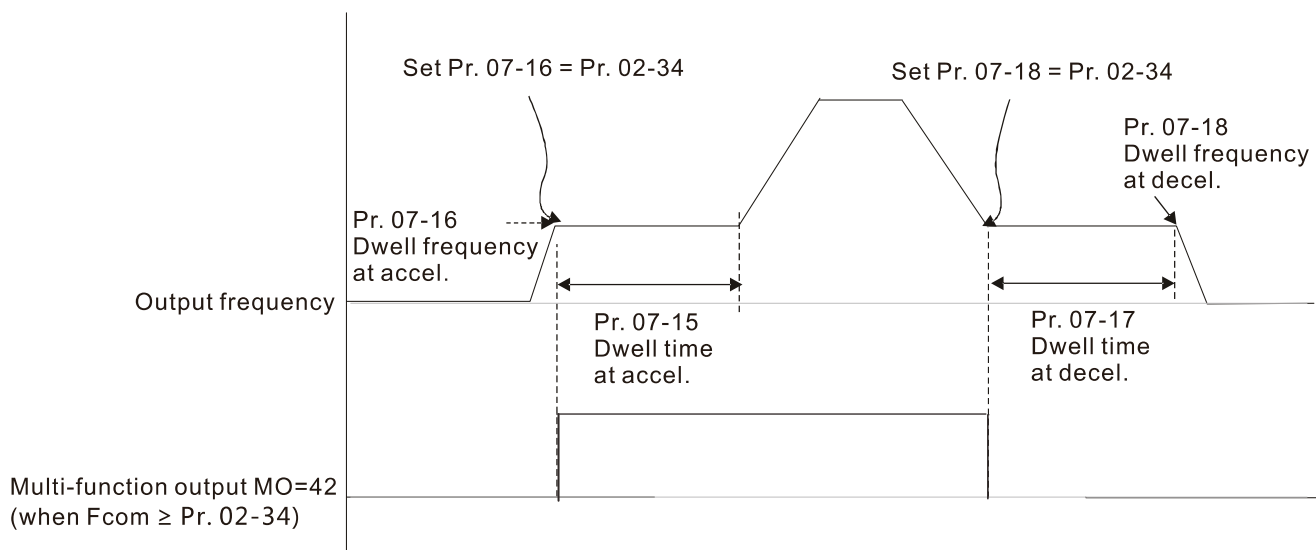

↗ **02-35** External Operation Control Selection after Reset and Activate

Default: 0

Settings 0: Disable

1: Drive runs if the RUN command remains after reset or reboot.

Set value as 1:

📖 Status 1: After the drive is powered on and the external terminal for RUN stays ON, the drive runs.

📖 Status 2: After clearing a fault once a fault is detected and the external terminal for RUN stays ON, you can run the drive by pressing the RESET key.

↗ **02-47** Motor Zero-speed Level

Default: 0

Settings 0–65535 rpm

📖 Use this parameter to set the level of motor at zero-speed. When the speed is lower than this setting, the corresponding multi-function output terminal that is set to 43 is ON, as shown below:

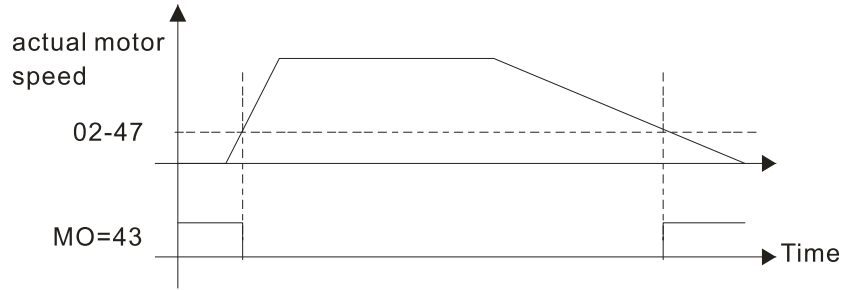

02-50 Display the Status of the Multi-function Input Terminal

Default: Read only

Settings Monitor the status of the Multi-function Input Terminal

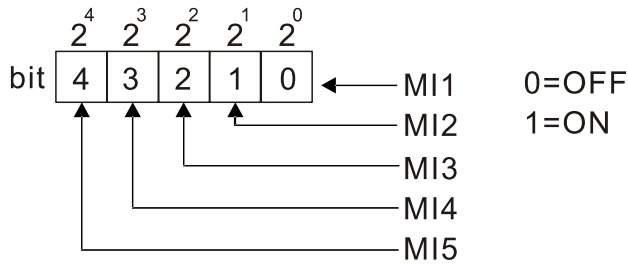

NOTE		
$2^4 = 16$	$2^3 = 8$	$2^2 = 4$
$2^1 = 2$	$2^0 = 1$	

Example:

When Pr.02-50 displays 0014h (hex) (that is, the value is 52 (decimal) and 10100 (binary)), it means that MI3 and MI5 are ON.

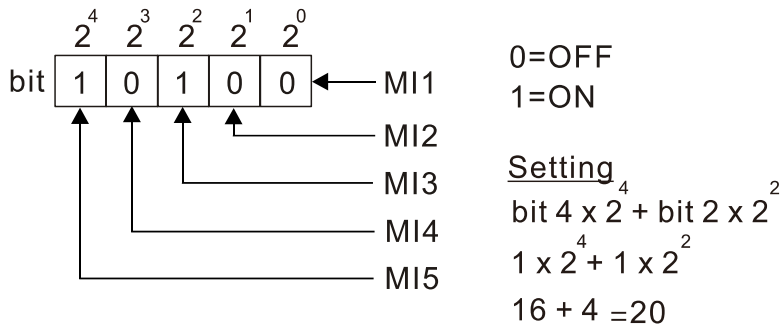

NOTE		
$2^4 = 16$	$2^3 = 8$	$2^2 = 4$
$2^1 = 2$	$2^0 = 1$	

02-51 Display the Status of the Multi-function Output Terminal

Default: Read only

Settings Monitor the status of the Multi-function Output Terminal

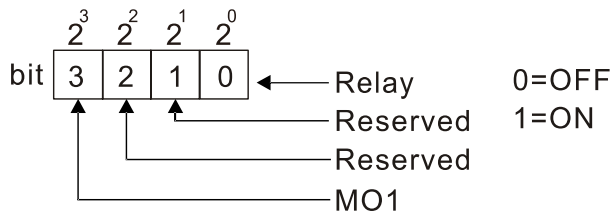

NOTE	
$2^3 = 8$	$2^2 = 4$
$2^1 = 2$	$2^0 = 1$

 Example:

When Pr.02-51 displays 0009h (hex) (that is, the value is 9 (decimal) and 01001 (binary)), it means that Relay and MO1 are ON.

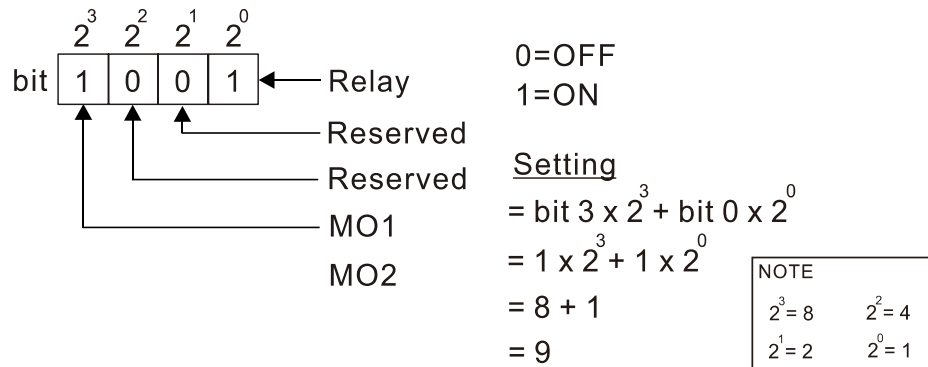

02-54 Display the Frequency Command Executed by the External Terminal

Default: Read only

Settings Read only

 When you set the source of the Frequency command as the external terminal, if Lv or Fault occurs, the external terminal Frequency command is saved in this parameter.

02-72 Level of Preheating DC Current

Default: 0

Settings 0–100 %

 This parameter controls the level of the preheating DC current input to the motor. The percentage of the preheating DC current equals to the percentage of motor rated current (Pr.05-01). Therefore, when you set this parameter, increase the level slowly to reach the desired preheating temperature.

 Related parameters: 02-73 Preheating DC Current Duty Cycle, 02-13 and 16 Multi-function Output Relay 69: Indication of Preheating Function, 02-01–05 Multi-function Input Terminal 69: Auto-activate preheating function.

02-73 Preheating DC Current Duty Cycle

Default: 0

Settings 0–100 %

 This parameter is to set up the duty cycle of the preheating DC current input to the motor. 0–100% corresponds to 0–10 sec. If the setting is 0%, there is no output current from the motor drive. If the setting is 100%, there is continuous output DC current. For example, when the setting of this parameter is 50%, the cycle time is the time spent to input current to motor for 5 seconds and stop inputting for 5 seconds. When MI #69 is enabled, this parameter operates periodically with MI#69 until the motor drive starts to run the motor or until MI#69 is disabled.

 Preheating function works only when the setting value for Pr.02-72 and Pr.02-73 are not 0.

 When MI=69 (auto-activate preheating function) is enabled, MI=69 controls the start and stop of preheating function.

 When MI=69 is DISABLED, the preheating function starts after:

The motor drive stops its first operation. The motor drive cycles the power.

The figure below shows the timing relationship when MI=69 auto-activate preheating function is enabled and when preheating DC current is enabled and cycle time is 50%.

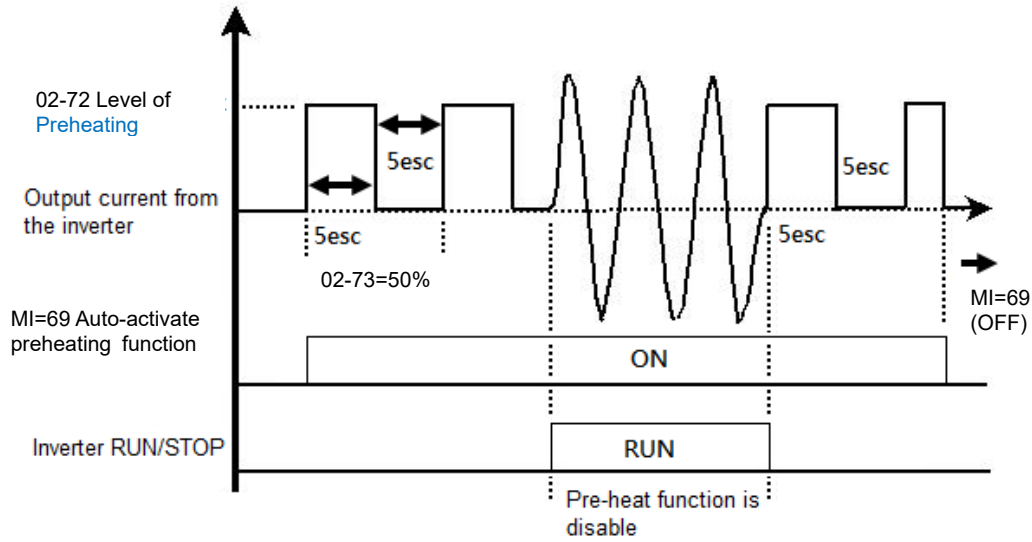

The figure below shows the timing relationship when MI=69 auto-activate preheating function is disabled and when preheating DC current is enabled and cycle time is 50%. When the motor drive is stopped, the preheating function starts to output DC current continuously.

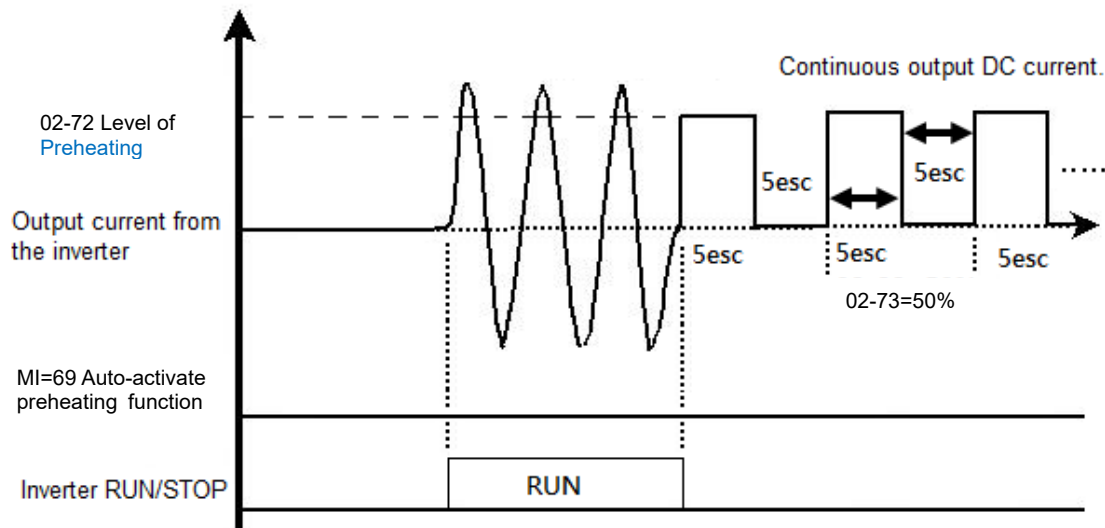

The figure below shows the timing relationship between preheating function and enabling DC brake.

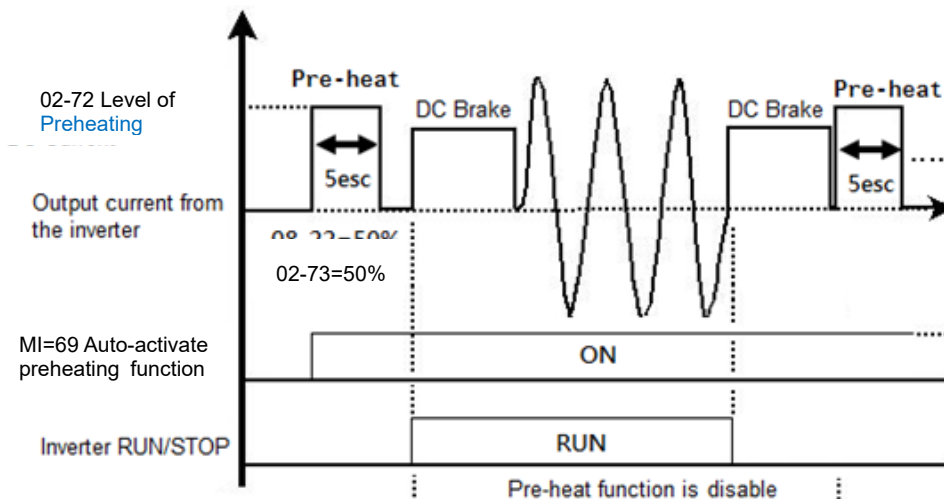

02-81 EF Active when the Terminal Count Value Reached

Default: 0

Settings 0: Terminal count value reached, no EF displays (continues to operate).
1: Terminal count value reached, EF is active.

02-82 Initial Frequency Command (F) Mode after Stop

Default: 0

Settings 0: Use current Frequency command
1: Use zero Frequency command
2: Refer to Pr.02-83 to set up

02-83 Initial Frequency Command (F) Setting after Stop

Default: 60.00

Settings 0.00–599.0 Hz

[This page intentionally left blank]

03 Analog Input / Output Parameters You can set this parameter during operation.

03-00 Analog Input Selection (AVI)

Default: 1

- Settings
- 0: No function
 - 1: Frequency command
 - 4: PID target value
 - 5: PID feedback signal
 - 6: PTC thermistor input value
 - 11: PT100 thermistor input value
 - 13: PID compensation value

 When you use analog input as the PID reference target input, you must set Pr.00-20 to 2 (external analog input).

Setting method 1: Pr.03-00 set 1 as PID reference target input.

Setting method 4: Pr.03-00 set 4 as PID reference target input.

 When you use analog input as the PID compensation value, you must set Pr.08-16 to 1 (source of PID compensation value is analog input). You can see the compensation value with Pr.08-17.

 When you use the frequency command, the corresponding value for 0– ±10 V / 4–20 mA is 0–maximum operation frequency (Pr.01-00).

03-03 Analog Input Bias (AVI)

Default: 0

- Settings -100.0–100.0%

 Sets the corresponding AVI voltage for the external analog input 0.

03-04 Analog Input Bias (ACI)

Default: 0

- Settings -100.0–100.0%

 Sets the corresponding ACI voltage for the external analog input 0.

03-07 Positive / Negative Bias Mode (AVI)

03-08 Positive / Negative Bias Mode (ACI)

Default: 0

- Settings
- 0: No bias
 - 1: Lower than or equal to bias
 - 2: Greater than or equal to bias
 - 3: The absolute value of the bias voltage while serving as the center
 - 4: Bias serves as the center

 In a noisy environment, use negative bias to provide a noise margin. Do NOT use less than 1 V to set the operation frequency.

03-10 Reverse Setting when Analog Signal Input is Negative Frequency

Default: 0

- Settings
- 0: Negative frequency input is not allowed. The digital keypad or external terminal controls the forward and reverse direction.
 - 1: Negative frequency input is allowed. Positive frequency = run in forward direction; negative frequency = run in reverse direction. The digital keypad or external terminal control cannot switch the running direction.

Use Pr.03-10 to enable running in the reverse direction command when a negative frequency (negative bias and gain) is input to the AVI or ACI analog signal input.

Condition for negative frequency (reverse)

1. Pr.03-10 = 1
2. Bias mode = Bias serves as the center
3. Corresponded analog input gain < 0 (negative); this makes the input frequency negative.

In the diagram below: **Black line: Curve with no bias. Gray line: curve with bias**

Diagram 01

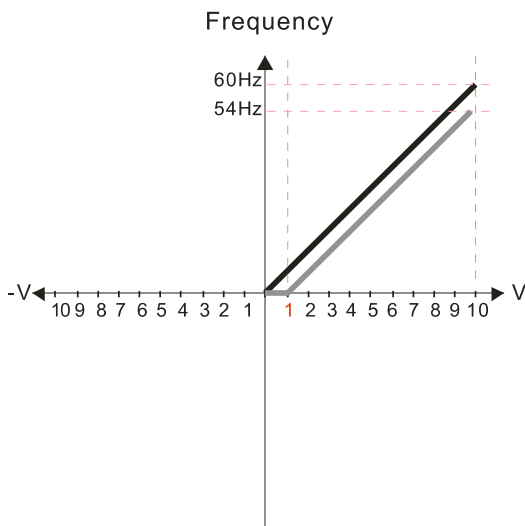

Pr.03-03=10%
Pr.03-07-03-08 (Positive/Negative Bias Mode)

- 0: No bias
- 1: Lower than or equal bias
- 2: Greater than or equal to bias
- 3: The absolute value of the bias voltage while serving as the center
- 4: Bias serves as the center

Pr.03-10 (Analog Frequency Command for Reverse Run)

- 0: Negative frequency is not valid. Forward and reverse run is controlled by digital keyboard or external terminals.
- 1: Negative frequency is valid. Positive frequency = forward run; negative frequency = reverse run. Direction can not be switched by digital keypad or external terminal control.

Pr.03-11 Analog input Gain (AVI) = 100%

Diagram 02

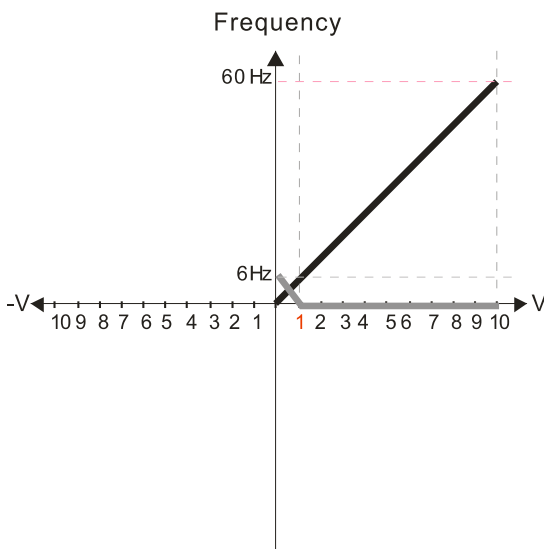

Pr.03-03=10%
Pr.03-07-03-08 (Positive/Negative Bias Mode)

- 0: No bias
- 1: Lower than or equal bias
- 2: Greater than or equal to bias
- 3: The absolute value of the bias voltage while serving as the center
- 4: Bias serves as the center

Pr.03-10 (Analog Frequency Command for Reverse Run)

- 0: Negative frequency is not valid. Forward and reverse run is controlled by digital keyboard or external terminals.
- 1: Negative frequency is valid. Positive frequency = forward run; negative frequency = reverse run. Direction can not be switched by digital keypad or external terminal control.

Pr.03-11 Analog input Gain (AVI) = 100%

Diagram 03

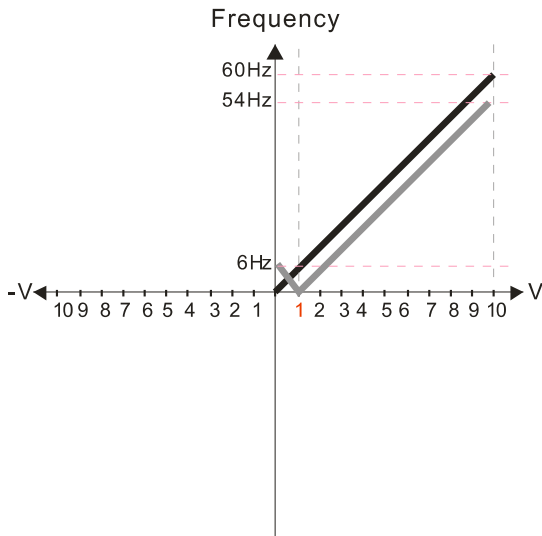

Pr.03-03=10%
Pr.03-07-03-08 (Positive/Negative Bias Mode)

- 0: No bias
- 1: Lower than or equal bias
- 2: Greater than or equal to bias
- 3: The absolute value of the bias voltage while serving as the center
- 4: Bias serves as the center

Pr.03-10 (Analog Frequency Command for Reverse Run)

- 0: Negative frequency is not valid. Forward and reverse run is controlled by digital keyboard or external terminals.
- 1: Negative frequency is valid. Positive frequency = forward run; negative frequency = reverse run. Direction can not be switched by digital keypad or external terminal control.

Pr.03-11 Analog input Gain (AVI) = 100%

Diagram 04

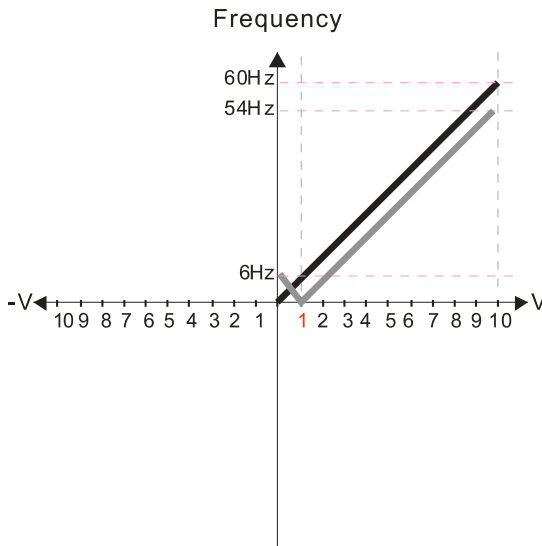

Pr.03-03=10%
Pr.03-07-03-08 (Positive/Negative Bias Mode)

- 0: No bias
- 1: Lower than or equal bias
- 2: Greater than or equal to bias
- 3: The absolute value of the bias voltage while serving as the center
- 4: Bias serves as the center

Pr.03-10 (Analog Frequency Command for Reverse Run)

- 0: Negative frequency is not valid. Forward and reverse run is controlled by digital keyboard or external terminals.
- 1: Negative frequency is valid. Positive frequency = forward run; negative frequency = reverse run. Direction can not be switched by digital keypad or external terminal control.

Pr.03-11 Analog input Gain (AVI) = 100%

Diagram 05

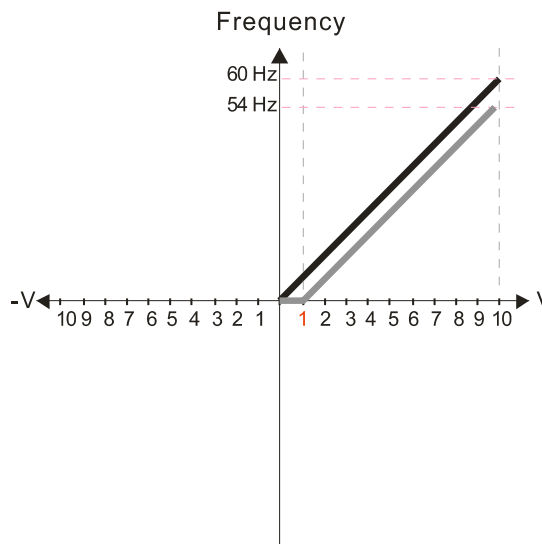

Pr.03-03=10%
Pr.03-07-03-08 (Positive/Negative Bias Mode)

- 0: No bias
- 1: Lower than or equal bias
- 2: Greater than or equal to bias
- 3: The absolute value of the bias voltage while serving as the center
- 4: Bias serves as the center

Pr.03-10 (Analog Frequency Command for Reverse Run)

- 0: Negative frequency is not valid. Forward and reverse run is controlled by digital keyboard or external terminals.
- 1: Negative frequency is valid. Positive frequency = forward run; negative frequency = reverse run. Direction can not be switched by digital keypad or external terminal control.

Pr.03-11 Analog input Gain (AVI) = 100%

Diagram 06

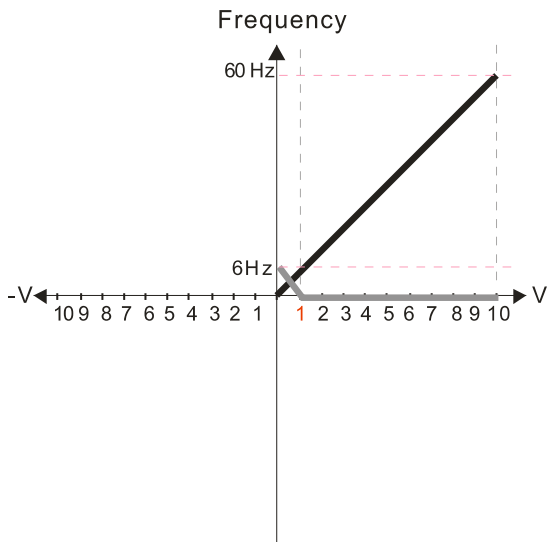

Pr.03-03=10%
Pr.03-07-03-08 (Positive/Negative Bias Mode)

- 0: No bias
- 1: Lower than or equal bias
- 2: Greater than or equal to bias
- 3: The absolute value of the bias voltage while serving as the center
- 4: Bias serves as the center

Pr.03-10 (Analog Frequency Command for Reverse Run)

- 0: Negative frequency is not valid. Forward and reverse run is controlled by digital keyboard or external terminals.
- 1: Negative frequency is valid. Positive frequency = forward run; negative frequency = reverse run. Direction can not be switched by digital keypad or external terminal control.

Pr.03-11 Analog input Gain (AVI) = 100%

Diagram 07

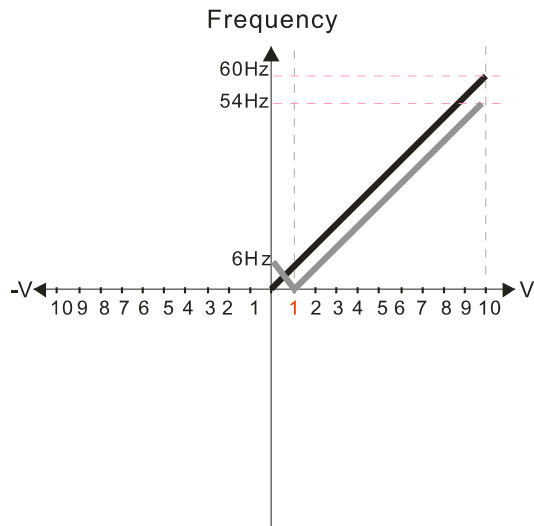

Pr.03-03=10%
Pr.03-07-03-08 (Positive/Negative Bias Mode)

- 0: No bias
- 1: Lower than or equal bias
- 2: Greater than or equal to bias
- 3: The absolute value of the bias voltage while serving as the center
- 4: Bias serves as the center

Pr.03-10 (Analog Frequency Command for Reverse Run)

- 0: Negative frequency is not valid. Forward and reverse run is controlled by digital keyboard or external terminals.
- 1: Negative frequency is valid. Positive frequency = forward run; negative frequency = reverse run. Direction can not be switched by digital keypad or external terminal control.

Pr.03-11 Analog input Gain (AVI) = 100%

Diagram 08

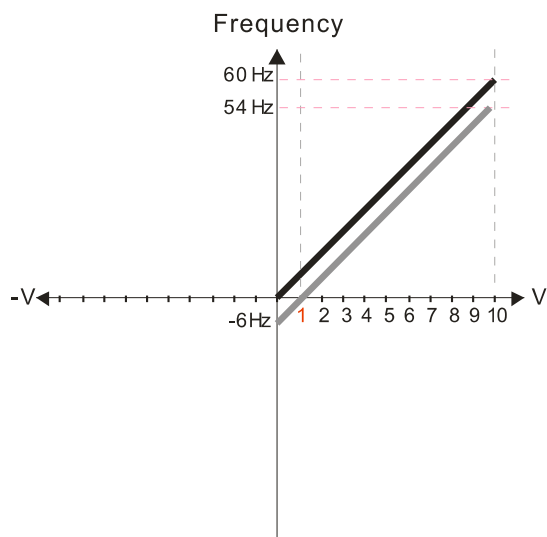

Pr.03-03=10%
Pr.03-07-03-08 (Positive/Negative Bias Mode)

- 0: No bias
- 1: Lower than or equal bias
- 2: Greater than or equal to bias
- 3: The absolute value of the bias voltage while serving as the center
- 4: Bias serves as the center

Pr.03-10 (Analog Frequency Command for Reverse Run)

- 0: Negative frequency is not valid. Forward and reverse run is controlled by digital keyboard or external terminals.
- 1: Negative frequency is valid. Positive frequency = forward run; negative frequency = reverse run. Direction can not be switched by digital keypad or external terminal control.

Pr.03-11 Analog input Gain (AVI) = 100%

Diagram 09

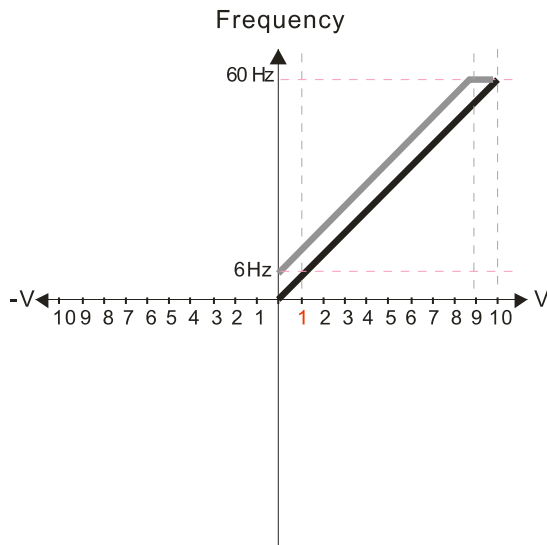

Pr.03-03=-10%
Pr.03-07-03-08 (Positive/Negative Bias Mode)

- 0: No bias
- 1: Lower than or equal bias
- 2: Greater than or equal to bias
- 3: The absolute value of the bias voltage while serving as the center
- 4: Bias serves as the center

Pr.03-10 (Analog Frequency Command for Reverse Run)

- 0: Negative frequency is not valid. Forward and reverse run is controlled by digital keyboard or external terminals.
- 1: Negative frequency is valid. Positive frequency = forward run; negative frequency = reverse run. Direction can not be switched by digital keypad or external terminal control.

Pr.03-11 Analog input Gain (AVI) = 100%

Diagram 10

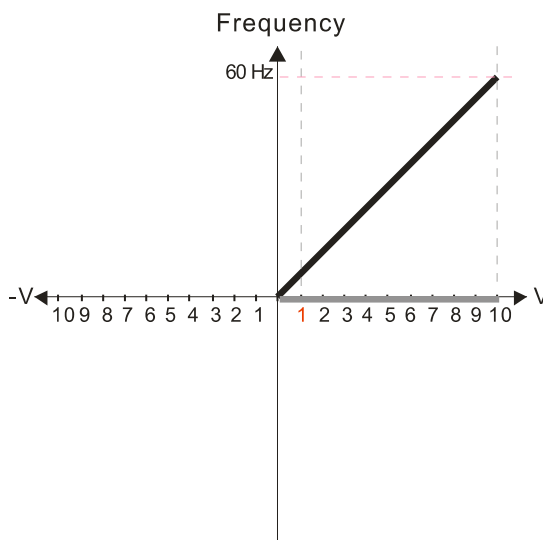

Pr.03-03=-10%
Pr.03-07-03-08 (Positive/Negative Bias Mode)

- 0: No bias
- 1: Lower than or equal bias
- 2: Greater than or equal to bias
- 3: The absolute value of the bias voltage while serving as the center
- 4: Bias serves as the center

Pr.03-10 (Analog Frequency Command for Reverse Run)

- 0: Negative frequency is not valid. Forward and reverse run is controlled by digital keyboard or external terminals.
- 1: Negative frequency is valid. Positive frequency = forward run; negative frequency = reverse run. Direction can not be switched by digital keypad or external terminal control.

Pr.03-11 Analog input Gain (AVI) = 100%

Diagram 11

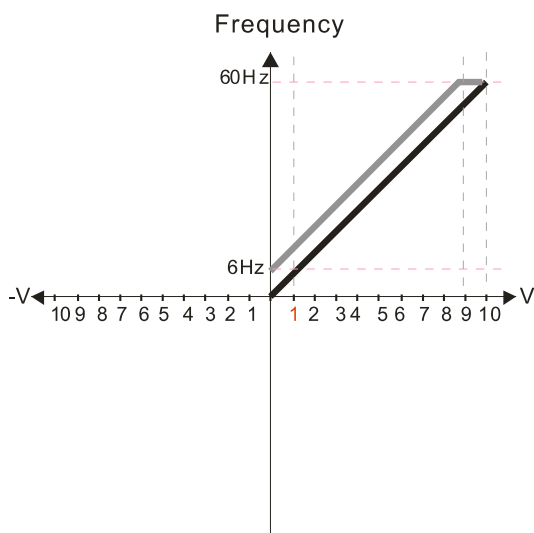

Pr.03-03=-10%
Pr.03-07-03-08 (Positive/Negative Bias Mode)

- 0: No bias
- 1: Lower than or equal bias
- 2: Greater than or equal to bias
- 3: The absolute value of the bias voltage while serving as the center
- 4: Bias serves as the center

Pr.03-10 (Analog Frequency Command for Reverse Run)

- 0: Negative frequency is not valid. Forward and reverse run is controlled by digital keyboard or external terminals.
- 1: Negative frequency is valid. Positive frequency = forward run; negative frequency = reverse run. Direction can not be switched by digital keypad or external terminal control.

Pr.03-11 Analog input Gain (AVI) = 100%

Diagram 12

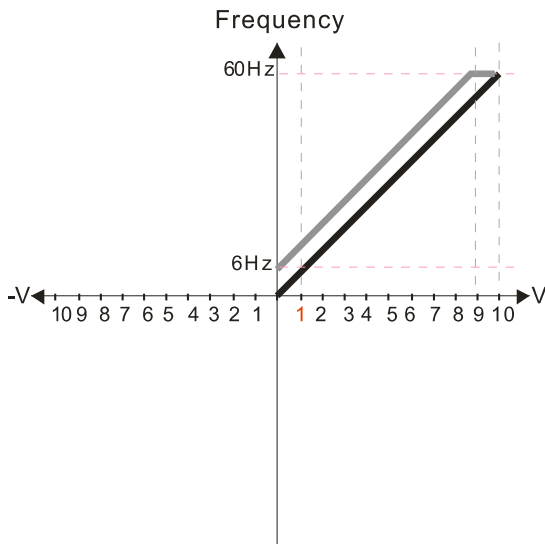

Pr.03-03=-10%
Pr.03-07-03-08 (Positive/Negative Bias Mode)

- 0: No bias
- 1: Lower than or equal bias
- 2: Greater than or equal to bias
- 3: The absolute value of the bias voltage while serving as the center
- 4: Bias serves as the center

Pr.03-10 (Analog Frequency Command for Reverse Run)

- 0: Negative frequency is not valid. Forward and reverse run is controlled by digital keyboard or external terminals.
- 1: Negative frequency is valid. Positive frequency = forward run; negative frequency = reverse run. Direction can not be switched by digital keypad or external terminal control.

Pr.03-11 Analog input Gain (AVI) = 100%

Diagram 13

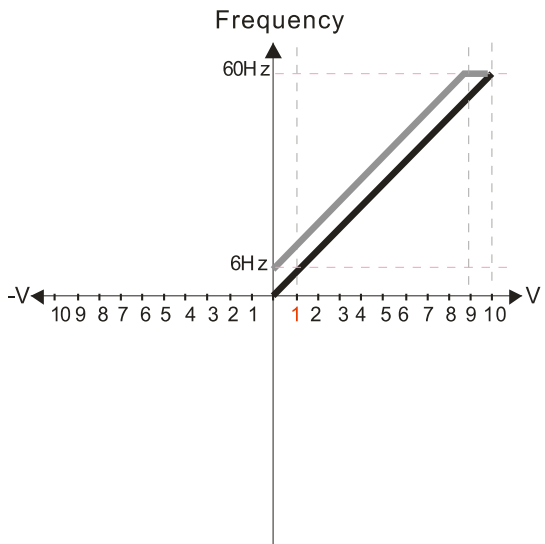

Pr.03-03=-10%
Pr.03-07-03-08 (Positive/Negative Bias Mode)

- 0: No bias
- 1: Lower than or equal bias
- 2: Greater than or equal to bias
- 3: The absolute value of the bias voltage while serving as the center
- 4: Bias serves as the center

Pr.03-10 (Analog Frequency Command for Reverse Run)

- 0: Negative frequency is not valid. Forward and reverse run is controlled by digital keyboard or external terminals.
- 1: Negative frequency is valid. Positive frequency = forward run; negative frequency = reverse run. Direction can not be switched by digital keypad or external terminal control.

Pr.03-11 Analog input Gain (AVI) = 100%

Diagram 14

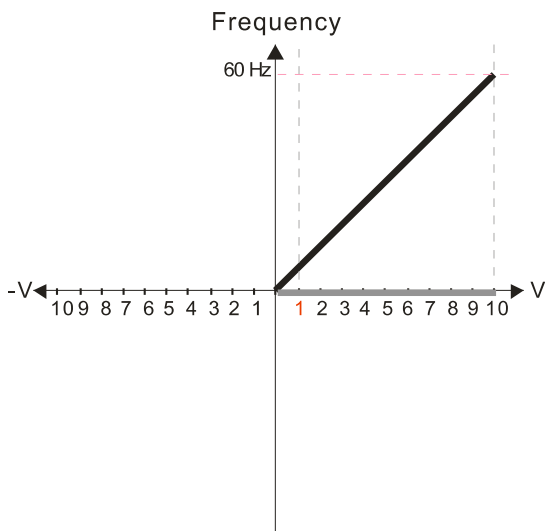

Pr.03-03=-10%
Pr.03-07-03-08 (Positive/Negative Bias Mode)

- 0: No bias
- 1: Lower than or equal bias
- 2: Greater than or equal to bias
- 3: The absolute value of the bias voltage while serving as the center
- 4: Bias serves as the center

Pr.03-10 (Analog Frequency Command for Reverse Run)

- 0: Negative frequency is not valid. Forward and reverse run is controlled by digital keyboard or external terminals.
- 1: Negative frequency is valid. Positive frequency = forward run; negative frequency = reverse run. Direction can not be switched by digital keypad or external terminal control.

Pr.03-11 Analog input Gain (AVI) = 100%

Diagram 15

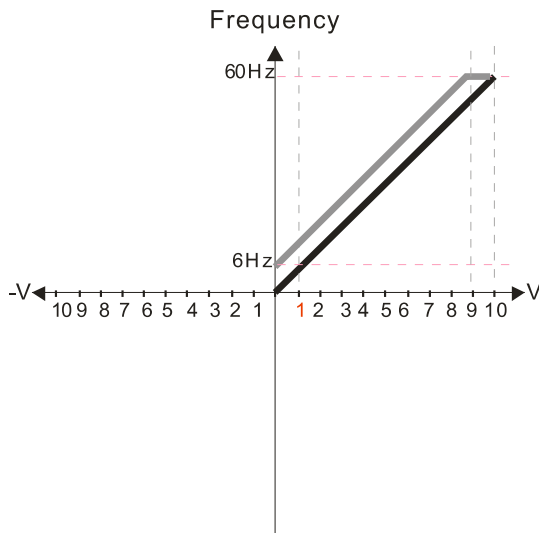

Pr.03-03=-10%
Pr.03-07-03-08 (Positive/Negative Bias Mode)

- 0: No bias
- 1: Lower than or equal bias
- 2: Greater than or equal to bias
- 3: The absolute value of the bias voltage while serving as the center
- 4: Bias serves as the center

Pr.03-10 (Analog Frequency Command for Reverse Run)

- 0: Negative frequency is not valid. Forward and reverse run is controlled by digital keyboard or external terminals.
- 1: Negative frequency is valid. Positive frequency = forward run; negative frequency = reverse run. Direction can not be switched by digital keypad or external terminal control.

Pr.03-11 Analog input Gain (AVI) = 100%

Diagram 16

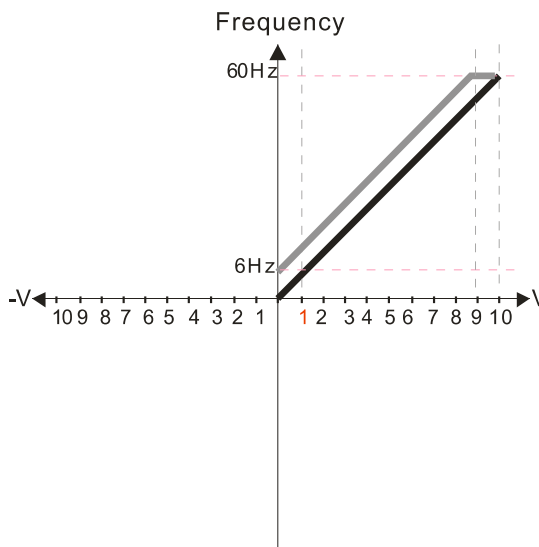

Pr.03-03=-10%
Pr.03-07-03-08 (Positive/Negative Bias Mode)

- 0: No bias
- 1: Lower than or equal bias
- 2: Greater than or equal to bias
- 3: The absolute value of the bias voltage while serving as the center
- 4: Bias serves as the center

Pr.03-10 (Analog Frequency Command for Reverse Run)

- 0: Negative frequency is not valid. Forward and reverse run is controlled by digital keyboard or external terminals.
- 1: Negative frequency is valid. Positive frequency = forward run; negative frequency = reverse run. Direction can not be switched by digital keypad or external terminal control.

Pr.03-11 Analog input Gain (AVI) = 100%

Diagram 17

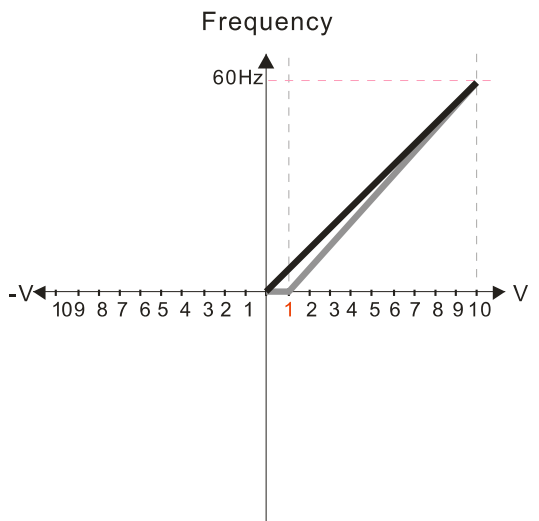

Pr.03-03=10%
Pr.03-07-03-08 (Positive/Negative Bias Mode)

- 0: No bias
- 1: Lower than or equal bias
- 2: Greater than or equal to bias
- 3: The absolute value of the bias voltage while serving as the center
- 4: Bias serves as the center

Pr.03-10 (Analog Frequency Command for Reverse Run)

- 0: Negative frequency is not valid. Forward and reverse run is controlled by digital keyboard or external terminals.
- 1: Negative frequency is valid. Positive frequency = forward run; negative frequency = reverse run. Direction can not be switched by digital keypad or external terminal control.

Pr.03-11 Analog input Gain (AVI) = 111.1%
10/9 = 111.1%

Diagram 18

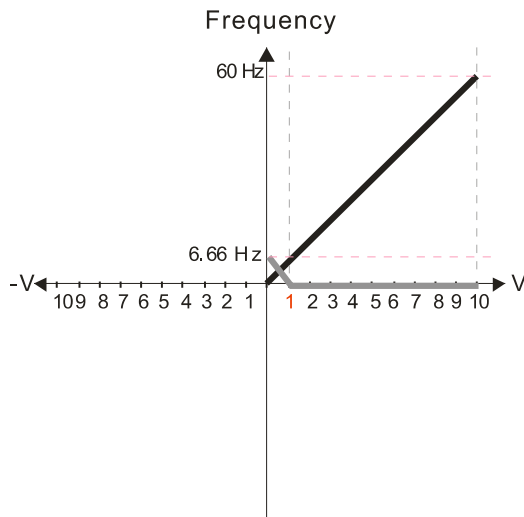

Pr.03-03=10%
Pr.03-07-03-08 (Positive/Negative Bias Mode)

- 0: No bias
- 1: Lower than or equal bias
- 2: Greater than or equal to bias
- 3: The absolute value of the bias voltage while serving as the center
- 4: Bias serves as the center

Pr.03-10 (Analog Frequency Command for Reverse Run)

- 0: Negative frequency is not valid. Forward and reverse run is controlled by digital keyboard or external terminals.
- 1: Negative frequency is valid. Positive frequency = forward run; negative frequency = reverse run. Direction can not be switched by digital keypad or external terminal control.

Pr.03-11 Analog input Gain (AVI) = 111.1%
10/9 = 111.1%

Diagram 19

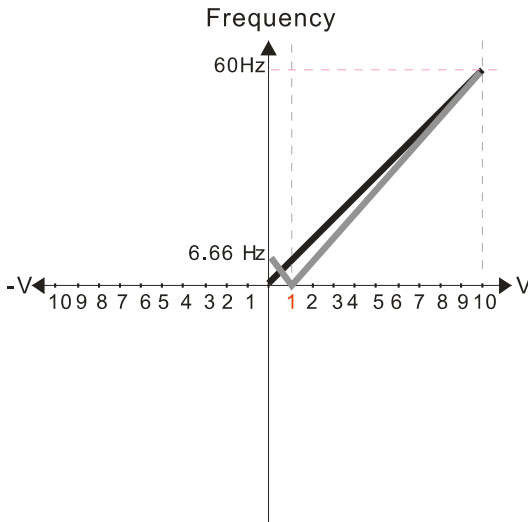

Pr.03-03=10%
Pr.03-07-03-08 (Positive/Negative Bias Mode)

- 0: No bias
- 1: Lower than or equal bias
- 2: Greater than or equal to bias
- 3: The absolute value of the bias voltage while serving as the center
- 4: Bias serves as the center

Pr.03-10 (Analog Frequency Command for Reverse Run)

- 0: Negative frequency is not valid. Forward and reverse run is controlled by digital keyboard or external terminals.
- 1: Negative frequency is valid. Positive frequency = forward run; negative frequency = reverse run. Direction can not be switched by digital keypad or external terminal control.

Pr.03-11 Analog input Gain (AVI) = 111.1%
10/9 = 111.1%

Diagram 20

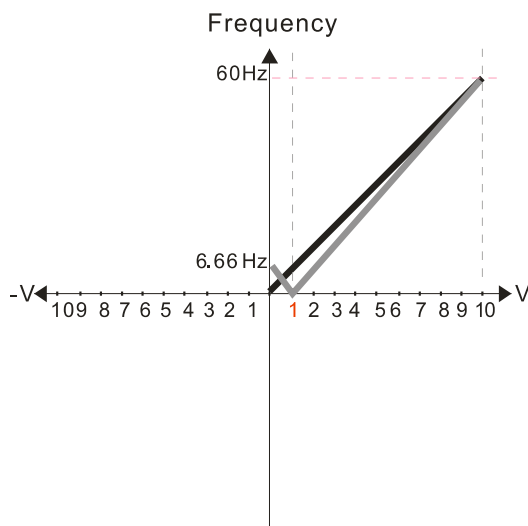

Pr.03-03=10%
Pr.03-07-03-08 (Positive/Negative Bias Mode)

- 0: No bias
- 1: Lower than or equal bias
- 2: Greater than or equal to bias
- 3: The absolute value of the bias voltage while serving as the center
- 4: Bias serves as the center

Pr.03-10 (Analog Frequency Command for Reverse Run)

- 0: Negative frequency is not valid. Forward and reverse run is controlled by digital keyboard or external terminals.
- 1: Negative frequency is valid. Positive frequency = forward run; negative frequency = reverse run. Direction can not be switched by digital keypad or external terminal control.

Pr.03-11 Analog input Gain (AVI) = 111.1%
10/9 = 111.1%

Diagram 24

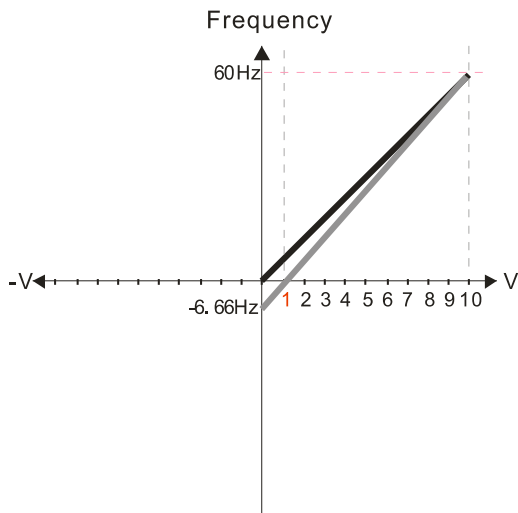

Pr.03-03=10%
Pr.03-07-03-08 (Positive/Negative Bias Mode)

- 0: No bias
- 1: Lower than or equal bias
- 2: Greater than or equal to bias
- 3: The absolute value of the bias voltage while serving as the center
- 4: Bias serves as the center

Pr.03-10 (Analog Frequency Command for Reverse Run)

- 0: Negative frequency is not valid. Forward and reverse run is controlled by digital keyboard or external terminals.
- 1: Negative frequency is valid. Positive frequency = forward run; negative frequency = reverse run. Direction can not be switched by digital keypad or external terminal control.

Pr.03-11 Analog input Gain (AVI) = 111.1%
 $10/9 = 111.1\%$

Diagram 25

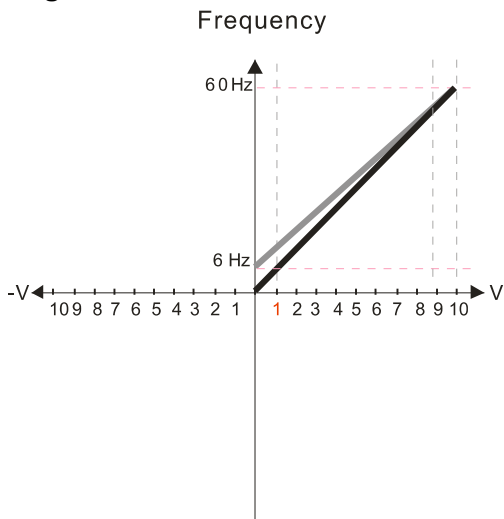

Pr.03-07-03-08 (Positive/Negative Bias Mode)

- 0: No bias
- 1: Lower than or equal bias
- 2: Greater than or equal to bias
- 3: The absolute value of the bias voltage while serving as the center
- 4: Bias serves as the center

Pr.03-10 (Analog Frequency Command for Reverse Run)

- 0: Negative frequency is not valid. Forward and reverse run is controlled by digital keyboard or external terminals.
- 1: Negative frequency is valid. Positive frequency = forward run; negative frequency = reverse run. Direction can not be switched by digital keypad or external terminal control.

Calculate the bias:

$$\frac{60-6\text{Hz}}{10\text{V}} = \frac{6-0\text{Hz}}{(0-X)\text{V}} \quad X\text{V} = \frac{100}{-9} = -1.11\text{V} \quad \therefore 03-03 = \frac{-1.11}{10} \times 100\% = -11.1\%$$

Calculate the gain:

$$\text{Pr.03-11} = \frac{10\text{V}}{11.1\text{V}} \times 100\% = 90.0\%$$

Diagram 26

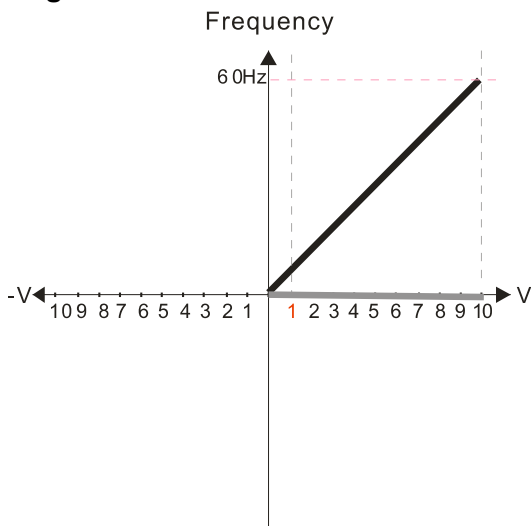

Pr.03-07-03-08 (Positive/Negative Bias Mode)

- 0: No bias
- 1: Lower than or equal bias
- 2: Greater than or equal to bias
- 3: The absolute value of the bias voltage while serving as the center
- 4: Bias serves as the center

Pr.03-10 (Analog Frequency Command for Reverse Run)

- 0: Negative frequency is not valid. Forward and reverse run is controlled by digital keyboard or external terminals.
- 1: Negative frequency is valid. Positive frequency = forward run; negative frequency = reverse run. Direction can not be switched by digital keypad or external terminal control.

Diagram 27

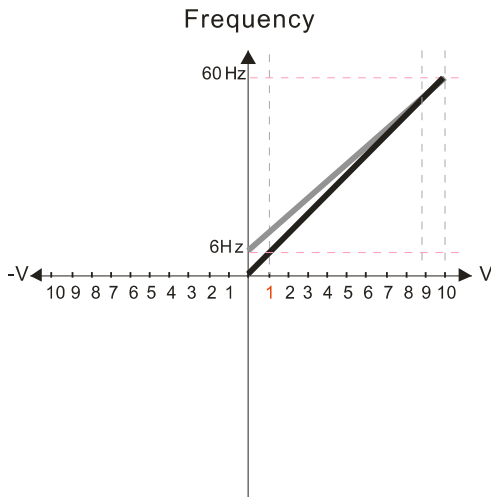

Pr.03-07-03-08 (Positive/Negative Bias Mode)

- 0: No bias
- 1: Lower than or equal bias
- 2: Greater than or equal to bias
- 3: The absolute value of the bias voltage while serving as the center
- 4: Bias serves as the center

Pr.03-10 (Analog Frequency Command for Reverse Run)

- 0: Negative frequency is not valid. Forward and reverse run is controlled by digital keyboard or external terminals.
- 1: Negative frequency is valid. Positive frequency = forward run; negative frequency = reverse run. Direction can not be switched by digital keypad or external terminal control.

Calculate the bias:

$$\frac{60-6\text{Hz}}{10\text{V}} = \frac{6-0\text{Hz}}{(0-X)\text{V}} \quad X\text{V} = \frac{100}{-9} = -1.11\text{V} \quad \therefore .03-03 = \frac{-1.11}{10} \times 100\% = -11.1\%$$

Calculate the gain:

$$\text{Pr.03-11} = \frac{10\text{V}}{11.1\text{V}} \times 100\% = 90.0\%$$

Diagram 28

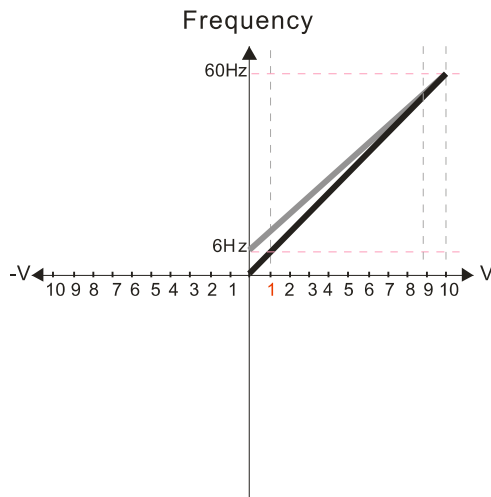

Pr.03-07-03-08 (Positive/Negative Bias Mode)

- 0: No bias
- 1: Lower than or equal bias
- 2: Greater than or equal to bias
- 3: The absolute value of the bias voltage while serving as the center
- 4: Bias serves as the center

Pr.03-10 (Analog Frequency Command for Reverse Run)

- 0: Negative frequency is not valid. Forward and reverse run is controlled by digital keyboard or external terminals.
- 1: Negative frequency is valid. Positive frequency = forward run; negative frequency = reverse run. Direction can not be switched by digital keypad or external terminal control.

Calculate the bias:

$$\frac{60-6\text{Hz}}{10\text{V}} = \frac{6-0\text{Hz}}{(0-X)\text{V}} \quad X\text{V} = \frac{100}{-9} = -1.11\text{V} \quad \therefore .03-03 = \frac{-1.11}{10} \times 100\% = -11.1\%$$

Calculate the gain:

$$\text{Pr.03-11} = \frac{10\text{V}}{11.1\text{V}} \times 100\% = 90.0\%$$

Diagram 29

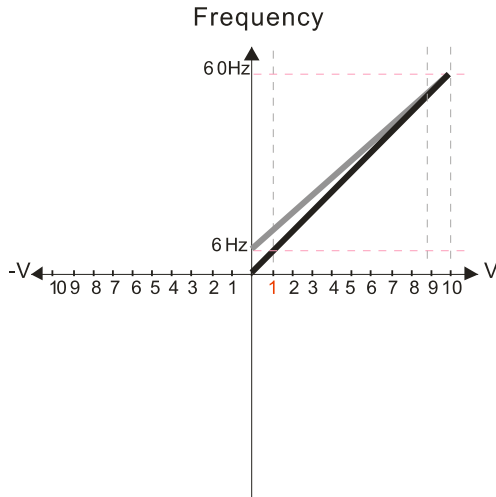

Pr.03-07-03-08 (Positive/Negative Bias Mode)

- 0: No bias
- 1: Lower than or equal bias
- 2: Greater than or equal to bias
- 3: The absolute value of the bias voltage while serving as the center
- 4: Bias serves as the center

Pr.03-10 (Analog Frequency Command for Reverse Run)

- 0: Negative frequency is not valid. Forward and reverse run is controlled by digital keyboard or external terminals.
- 1: Negative frequency is valid. Positive frequency = forward run; negative frequency = reverse run. Direction can not be switched by digital keypad or external terminal control.

Calculate the bias:

$$\frac{60-6\text{Hz}}{10\text{V}} = \frac{6-0\text{Hz}}{(0-X\text{V})} \quad X\text{V} = \frac{100}{-9} = -1.11\text{V} \quad \therefore 03-03 = \frac{-1.11}{10} \times 100\% = -11.1\%$$

Calculate the gain:

$$\text{Pr.03-11} = \frac{10\text{V}}{11.1\text{V}} \times 100\% = 90.0\%$$

Diagram 30

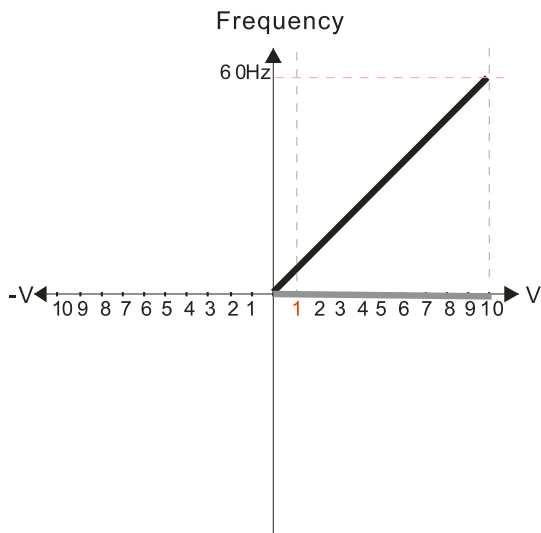

Pr.03-07-03-08 (Positive/Negative Bias Mode)

- 0: No bias
- 1: Lower than or equal bias
- 2: Greater than or equal to bias
- 3: The absolute value of the bias voltage while serving as the center
- 4: Bias serves as the center

Pr.03-10 (Analog Frequency Command for Reverse Run)

- 0: Negative frequency is not valid. Forward and reverse run is controlled by digital keyboard or external terminals.
- 1: Negative frequency is valid. Positive frequency = forward run; negative frequency = reverse run. Direction can not be switched by digital keypad or external terminal control.

Diagram 31

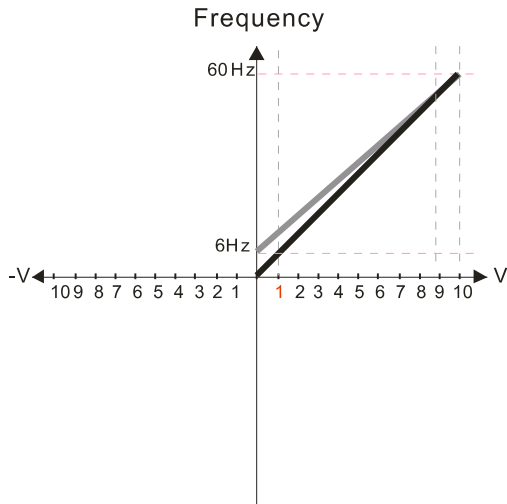

Pr.03-07-03-08 (Positive/Negative Bias Mode)

- 0: No bias
- 1: Lower than or equal bias
- 2: Greater than or equal to bias
- 3: The absolute value of the bias voltage while serving as the center
- 4: Bias serves as the center

Pr.03-10 (Analog Frequency Command for Reverse Run)

- 0: Negative frequency is not valid. Forward and reverse run is controlled by digital keyboard or external terminals.
- 1: Negative frequency is valid. Positive frequency = forward run; negative frequency = reverse run. Direction can not be switched by digital keypad or external terminal control.

Calculate the bias:

$$\frac{60-6\text{Hz}}{10\text{V}} = \frac{6-0\text{Hz}}{(0-X\text{V})} \quad X\text{V} = \frac{100}{-9} = -1.11\text{V} \quad \therefore 03-03 = \frac{-1.11}{10} \times 100\% = -11.1\%$$

Calculate the gain:

$$\text{Pr.03-11} = \frac{10\text{V}}{11.1\text{V}} \times 100\% = 90.0\%$$

Diagram 32

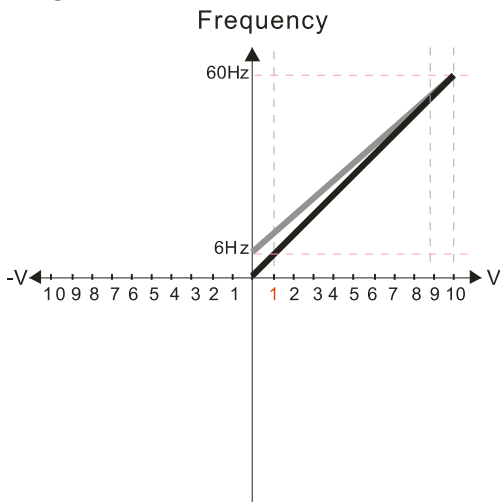

Pr.03-07-03-08 (Positive/Negative Bias Mode)

- 0: No bias
- 1: Lower than or equal bias
- 2: Greater than or equal to bias
- 3: The absolute value of the bias voltage while serving as the center
- 4: Bias serves as the center

Pr.03-10 (Analog Frequency Command for Reverse Run)

- 0: Negative frequency is not valid. Forward and reverse run is controlled by digital keyboard or external terminals.
- 1: Negative frequency is valid. Positive frequency = forward run; negative frequency = reverse run. Direction can not be switched by digital keypad or external terminal control.

Calculate the bias:

$$\frac{60-6\text{Hz}}{10\text{V}} = \frac{6-0\text{Hz}}{(0-X\text{V})} \quad X\text{V} = \frac{100}{-9} = -1.11\text{V} \quad \therefore 03-03 = \frac{-1.11}{10} \times 100\% = -11.1\%$$

Calculate the gain:

$$\text{Pr.03-11} = \frac{10\text{V}}{11.1\text{V}} \times 100\% = 90.0\%$$

⚡ 03-11 Analog Input Gain (AVI)

⚡ 03-12 Analog Input Gain (ACI)

Default: 100.0

Settings -500.0-500.0%

📖 Use Pr.03-03-03-12 when the Frequency command source is the analog voltage or current signal.

✎ **03-15** Analog Input Filter Time (AVI)

✎ **03-16** Analog Input Filter Time (ACI)

Default: 0.01

Settings 0.00–20.00 sec.

 Use these input delays to filter a noisy analog signal.

 When the time constant setting is too large, the control is stable but the control response is slow. When the time constant setting is too small, the control response is faster but the control may be unstable. For optimal setting, adjust the setting based on the control stability or the control response.

✎ **03-19** Signal Loss Selection for the Analog Input 4–20 mA

Default: 0

Settings 0: Disable

1: Continue operation at the last frequency

2: Decelerate to 0 Hz

3: Stop immediately and display “ACE”

 Determines the treatment when the 4–20 mA signal is lost, when ACIc (Pr.03-28 = 0).

 When Pr.03-28 ≠ 2, the voltage input to AVI terminal is 0–10 V or 0–20 mA, and Pr.03-19 is invalid.

 When the setting is 1 or 2, the keypad displays the warning code “ANL”. It keeps blinking until the ACI signal is recovered.

 When the motor drive stops, the warning condition does not continue to exist, so the warning disappears.

✎ **03-20** Multi-function Output (AFM)

Default: 0

Settings 0–23

Function Chart

Settings	Functions	Descriptions
0	Output frequency (Hz)	Maximum frequency Pr.01-00 is processed as 100%.
1	Frequency command (Hz)	Maximum frequency Pr.01-00 is processed as 100%.
2	Motor speed (Hz)	Maximum frequency Pr.01-00 is processed as 100%.
3	Output current (rms)	(2.5 X rated current) is processed as 100%.
4	Output voltage	(2 X rated voltage) is processed as 100%.
5	DC BUS voltage	450 V (900 V) = 100%
6	Power factor	-1.000–1.000 = 100%
7	Power	(2 X rated power) is processed as 100%.
9	AVI	0–10 V = 0–100%
12	Iq current command	(2.5 X rated current) is processed as 100%.
13	Iq feedback value	(2.5 X rated current) is processed as 100%.
14	Id current command	(2.5 X rated current) is processed as 100%.
15	Id feedback value	(2.5 X rated current) is processed as 100%.

Settings	Functions	Descriptions
16	Vq-axis voltage command	250 V (500 V) = 100%
17	Vd-axis voltage command	250 V (500 V) = 100%
21	RS-485 analog output	For InnerCOM analog output
23	Constant voltage output	Pr.03-32 controls the voltage output level. 0–100.00% of Pr.03-32 corresponds to 0–10 V of AFM.

03-21 Analog Output Gain (AFM)

Default: 100.0

Settings 0–500.0%

Adjusts the voltage level outputted to the analog meter from the analog signal (Pr.03-20) output terminal AFM of the drive.

03-22 Analog Output in REV Direction (AFM)

Default: 0

Settings 0: Absolute value of output voltage

1: Reverse output 0 V; forward output 0–10 V

2: Reverse output 5–0 V; forward output 5–10 V

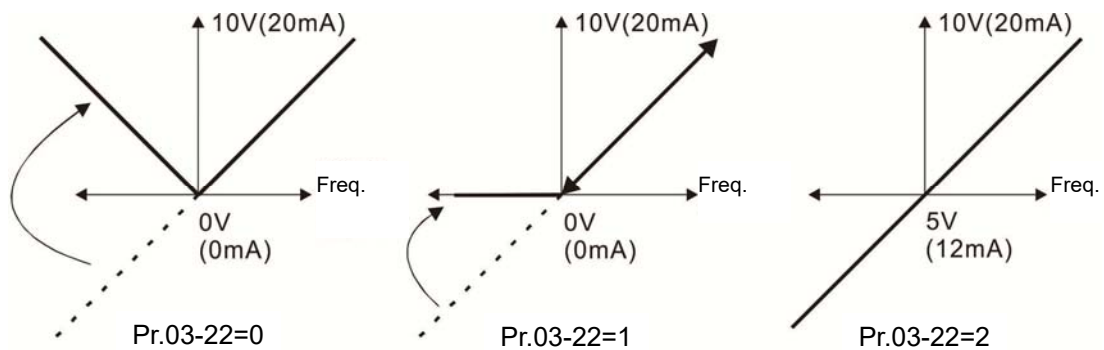

Analog output direction selection

03-27 AFM Output Bias

Default: 0.00

Settings -100.00–100.00%

Example 1: AFM 0–10 V is set to the output frequency, the output equation is

$$10V \times \left(\frac{\text{Output Frequency}}{01-00} \right) \times 03-21 + 10V \times 03-27$$

Example 2: AFM 0–20 mA is set to the output frequency, the output equation is



$$20mA \times \left(\frac{\text{Output Frequency}}{01-00} \right) \times 03-21 + 20mA \times 03-27$$

Example 3: AFM 4–20 mA is set to the output frequency, the output equation is

$$4mA + 16mA \times \left(\frac{\text{Output Frequency}}{01-00} \right) \times 03-21 + 16mA \times 03-27$$

This parameter sets the corresponding voltage for the analog output 0.

- ↗ **03-28** AVI Terminal Input Selection Default: 0
 - Settings 0: 0–10 V
 - 1: 0–20 mA (Pr.03-57–03-62 is valid)
 - 2: 4–20 mA (Pr.03-57–03-62 is valid)
- 📖 Switch between voltage mode and current mode must work with manual switch. Refer to Chapter 06 for more information on AVI terminals.
- ↗ **03-32** AFM DC Output Setting Level Default: 0.00
 - Settings 0.00–100.00%
- ↗ **03-35** AFM Filter Output Time Default: 0.01
 - Settings 0.00–20.00 sec.
- ↗ **03-39** VR Input Selection Default: 1
 - Settings 0: Disable
 - 1: Frequency command
- ↗ **03-40** VR Input Bias Default: 0.0
 - Settings -100.0–100.0%
- ↗ **03-41** VR Positive / Negative Bias Default: 0
 - Settings 0: No bias
 - 1: Lower than or equal to bias
 - 2: Greater than or equal to bias
 - 3: The absolute value of the bias voltage while serving as the center
 - 4: Bias serves as the center
- ↗ **03-42** VR Gain Default: 100.0
 - Settings -500.0–500.0%
- ↗ **03-43** VR Filter Time Default: 0.01
 - Settings 0–2.00 sec.

↗	03-44 Multi-function MO Output by AI Level Source	Default: 0
	Settings 0: AVI 1: ACI	
↗	03-45 AI Upper Level 1	Default: 50
	Settings -100–100%	
↗	03-46 AI Lower Level 2	Default: 10
	Settings -100–100%	
	<p> Multi-function output terminal 67 must work with Pr.03-44 to select input channels. When analog input level is higher than Pr.03-45, multi-function output acts; when analog input level is lower than Pr.03-46, multi-function output terminals stop outputting.</p> <p> When setting levels, AI upper level must be higher than AI lower level.</p>	
↗	03-50 Analog Input Curve Selection	Default: 0
	Settings 0: Regular Curve 1: Three-point curve of AVI (& AI10) 2: Three-point curve of ACI (& AI11)	
↗	03-57 ACI Lowest Point	Default: 4.00
	Settings Pr.03-28 ≠ 1, 0.00–20.00 mA	
↗	03-58 ACI Proportional Lowest Point	Default: 0.00
	Settings Pr.03-28 ≠ 1, 0.00–100.00%	
↗	03-59 ACI Mid-point	Default: 12.00
	Settings Pr.03-28 ≠ 1, 0.00–20.00 mA	
↗	03-60 ACI Proportional Mid-point	Default: 50.00
	Settings Pr.03-28 ≠ 1, 0.00–100.00%	
↗	03-61 ACI Highest Point	Default: 20.00
	Settings Pr.03-28 ≠ 1, 0.00–20.00 mA	
↗	03-62 ACI Proportional Highest Point	Default: 100.00
	Settings Pr.03-28 ≠ 1, 0.00–100.00%	

- 📖 When Pr.03-28 ≠ 1, the ACI setting is 0–20 mA or 4–20 mA and the unit is current (mA).
- 📖 When you set the analog input ACI to the Frequency command, 100% corresponds to Fmax (Pr.01-00 Maximum Operation Frequency).
- 📖 The output % becomes 0% when the ACI input value is lower than lowest point setting.

For example:

If Pr.03-57 = 2 mA; Pr.03-58 = 10%, then the output becomes 0% when the AVI input is ≤ 2 mA.

If the ACI input swings between 2 mA and 2.1 mA, the drive's output frequency oscillates between 0% and 10%.

↗	03-63 AVI Voltage Lowest Point	Default: 0.00
	Settings 0.00–10.00 V	
↗	03-64 AVI Voltage Proportional Lowest Point	Default: 0.00
	Settings -100.00–100.00%	
↗	03-65 AVI Voltage Mid-point	Default: 5.00
	Settings 0.00–10.00 V	
↗	03-66 AVI Voltage Proportional Mid-point	Default: 50.00
	Settings -100.00–100.00%	
↗	03-67 AVI Voltage Highest Point	Default: 10.00
	Settings 0.00–10.00 V	
↗	03-68 AVI Voltage Proportional Highest Point	Default: 100.00
	Settings -100.00–100.00%	

📖 When you set the positive voltage AVI to the Frequency command, 100% corresponds to Fmax (Pr.01-00 Maximum Operation Frequency) and the motor runs in the forward direction.

📖 The requirement for these three parameters (Pr.03-63, Pr.03-65 and Pr.03-67) is Pr.03-63 < Pr.03-65 < Pr.03-67. The values for three proportional points (Pr.03-64, Pr.03-66 and Pr.03-68) have no limits. There is a linear calculation between two points.

📖 The output % becomes 0% when the positive voltage AVI input value is lower than lowest point setting.

For example:

If Pr.03-63 = 1 V; Pr.03-64 = 10%, then the output becomes 0% when the AVI input is ≤ 1 V.

If the AVI input swings between 1 V and 1.1 V, the drive's output frequency oscillates between 0% and 10%.

04 Multi-step Speed Parameters

✎ You can set this parameter during operation.

✎	04-00	1 st Step Speed Frequency
✎	04-01	2 nd Step Speed Frequency
✎	04-02	3 rd Step Speed Frequency
✎	04-03	4 th Step Speed Frequency
✎	04-04	5 th Step Speed Frequency
✎	04-05	6 th Step Speed Frequency
✎	04-06	7 th Step Speed Frequency
✎	04-07	8 th Step Speed Frequency
✎	04-08	9 th Step Speed Frequency
✎	04-09	10 th Step Speed Frequency
✎	04-10	11 th Step Speed Frequency
✎	04-11	12 th Step Speed Frequency
✎	04-12	13 th Step Speed Frequency
✎	04-13	14 th Step Speed Frequency
✎	04-14	15 th Step Speed Frequency

Default: 0.00

Settings 0.00–599.00 Hz

📖 Use the multi-function input terminals (refer to settings 1–4 of Pr.02-01–02-05 Multi-function Input Command) to select the multi-step speed command (the maximum is 15th step speed). Pr.04-00 to 04-14 sets the multi-step speed frequency as shown in the following diagram.

📖 The external terminal/digital keypad/communication controls the RUN and STOP commands with Pr.00-21.

📖 You can set each multi-step speed between 0.00–599.00 Hz during operation.

📖 Explanation for the timing diagram of the multi-step speed and external terminals

The related parameter settings are:

1. Pr.04-00–04-14: sets the 1st–15th multi-step speed (to set the frequency of each step speed).
2. Pr.02-01–02-05: sets the multi-function input terminals (multi-step speed command 1–4).

📖 Related parameters:

- Pr.01-22 JOG frequency setting
- Pr.02-01 multi-function input command 1 (MI1)
- Pr.02-02 multi-function input command 2 (MI2)
- Pr.02-03 multi-function input command 3 (MI3)
- Pr.02-04 multi-function input command 4 (MI4)
- Pr.02-05 multi-function input command 4 (MI5)

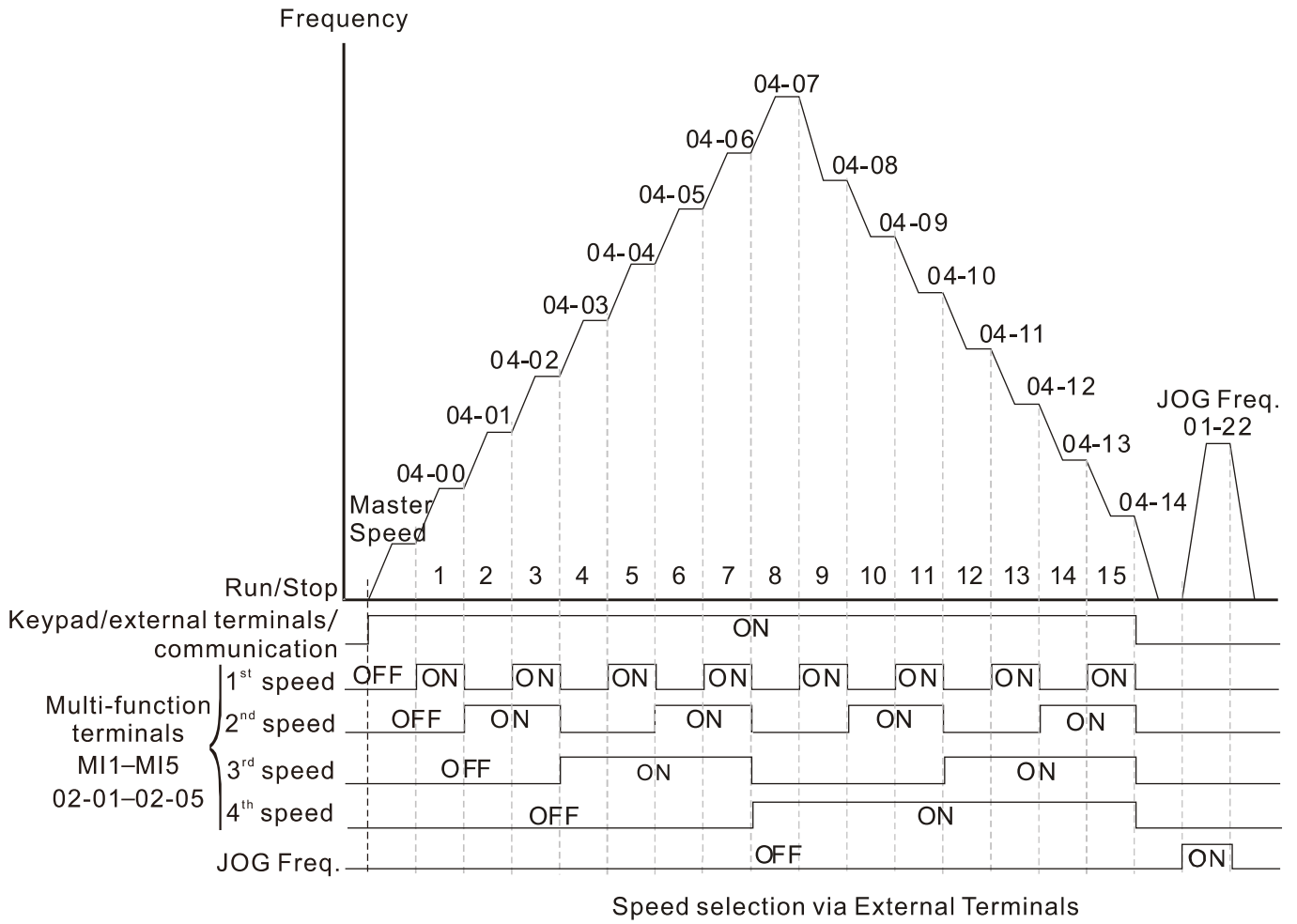

05 Motor Parameters

✎ You can set this parameter during operation.

05-00 Motor Parameter Auto-Tuning

Default: 0

- Settings
- 0: No function
 - 1: Dynamic test for induction motor (IM)
 - 2: Static test for induction motor (IM)
 - 13: High frequency stall test for PM synchronous motor

05-01 Full-load Current for Induction Motor 1 (A)

Unit: Ampere

Default: #.##

Settings 10–120 % of the drive's rated current

📖 Sets this value according to the rated current of the motor as indicated on the motor nameplate. The default is 90% of the drive's rated current.

Example: The rated current for a 7.5 HP (5.5 kW) motor is 25 A. The default is 22.5 A.

The setting range is 2.5–30 A. ($25 \times 10\% = 2.5$ A and $25 \times 120\% = 30$ A).

✎ 05-02 Rated Power for Induction Motor 1 (kW)

Default: #.##

Settings 0–655.35 kW

📖 Sets the rated power for motor 1. The default is the drive's power value.

✎ 05-03 Rated Speed for Induction Motor 1 (rpm)

Default: 1710

Settings 0–65535 rpm
1710 (60 Hz 4 poles); 1410 (50 Hz 4 poles)

📖 Sets the rated speed for the motor as indicated on the motor nameplate.

05-04 Number of Poles for Induction Motor 1

Default: 4

Settings 2–20

📖 Sets the number of poles for the motor (must be an even number).

📖 Set up Pr.01-01 and Pr.05-03 before setting up Pr.05-04 to make sure the motor operates normally.

05-05 No-load Current for Induction Motor 1 (A)

Unit: Ampere

Default: #.##

Settings 0.00–Pr.05-01 default

📖 The default is 40% of the motor's rated current.

05-06	Stator Resistance (Rs) for Induction Motor 1	
05-07	Rotor Resistance (Rr) for Induction Motor 1	Default: #.###
	Settings 0.000–65.535 Ω	
05-08	Magnetizing Inductance (Lm) for Induction Motor 1	
05-09	Stator Inductance (Lx) for Induction Motor 1	Default: #.#
	Settings 0.0–6553.5 mH	
05-13	Full-load Current for Induction Motor 2 (A)	Unit: Ampere Default: #.##
	Settings 10–120% of the drive's rated current	
	<p>📖 Set this value according to the rated current of the motor as indicated on the motor nameplate. The default is 90% of the drive's rated current.</p> <p>Example: The rated current for a 7.5 HP (5.5 kW) motor is 25 A. The default is 22.5 A.</p> <p>The setting range is 2.5–30 A. ($25 \times 10\% = 2.5\text{ A}$ and $25 \times 120\% = 30\text{ A}$)</p>	
05-14	Rated Power for Induction Motor 2 (kW)	Default: #.##
	Settings 0.00–655.35 kW	
	📖 Sets the rated power for motor 2. The default is the drive's power value.	
05-15	Rated Speed for Induction Motor 2 (rpm)	Default: 1710
	Settings 0–65535 rpm 1710 (60 Hz 4 poles); 1410 (50 Hz 4 poles)	
	📖 Sets the rated speed for the motor as indicated on the motor nameplate.	
05-16	Number of Poles for Induction Motor 2	Default: 4
	Settings 2–20	
	<p>📖 Sets the number of poles for the motor (must be an even number).</p> <p>📖 Set up Pr.01-35 and Pr.05-15 before setting up Pr.05-04 to make sure the motor operates normally.</p>	
05-17	No-load Current for Induction Motor 2 (A)	Unit: Ampere Default: #.##
	Settings 0.00–Pr.05-13 default	
	📖 The default is 40% of the motor's rated current.	

05-18 Stator Resistance (Rs) for Induction Motor 2

05-19 Rotor Resistance (Rr) for Induction Motor 2

Default: #.###

Settings 0.000–65.535 Ω

05-20 Magnetizing Inductance (Lm) for Induction Motor 2

05-21 Stator Inductance (Lx) for Induction Motor 2

Default: #.#

Settings 0.0–6553.5 mH

05-22 Multi-motors (Induction) Selection

Default: 1

Settings 1: Motor 1

2: Motor 2

 Sets the motor operated by the AC motor drive. Multi-motors selection only supports single control mode. For example, when you set motor 1 as SVC control mode, the control mode of motor 2 is also set as SVC.

 **05-23** Frequency for Y-connection / Δ-connection Switch for an Induction Motor

Default: 60.00

Settings 0.00–599.00 Hz

05-24 Y-connection / Δ-connection Switch for an Induction Motor

Default: 0

Settings 0: Disable

1: Enable

 **05-25** Delay Time for Y-connection / Δ-connection Switch for an Induction Motor

Default: 0.200

Settings 0.000–60.000 sec.

 You can apply Pr.05-23–Pr.05-25 in a wide range of motors, and the motor coil executes the Y-connection / Δ-connection switch as required. The wide range motors are related to the motor design. In general, the motor has higher torque with low speed Y-connection and has higher speed with high speed Δ-connection

 Pr.05-24 enables and disables the switch of Y-connection / Δ-connection.

 When you set Pr.05-24 as 1, the drive uses the Pr.05-23 setting and current motor frequency, and switches the current motor to Y-connection or Δ-connection. You can switch the relevant motor parameter settings simultaneously.

 Pr.05-25 sets the switch delay time of Y-connection / Δ-connection.

 When the output frequency reaches the Y-connection / Δ-connection switch frequency, the drive delays according to Pr.05-25 before activating the multi-function output terminals.

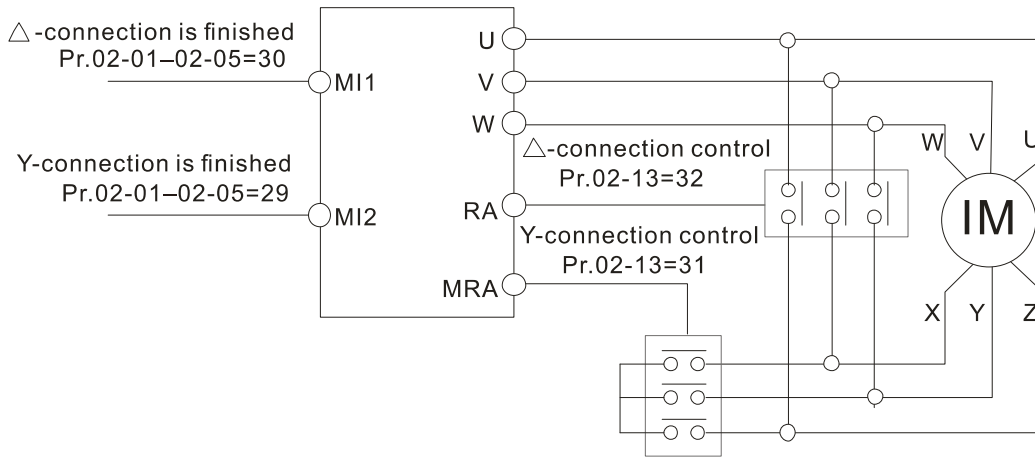

Y- Δ connection switch: can be used for wide range motors.
 Y-connection for low speed: higher torque can be used for rigid tapping.
 Δ-connection for high speed: higher torque can be used for high-speed drilling.

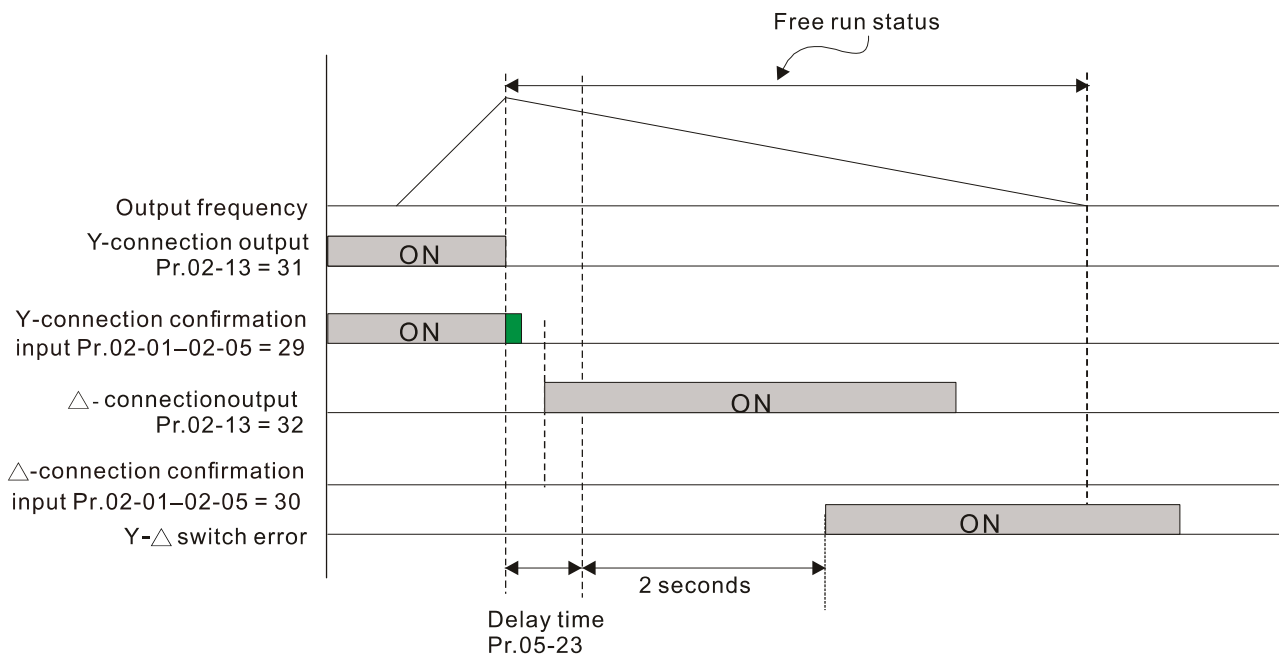
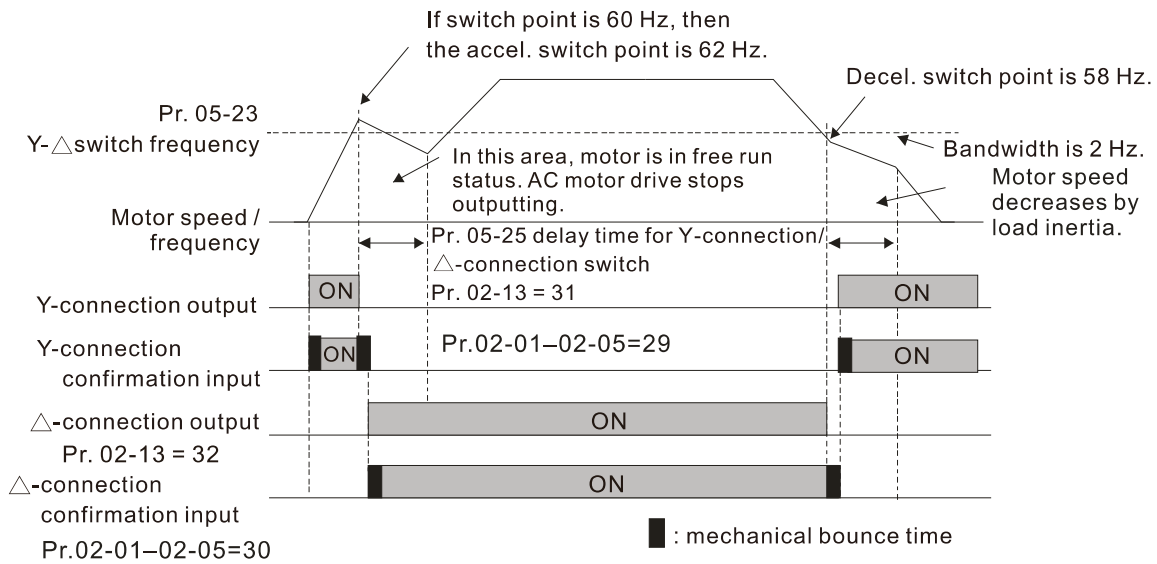

05-26	Accumulated Watt-second for a Motor in Low Word (W-msec.)
--------------	---

05-27	Accumulated Watt-second for a Motor in High Word (W-sec.)
--------------	---

05-28	Accumulated Watt-hour for a Motor (W-Hour)
--------------	--

05-29	Accumulated Watt-hour for a Motor in Low Word (kW-Hour)
--------------	---

05-30	Accumulated Watt-hour for a Motor in High Word (MW-Hour)
--------------	--

Default: ##

Settings Read only

 Pr.05-26–05-30 records the amount of power the motors consume. The accumulation begins when the drive is activated and the record is saved when the drive stops or turns OFF. The amount of consumed watts continues to accumulate when the drive is activated again. To clear the accumulation, set Pr.00-02 as 5 to return the accumulation record to 0.

 The accumulated total kilowatts of the motor per hour = Pr.05-30 x 1000000 + Pr.05-29 x 1000 + Pr.05-28 Wh

Example: when Pr.05-30 = 76 MWh and Pr.05-29 = 150 kWh, Pr.05-28 = 400 Wh (or 0.4 kWh), the accumulated total kilowatts of the motor per hour = 76 x 1000000 + 150 x 1000 + 40 = 76150400 Wh = 76150.4 kWh

05-31	Accumulated Motor Operation Time (Min.)
--------------	---

Default: 0

Settings 0–1439

05-32	Accumulated Motor Operation Time (Day)
--------------	--

Default: 0

Settings 0–65535

 Use Pr.05-31 and Pr.05-32 to record the motor operation time. To clear the operation time, set Pr.05-31 and Pr.05-32 as 00. An operation time shorter than 60 seconds is not recorded.

05-33	Induction Motor (IM) or Permanent Magnet Synchronous Motor Selection
--------------	--

Default: 0

Settings 0: Induction Motor

1: SPM

2: IPM

05-34	Full-load Current for a Permanent Magnet Synchronous Motor
--------------	--

Default: ##

Settings 0–120% of the drive's rated current

05-35	Rated Power for a Permanent Magnet Synchronous Motor
--------------	--

Default: ###

Settings 0.00–655.35 kW

 Sets the rated power for the permanent magnet synchronous motor. The default is the drive's power value.

05-36 Rated Speed for a Permanent Magnet Synchronous Motor

Default: 2000

Settings 0–65535 rpm

05-37 Number of Poles for a Permanent Magnet Synchronous Motor

Default: 10

Settings 0–65535

05-39 Stator Resistance for a Permanent Magnet Synchronous Motor

Default: 0.000

Settings 0.000–65.535 Ω

05-40 Permanent Magnet Synchronous Motor Ld

Default: 0.00

Settings 0.00–655.35 mH

05-41 Permanent Magnet Synchronous Motor Lq

Default: 0.00

Settings 0.00–655.35 mH

05-43 Ke parameter for a Permanent Magnet Synchronous Motor

Unit: V / 1000 rpm

Default: 0

Settings 0–65535

06 Protection Parameters (1)

✦ You can set this parameter during operation.

✦ 06-00 Low Voltage Level

Settings	Default:
115V / 230V: 150.0–220.0 V _{DC}	180.0
460V: 300.0–440.0 V _{DC}	360.0

- 📖 Sets the Low Voltage (LV) level. When the DC BUS voltage is lower than Pr.06-00, the drive stops output and the motor free runs to a stop.
- 📖 If the LV fault is triggered during operation, the drive stops output and the motor free runs to a stop. There are three LV faults, LvA (LV during acceleration), Lvd (LV during deceleration), and Lvn (LV in constant speed) that are triggered according to the status of acceleration or deceleration. You must press RESET to clear the LV fault. The drive automatically restarts if you set to restart after momentary power loss (refer to Pr.07-06 Restart after Momentary Power Loss and Pr.07-07 Allowed Power Loss Duration for details).
- 📖 If the LV fault is triggered when the drive is in STOP status, the drive displays LvS (LV during stop), which is not recorded, and the drive restarts automatically when the input voltage is higher than the LV level of 30 V (230V series) or 60 V (460V series).

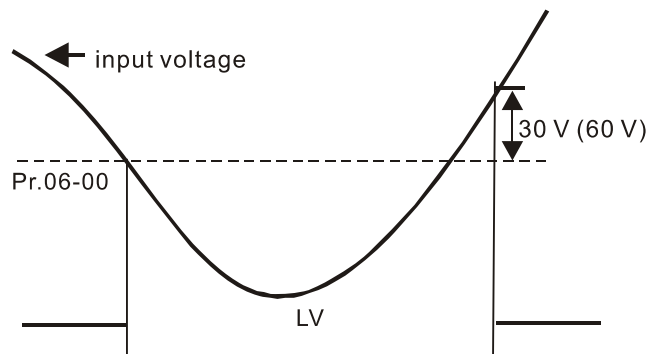

✦ 06-01 Over-voltage Stall Prevention

Settings	Default:
0: Disabled	
115V / 230V: 0.0–450.0 V _{DC}	380.0
460V: 0.0–900.0 V _{DC}	760.0

- 📖 Setting Pr.06-01 to 0.0 disables the over-voltage stall prevention function (connected with braking unit or braking resistor). Use this setting when braking units or resistors are connected to the drive.
- 📖 Setting Pr.06-01 to a value > 0 enables the over-voltage stall prevention. This setting refers to the power supply system and loading. If the setting is too low, then over-voltage stall prevention is easily activated, which may increase deceleration time.
- 📖 Related parameters:
Pr.01-13, Pr.01-15, Pr.01-17, Pr.01-19 Deceleration Time 1–4, Pr.02-13 Multi-function Output 1 (Relay 1), Pr.02-16 Multi-function Output 2 (MO1), and Pr.06-02 Selection for Over-voltage Stall Prevention.

06-02 Selection for Over-voltage Stall Prevention

Default: 0

- Settings 0: Traditional over-voltage stall prevention
- 1: Smart over-voltage stall prevention

- 📖 Use this function when you are unsure about the load inertia. When stopping under normal load, the over-voltage does not occur during deceleration and meet the deceleration time setting. Sometimes it may not stop due to over-voltage during decelerating to STOP when the load regenerative inertia increases. In this case, the AC motor drive extends the deceleration time automatically until the drive stops.
- 📖 When you set Pr.06-02 to 0, during deceleration the motor exceeds the synchronous speed due to load inertia. In this case, the motor becomes an electrical generator. The DC BUS voltage may exceed its maximum allowable value due to motor regeneration in some situations, such as loading inertia being too high or deceleration time being set too short. When you enable traditional over-voltage stall prevention and the DC BUS voltage detected is too high, the drive stops decelerating (output frequency remains unchanged) until the DC BUS voltage drops below the setting value.

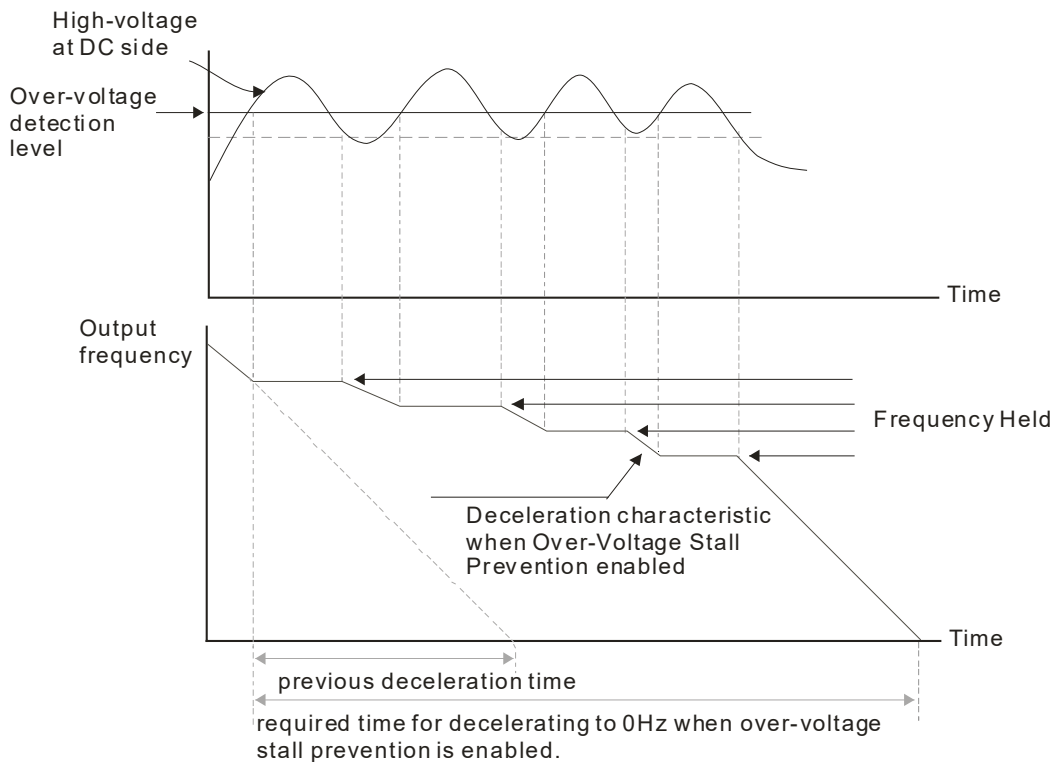

- 📖 When you set Pr.06-02 to 1, to use smart over-voltage stall prevention during deceleration, the drive maintains the DC BUS voltage when decelerating and prevents the drive from OV.

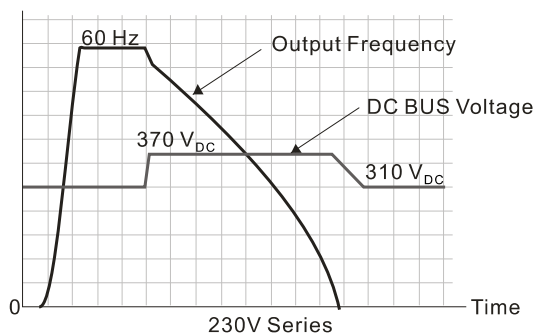

When you enable the over-voltage stall prevention, the drive's deceleration time is longer than the setting. If you encounter any problem with deceleration time, refer to the following guides for troubleshooting.

1. Increase the deceleration time to a suitable value.
2. Install a brake resistor (refer to Section 7-1 All Brake Resistors and Brake Units Used in AC Motor Drives for details) to dissipate the electrical energy that is generated from the motor.

Related parameters:

Pr.01-13, Pr.01-15, Pr.01-17, Pr.01-19 Deceleration Time 1–4, Pr.02-13 Multi-function Output 1 (Relay 1), Pr.02-16 Multi-function Output 2 (MO1), and Pr.06-01 Over-voltage Stall Prevention.

06-03 Over-current Stall Prevention during Acceleration

Settings	Normal Load: 0–150% (100% corresponds to the rated current of the drive)	Heavy Load: 0–200% (100% corresponds to the rated current of the drive)	Default:
			120
			180

This parameter only works in VF, VFPG, and SVC modes.

If the motor load is too large or the drive's acceleration time is too short, the output current of the drive may be too high during acceleration, and it may cause motor damage or trigger protection functions (OL or OC). Use this parameter to prevent these situations.

During acceleration, the output current of the drive may increase abruptly and exceed the setting value of Pr.06-03. In this case, the drive stops accelerating and keeps the output frequency constant, and then continues to accelerate until the output current decreases.

When you enable the over-current stall prevention, the drive's acceleration time is longer than the setting.

When the over-current stall prevention occurs because the motor capacity is too small or operates in the default, decrease the Pr.06-03 setting value.

When you encounter any problem with the acceleration time, refer to the following guides for troubleshooting.

1. Increase the deceleration time to a suitable value.
2. Set Pr.01-44 Auto-Acceleration and Auto-Deceleration Setting to 1, 3 or 4 .
(auto-acceleration)

Related parameters:

Pr.01-12, 01-14, 01-16, 01-18 Acceleration Time 1–4), Pr.01-44

Auto-Acceleration and Auto-Deceleration Setting, Pr.02-13 Multi-function Output 1 (Relay 1),

Pr.02-16 Multi-function Output 2 (MO1).

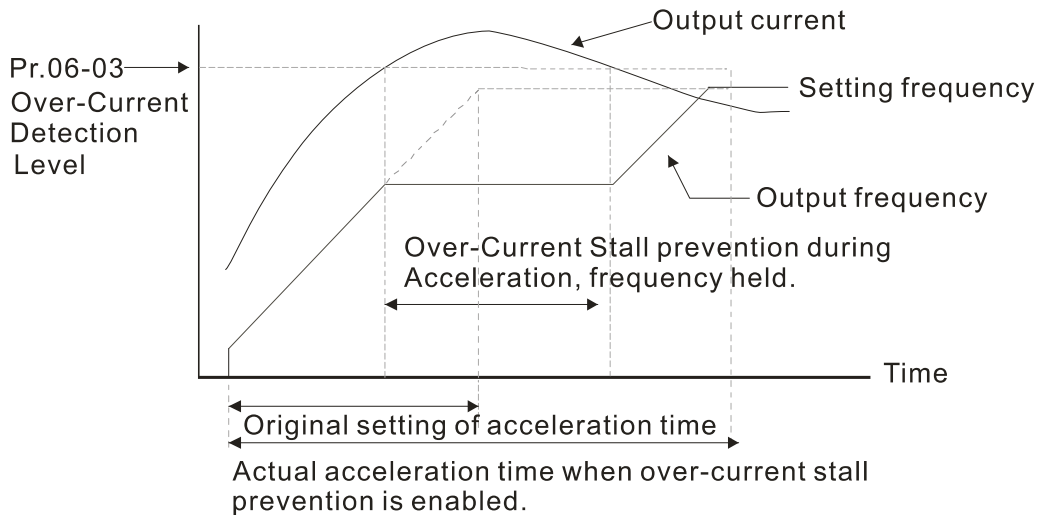









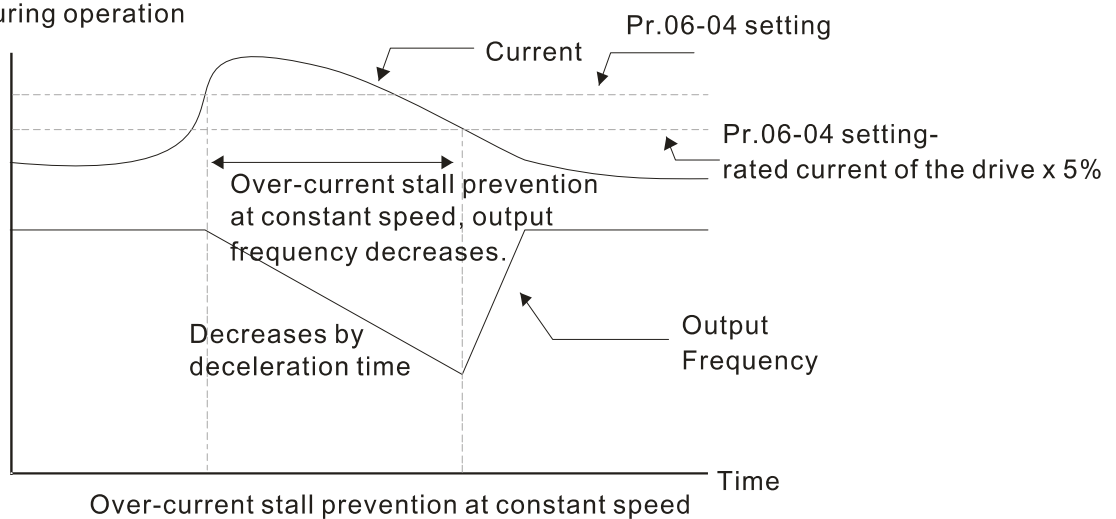

06-04 Over-current Stall Prevention during Operation

Settings	Default:
Normal duty: 0–150% (100% corresponds to the rated current of the drive)	120
Heavy duty: 0–200% (100 % corresponds to the rated current of the drive)	180

- 📖 This parameter only works in VF and SVC modes.
- 📖 This is a protection for the drive to decrease output frequency automatically when the motor over-loads abruptly during constant motor operation.
- 📖 If the output current exceeds the setting value for Pr.06-04 when the drive is operating, the drive decreases output frequency (according to Pr.06-05) to prevent the motor from stalling. If the output current is lower than the setting value for Pr.06-04, the drive accelerates (according to Pr.06-05) again to the setting frequency.

Pr.06-04
Over-current stall prevention level during operation



-  **06-05** Accel./Decel. Time Selection for Stall Prevention at Constant Speed
 Default: 0
- Settings 0: By current acceleration / deceleration time
 1: By the 1st acceleration / deceleration time
 2: By the 2nd acceleration / deceleration time
 3: By the 3rd acceleration / deceleration time
 4: By the 4th acceleration/deceleration time
 5: By auto-acceleration / auto-deceleration
-
-  Sets the acceleration/deceleration time selection when stall prevention occurs at constant speed.
-  **06-06** Over-torque Detection Selection (Motor 1)
 Default: 0
- Settings 0: No function
 1: Continue operation after over-torque detection during constant speed operation
 2: Stop after over-torque detection during constant speed operation
 3: Continue operation after over-torque detection during RUN
 4: Stop after over-torque detection during RUN
-  **06-09** Over-torque Detection Selection (Motor 2)
 Default: 0
- Settings 0: No function
 1: Continue operation after over-torque detection during constant speed operation
 2: Stop after over-torque detection during constant speed operation
 3: Continue operation after over-torque detection during RUN
 4: Stop after over-torque detection during RUN
-
-  When you set Pr.06-06 and Pr.06-09 to 1 or 3, a warning message displays but there is no error record.
-  When you set Pr.06-06 and Pr.06-09 to 2 or 4, a warning message displays and there is an error record.
-  **06-07** Over-torque Detection Level (Motor 1)
 Default: 120
- Settings 10–250% (100% corresponds to the rated current of the drive)
-  **06-08** Over-torque Detection Time (Motor 1)
 Default: 0.1
- Settings 0.0–60.0 sec.
-  **06-10** Over-torque Detection Level (Motor 2)
 Default: 120
- Settings 10–250% (100% corresponds to the rated current of the drive)

➤ **06-11** Over-torque Detection Time (Motor 2)

Default: 0.1

Settings 0.0–60.0 sec.

- 📖 When the output current exceeds the over-torque detection level (Pr.06-07 or Pr.06-10) and also exceeds the over-torque detection time (Pr.06-08 or Pr.06-11), the over-torque detection follows the setting of Pr.06-06 and Pr.06-09.
- 📖 When you set Pr.06-06 or Pr.06-09 to 1 or 3, an ot1 / ot2 warning displays while the drive keeps running. The warning remains on until the output current is smaller than 5% of the over-torque detection level.

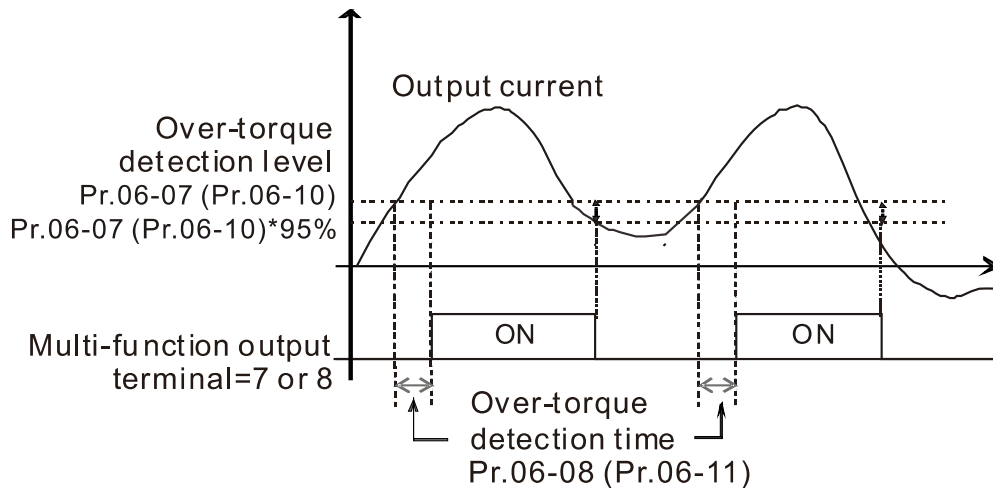

- 📖 When you set Pr.06-06 or Pr.06-09 to 2 or 4, an ot1 / ot2 warning displays and the drive stops running after over-torque detection. The drive keeps running after you manually reset it.

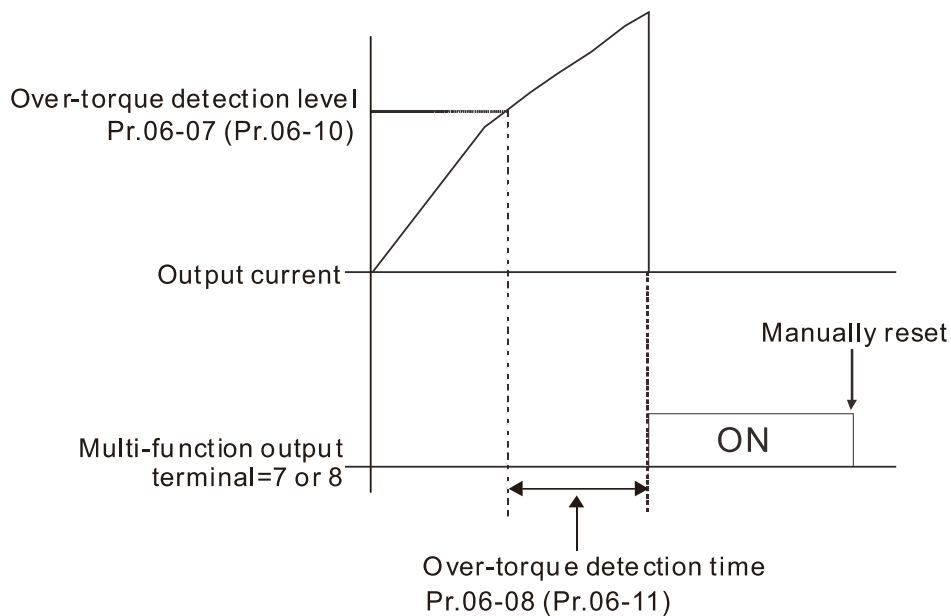

➤ **06-13** Electronic Thermal Relay Selection 1 (Motor 1)

➤ **06-27** Electronic Thermal Relay Selection 2 (Motor 2)

Default: 2

- Settings
- 0: Inverter motor (with external forced cooling)
 - 1: Standard motor (motor with fan on the shaft)
 - 2: Disable

- 📖 Prevents self-cooled motor from overheating under low speed. Use an electronic thermal relay to limit the drive's output power.
- 📖 Setting the parameter to 0 is suitable for an inverter motor (motor fan using an independent power supply). For this kind of motor, there is no significant correlation between cooling capacity and motor speed. Therefore, the action of electronic thermal relays remain stable in low speed to ensure the load capability of the motor in low speed.
- 📖 Setting the parameter to 1 is suitable for standard motor (motor fan is fixed on the rotor shaft). For this kind of motor, the cooling capacity is lower in low speed; therefore, the action of an electronic thermal relay reduces the action time to ensure the life of motor.
- 📖 When the power is cycled frequently, if the power is switched OFF, the electronic thermal relay protection is reset; therefore even setting the parameter to 0 or 1 may not protect the motor well. If there are several motors connected to one drive, install an electronic thermal relay in each motor.

⚡ **06-14** Electronic Thermal Relay Action Time 1 (Motor 1)

⚡ **06-28** Electronic Thermal Relay Action Time 2 (Motor 2)

Default: 60.0

Settings 30.0–600.0 sec.

- 📖 Set the parameter to 150% of motor rated current and use with the setting of Pr.06-14 and Pr.06-28 to prevent motor damage due to overheating. When it reaches the setting, the drive displays “EoL1 / EoL2”, and the motor free runs to stop.
- 📖 Use this parameter to set the action time of the electronic thermal relay. It works based on the I2t characteristic curve of electronic thermal relay, the output frequency and current of the drive, and the operation time to prevent the motor from overheating.

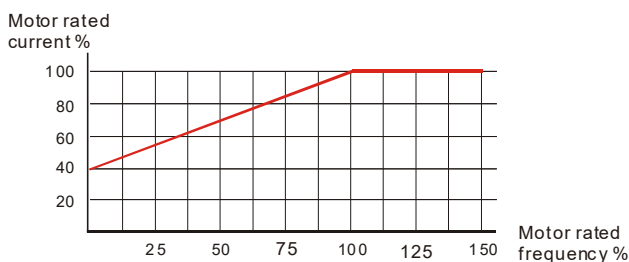

Motor cooling curve with shaft-fixed fan

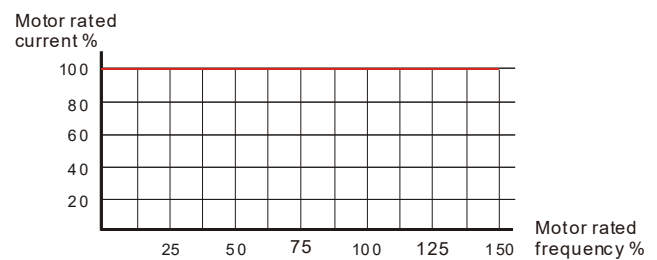

Motor cooling curve with independent fan

- 📖 The action of the electronic thermal relay depends on the settings for Pr.06-13 and Pr.06-27.

1. Pr.06-13 or Pr.06-27 set to 0 (using inverter motor):

When the output current of the drive is higher than 150% of motor rated current (refer to the motor cooling curve with independent fan), the drive starts to count the time. The electronic thermal relay acts when the accumulated time exceeds Pr.06-14 or Pr.06-28.

2. Pr.06-13 or Pr.06-27 set to 1 (using standard motor):

When the output current of the drive is higher than 150% of the motor rated current (refer to the motor cooling curve with shaft-fixed fan), the drive starts to count the time. The electronic thermal relay acts when the accumulated time exceeds Pr.06-14 or Pr.06-28.

The actual electronic thermal relay action time adjusts according to the drive output current (shown as the motor loading rate %). The action time is short when the current is high, and

the action time is long when the current is low. Refer to the following chart:

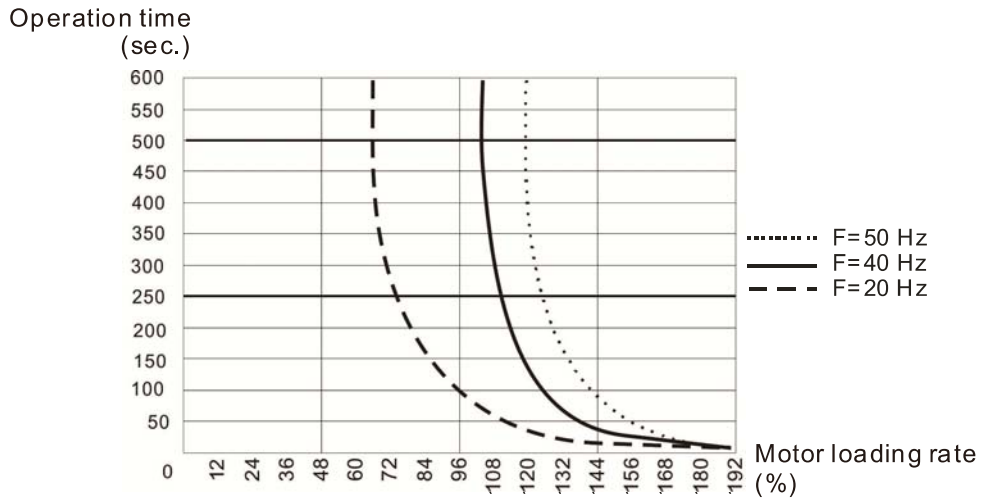

➤ **06-15** Temperature Level Over-heat (OH) Warning

Default: 105.0

Settings 0.0–110.0 °C

📖 The default of this parameter is 105°C. When using Heavy Duty or Sensorless control mode, the OH warning is disabled if Pr.06-15 is not reduced. When the temperature reaches 100°C, the drive stops with an IGBT over-heat fault.

📖 When using any control mode except Normal Duty or Sensorless mode, if Pr.06-15 is set to 110°C, when the temperature reaches 110°C, the drive stops with an IGBT over-heat fault.

➤ **06-16** Stall Prevention Limit Level

Default: 100

Settings 0–100% (Refer to Pr.06-03, Pr.06-04)

📖 Sets the over-current stall prevention level when operation frequency is larger than Pr.01-01.

Example: When Pr.06-03 = 150%, Pr.06-04 = 100% and Pr.06-16 = 80%.

The over-current stall prevention level during acceleration:

$$\text{Pr.06-03} * \text{Pr.06-16} = 150 * 80\% = 120\%.$$

The over-current stall prevention level during operation:

$$\text{Pr.06-04} * \text{Pr.06-16} = 100 * 80\% = 80\%.$$

06-17 Fault Record 1

06-18 Fault Record 2

06-19 Fault Record 3

06-20 Fault Record 4

06-21 Fault Record 5

06-22 Fault Record 6

Default: 0

Settings 0: No fault record

1: Over-current during acceleration (ocA)

2: Over-current during deceleration (ocd)

- 3: Over-current during constant speed (ocn)
- 4: Ground fault (GFF)
- 6: Over-current at stop (ocS)
- 7: Over-voltage during acceleration (ovA)
- 8: Over-voltage during deceleration (ovd)
- 9: Over-voltage during constant speed (ovn)
- 10: Over-voltage at stop (ovS)
- 11: Low-voltage during acceleration (LvA)
- 12: Low-voltage during deceleration (Lvd)
- 13: Low-voltage during constant speed (Lvn)
- 14: Low-voltage at stop (LvS)
- 15: Phase loss protection (orP)
- 16: IGBT over-heat (oH1)
- 18: TH1 open: IGBT over-heat protection error (tH1o)
- 21: Drive over-load (oL)
- 22: Electronic thermal relay protection 1 (EoL1)
- 23: Electronic thermal relay protection 2 (EoL2)
- 24: Motor PTC over-heat (oH3)
- 26: Over-torque 1 (ot1)
- 27: Over-torque 2 (ot2)
- 28: Low current (uC)
- 31: Memory read-out error (cF2)
- 33: U-phase current detection error (cd1)
- 34: V-phase current detection error (cd2)
- 35: W-phase current detection error (cd3)
- 36: Clamp current detection error (Hd0)
- 37: Over-current detection error (Hd1)
- 40: Auto-tuning error (AUE)
- 41: PID feedback loss (AFE)
- 48: Analog current input loss (ACE)
- 49: External fault input (EF)
- 50: Emergency stop (EF1)
- 51: External Base Block (B.B.)
- 52: Password error (Pcod)
- 54: Communication error (CE1)
- 55: Communication error (CE2)
- 56: Communication error (CE3)
- 57: Communication error (CE4)
- 58: Communication time-out (CE10)
- 61: Y-connection / Δ -connection switch error (ydc)
- 62: Deceleration Energy Backup Error (dEb)
- 72: Channel 1 (S1–DCM) safety loop error (STL1)

- 76: Safe Torque Off (STo)
- 77: Channel 2 (S2-DCM) safety loop error (STL2)
- 78: Internal loop error (STL3)
- 79: U-phase over-current before run (Uoc)
- 80: V-phase over-current before run (Voc)
- 81: W-phase over-current before run (Woc)
- 82: U-phase output phase loss (OPHL)
- 83: V-phase output phase loss (OPHL)
- 84: W-phase output phase loss (OPHL)
- 87: Drive overload in low frequency (oL3)
- 89: Initial rotor position detection error (RoPd)
- 140: GFF detected when power on (Hd6)
- 141: GFF before run (BGFF)
- 142: Auto-tuning error 1 (DC test stage) (AUE1)
- 143: Auto-tuning error 2 (High frequency test stage) (AUE2)
- 144: Auto-tuning error 3 (Rotary test stage) (AUE3)

- When the fault occurs and forces stopping, the fault is recorded in this parameter.
- During stop with low voltage Lv (LvS warning), there is no error record. During operation with mid-low voltage Lv (LvA, Lvd, Lvn error), there is a record.
- When dEb function is valid and enabled, the drive executes dEb and records fault code 62 to Pr.06-17-Pr.06-22 and Pr.14-70-Pr.14-73 simultaneously.

	06-23	Fault Output Option 1
	06-24	Fault Output Option 2
	06-25	Fault Output Option 3
	06-26	Fault Output Option 4

Default: 0

Settings 0-65535 (refer to bit table for fault code)

- Use these parameters with multi-function output terminal (set to 35-38) for the specific requirement. When the fault occurs, the corresponding terminals activate. Convert the binary value to decimal value before you enter the value for Pr.06-23-Pr.06-26.

Fault Code	bit 0	bit 1	bit 2	bit 3	bit 4	bit 5	bit 6
	current	Volt.	OL	SYS	FBK	EXI	CE
0: No fault record							
1: Over-current during acceleration (ocA)	●						
2: Over-current during deceleration (ocd)	●						
3: Over-current during constant speed (ocn)	●						
4: Ground fault (GFF)	●						
6: Over-current at stop (ocS)	●						
7: Over-voltage during acceleration (ovA)		●					
8: Over-voltage during deceleration (ovd)		●					

Fault Code	bit 0	bit 1	bit 2	bit 3	bit 4	bit 5	bit 6
	current	Volt.	OL	SYS	FBK	EXI	CE
9: Over-voltage during constant speed (ovn)		●					
10: Over-voltage at stop (ovS)		●					
11: Low-voltage during acceleration (LvA)		●					
12: Low-voltage during deceleration (Lvd)		●					
13: Low-voltage during constant speed (Lvn)		●					
14: Low-voltage at stop (LvS)		●					
15: Phase loss protection (orP)		●					
16: IGBT over-heat (oH1)			●				
18: TH1 open: IGBT over-heat protection error (tH1o)			●				
21: Drive over-load (oL)			●				
22: Electronic thermal relay protection 1 (EoL1)			●				
23: Electronic thermal relay protection 2 (EoL2)			●				
24: Motor PTC over-heat (oH3)			●				
26: Over-torque 1 (ot1)			●				
27: Over-torque 2 (ot2)			●				
28: Low current (uC)	●						
31: Memory read-out error (cF2)				●			
33: U-phase current detection error (cd1)				●			
34: V-phase current detection error (cd2)				●			
35: W-phase current detection error (cd3)				●			
36: Clamp current detection error (Hd0)				●			
37: Over-current detection error (Hd1)				●			
40: Auto-tuning error (AUE)				●			
41: PID feedback loss (AFE)					●		
48: Analog current input loss (ACE)					●		
49: External fault input (EF)						●	
50: Emergency stop (EF1)						●	
51: External Base Block (B.B.)						●	
52: Password error (Pcod)				●			
54: Communication error (CE1)							●
55: Communication error (CE2)							●
56: Communication error (CE3)							●
57: Communication error (CE4)							●
58: Communication time-out (CE10)							●
61: Y-connection/ Δ -connection switch error (ydc)						●	
62: Deceleration Energy Backup Error (dEb)		●					

Fault Code	bit 0	bit 1	bit 2	bit 3	bit 4	bit 5	bit 6
	current	Volt.	OL	SYS	FBK	EXI	CE
72: Channel 1 (S1–DCM) safety loop error (STL1)				●			
76: Safe Torque Off (STo)				●			
77: Channel 2 (S2–DCM) safety loop error (STL2)				●			
78: Internal loop error (STL3)				●			
79: U-phase over-current before run (Uoc)	●						
80: V-phase over-current before run (Voc)	●						
81: W-phase over-current before run (Woc)	●						
82: U-phase output phase loss (OPHL)	●						
83: V-phase output phase loss (OPHL)	●						
84: W-phase output phase loss (OPHL)	●						
87: Drive overload in low frequency (oL3)			●				
89: Initial rotor position detection error (RoPd)					●		
140: GFF detected when power on (Hd6)				●			
141: GFF before run (BGFF)				●			
142: Auto-tuning error 1 (DC test stage) (AUE1)				●			
143: Auto-tuning error 2 (High frequency test stage) (AUE2)				●			
144: Auto-tuning error 3 (Rotary test stage) (AUE3)				●			

⚡ **06-29** PTC Detection Selection

Default: 0

- Settings
- 0: Warn and continue operation
 - 1: Warn and ramp to stop
 - 2: Warn and coast to stop
 - 3: No warning

- 📖 Sets the operation mode of a drive after you set Pr.06-29 to define PTC detection.
- 📖 Running a motor at low frequency for a long time reduces the cooling function of the motor fan. To prevent the motor from damage due to overheating, use a Positive Temperature Coefficient thermistor on the motor, and connect the thermistor output signal to the drive’s analog input terminals.

⚡ **06-30** PTC Level

Default: 50.0

- Settings 0.0–100.0%

- 📖 Sets AVI / ACI analog input function Pr.03-00 to 6 [Positive temperature coefficient (PTC) thermistor input value]. Use this to set the PTC level; the corresponding value for 100% is the

analog input maximum value.

- 📖 When using the AVI terminal, you must set Pr.03-28 to 1 and switch AVI voltage to 0–10 V. At this time, the AVI input impedance is 20 K Ω .
- 📖 When the temperature reaches to the set protection level, the motor acts according to the settings for Pr.06-29 and displays warning “oH3” (if Pr.06-29 = 1–3). When the temperature is lower than the set protection level, you can press RESET key to clear the fault.
- 📖 The PTC uses the AVI-input and is connected via resistor-divider as shown below:
 1. The voltage between +10V to ACM: lies within 10V–11V.
 2. The impedance for AVI is around 20K Ω . Recommended value for resistor-divider 1K–10K Ω .
 3. Please contact your motor dealer for the curve of temperature and resistance value for PTC.

Protection level (Pr.06-30) = $V+10 \cdot (R_{PTC} // 20K) / [R1 + (R_{PTC} // 20K)]$

V+10: voltage between +10V-ACM, Range 10.4~11.2V_{DC};
 RPTC: motor PTC overheat protection level;
 20K Ω : is AVI input impedance;
 R1: resistor-divider (recommended value: 1–10k Ω)

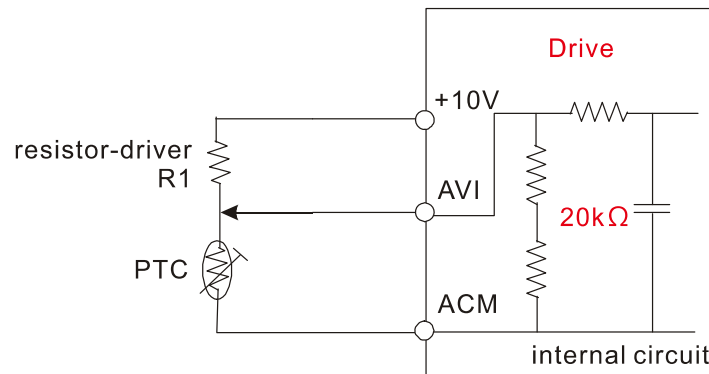

Take the standard PTC thermistor as example: if protection level is 1330 Ω , the voltage between +10V-ACM is 10.5V and resistor-divider R1 is 4.4k Ω .

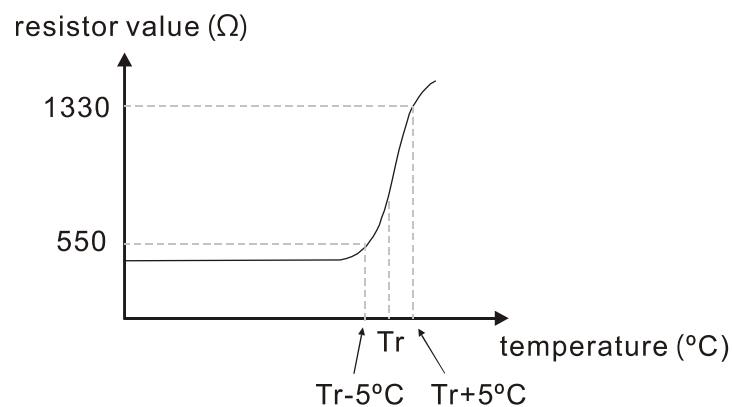

Refer to following calculation for Pr.06-30 setting:

$$1330 // 20000 = (1330 \cdot 20000) / (1330 + 20000) = 1247.07$$

$$10.5 \cdot 1247.07 / (4400 + 1247.07) = 2.32(V) \approx 2.3(V)$$

Pr.06-30 should be set to $2.3 / 10V \cdot \% = 23\%$

06-31 Frequency Command for Malfunction

Default: Read only

Settings 0.00–599.00 Hz

 When a malfunction occurs, check the current Frequency command. If it happens again, it overwrites the previous record.

06-32 Output Frequency at Malfunction

Default: Read only

Settings 0.00–599.00 Hz

 When a malfunction occurs, check the current output frequency. If it happens again, it overwrites the previous record.

06-33 Output Voltage at Malfunction

Default: Read only

Settings 0.0–6553.5 V

 When a malfunction occurs, check the current output voltage. If it happens again, it overwrites the previous record.

06-34 DC Voltage at Malfunction

Default: Read only

Settings 0.0–6553.5 V

 When a malfunction occurs, check the current DC voltage. If it happens again, it overwrites the previous record.

06-35 Output Current at Malfunction

Default: Read only

Settings 0.00–655.35 Amp

 When a malfunction occurs, check the current output current. If it happens again, it overwrites the previous record.

06-36 IGBT Temperature at Malfunction

Default: Read only

Settings 0.0–6553.5°C

 When a malfunction occurs, check the current IGBT temperature. If it happens again, it overwrites the previous record.

06-38 Motor Speed in rpm at Malfunction

Default: Read only

Settings 0–65535 rpm

 When a malfunction occurs, check the current motor speed in rpm. If it happens again, it overwrites the previous record.

06-40 Status of the Multi-function Input Terminal at Malfunction

Default: Read only

Settings 0000h–FFFFh

06-41 Status of the Multi-function Output Terminal at Malfunction

Default: Read only

Settings 0000h–FFFFh

- 📖 When a malfunction occurs, check the current status of the multi-function input/output terminals. If it happens again, it overwrites the previous record.

06-42 Drive Status at Malfunction

Default: Read only

Settings 0000h–FFFFh

- 📖 When a malfunction occurs, check the current drive status (communication address 2101H). If it happens again, it overwrites the previous record.

↗ **06-44** STO Latch Selection

Default: 0

Settings 0: STO Latch
1: STO no Latch

- 📖 Pr.06-44 = 0: STO Alarm Latch. After you clear the cause of the STO Alarm, use a Reset command to clear the STO Alarm.
- 📖 Pr.06-44 = 1: STO Alarm no Latch. After you clear the cause of the STO Alarm, the STO Alarm clears automatically.
- 📖 All of the STL1–STL3 errors are “Alarm Latch” mode (in STL1–STL3 mode, the Pr.06-44 function is not effective).

↗ **06-45** Output Phase Loss Detection Action (OPHL)

Default: 3

Settings 0: Warn and continue operation
1: Warn and ramp to stop
2: Warn and coast to stop
3: No warning

- 📖 The OPHL protect function is active when the setting is not 3.

↗ **06-46** Detection Time for Output Phase Loss

Default: 0.500

Settings 0.000–65.535 sec.

↗ **06-47** Current Detection Level for Output Phase Loss

Default: 1.00

Settings 0.00–100.00%

06-48 DC Brake Time for Output Phase Loss

Default: 0.000

Settings 0.000–65.535 sec.

Setting Pr.06-48 to 0 disables the OPHL detection function.

Status 1: The drive is in operation

When any phase is less than the Pr.06-47 setting, and exceeds the Pr.06-46 setting time, the drive executes according to the Pr.06-45 setting.

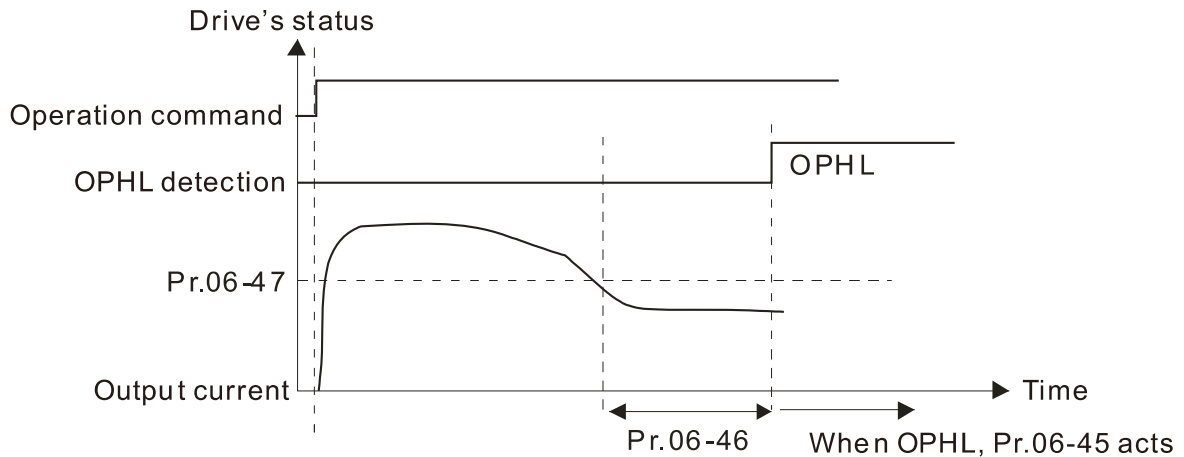

Status 2: The drive is in STOP; Pr.06-48 = 0; Pr.07-02 ≠ 0

After the drive starts, the DC brake operates according to Pr.07-01 and Pr.07-02. During this period, OPHL detection is not active. After the DC brake action is completed, the drive starts to run, and enables the OPHL protection as mentioned above for status 1.

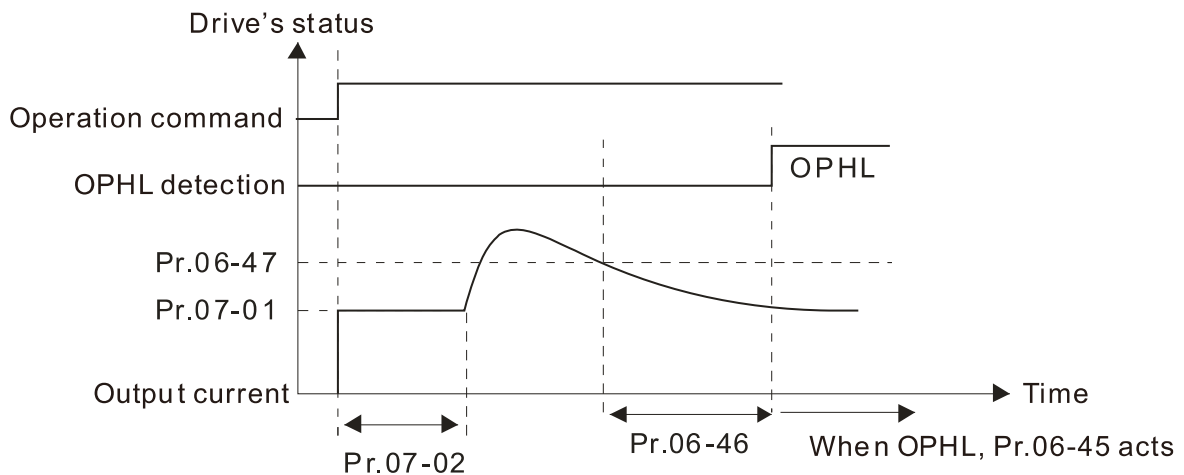

Status 3: The drive is in STOP; Pr.06-48 ≠ 0; Pr.07-02 ≠ 0

When the drive starts, it executes Pr.06-48 first, and then executes Pr.07-02 (DC brake). The DC brake current level in this state includes two parts: one is 20 times the Pr.06-47 setting value in Pr.06-48 setting time; the other is the Pr.07-01 setting value in Pr.07-02 setting time. In this period, if an OPHL happens within the time for Pr.06-48, the drive executes the Pr.06-45 setting after the drive starts counting for half the time of Pr.06-48.

Status 3-1: Pr.06-48≠0, Pr.07-02≠0 (No OPHL detected before operation)

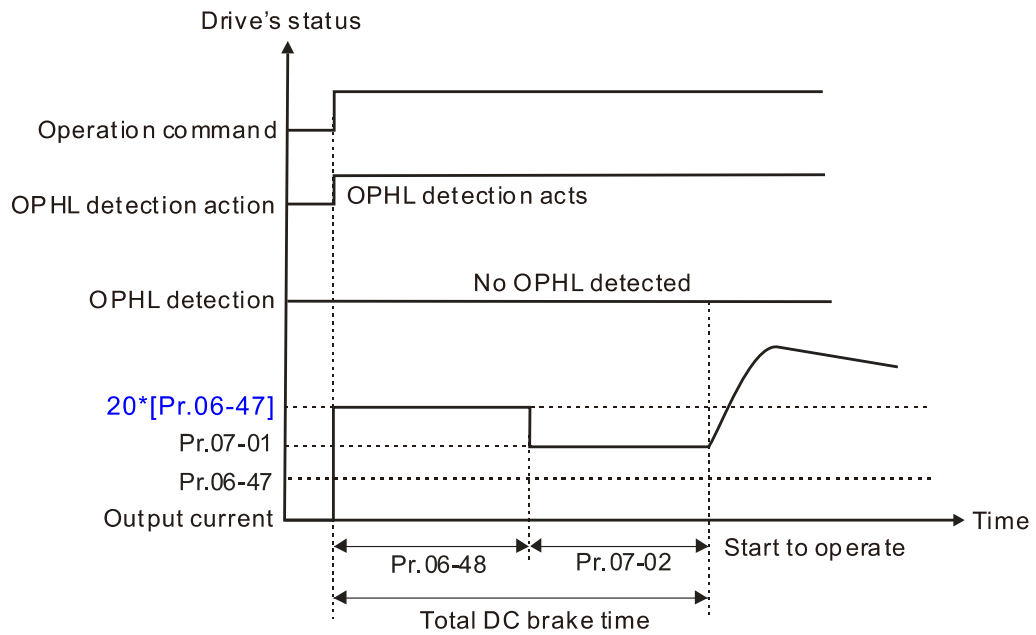

Status 3-2: Pr.06-48≠0, Pr.07-02≠0 (OPHL detected before operation)

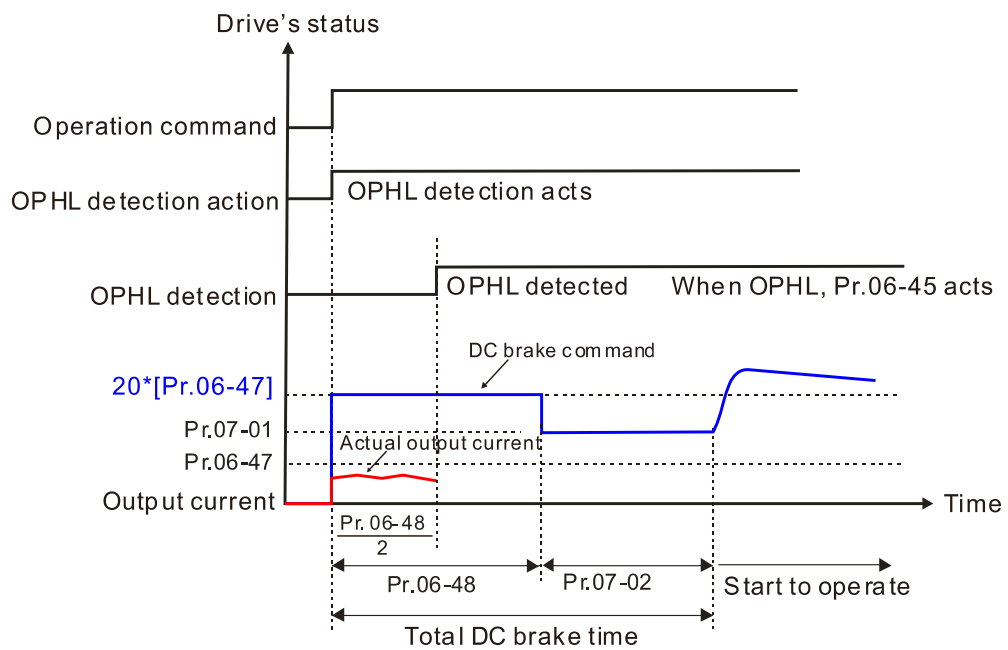

📖 Status 4: The drive is in STOP; Pr.06-48 ≠ 0; Pr.07-02 = 0

When the drive starts, it executes Pr.06-48 as the DC brake. The DC brake current level is 20 times the Pr.06-47 setting value. In this period, if an OPHL happens within the time for Pr.06-48, the drive executes the Pr.06-45 setting after the drive starts counting for half the time of Pr.06-48.

Status 4-1: Pr.06-48≠0, Pr.07-02=0 (No OPHL detected before operation)

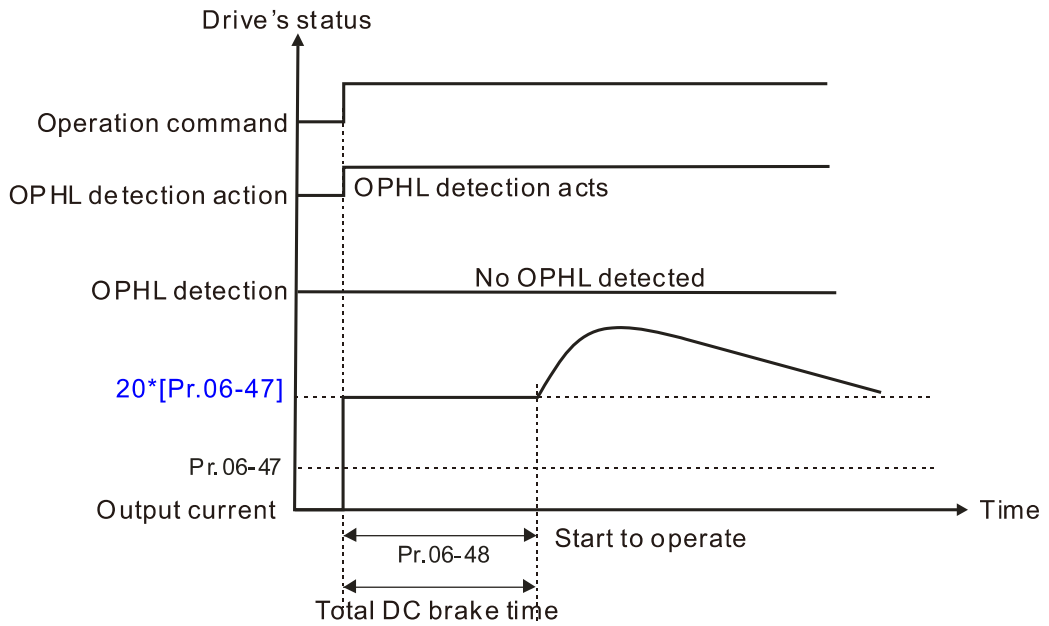

Status 4-2: Pr.06-48≠0, Pr.07-02=0 (OPHL detected before operation)

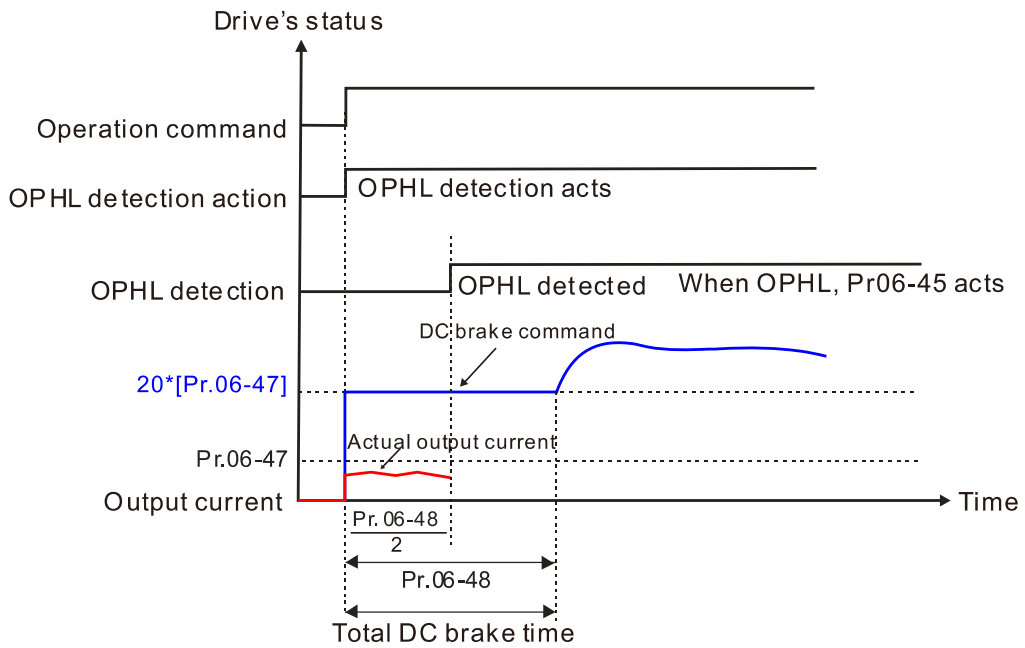

⚡ **06-49** LvX Auto-reset Default: 0

- Settings 0: Disable
1: Enable

⚡ **06-53** Detected Input Phase Loss Action (OrP) Default: 0

- Settings 0: Warn and ramp to stop
1: Warn and coast to stop

📖 The drive executes the input phase loss protection according to Pr.06-53.

06-55 Derating Protection

Default: 0

- Settings
- 0: Constant rated current and limit carrier wave by load current and temperature
 - 1: Constant carrier frequency and limit load current by setting carrier wave
 - 2: Constant rated current (same as setting 0), but close current limit

 Allowable maximum output frequency and the minimum carrier wave limit in control mode:

For VF and SVC modes:

When the maximum output frequency is 599 Hz, the minimum carrier wave is 6 k.

 Setting 0:

When the operating point is greater than the derating curve (when the operating carrier wave is greater than the rated carrier wave), the rated current is constant, and carrier frequency (F_c) output by the drive decreases automatically according to the ambient temperature, overload output current and overload time. If overloads are not frequent, and the concern is only about the carrier frequency operating with the rated current for a long time, and changes to the carrier wave due to short overload are acceptable, set to 0.

Refer to the following diagram for the level of carrier frequency. Take VFD9A0MH43ANSAA in normal duty for example: ambient temperature 50°C, 100% duty, UL open-type, and independent installation. When the carrier frequency is set to 10 kHz, it corresponds to 75% of the rated output current. When the output current is higher than this value, it automatically decreases the carrier wave according to the ambient temperature, output current and overload time. At this time, the overload capacity of the drive is still 150% of the rated current.

 Setting 1:

When the operating point exceeds derating curve 1, the carrier frequency is fixed to the set value. Select this mode if the change of carrier wave and motor noise caused by ambient temperature and frequent overload are not acceptable. Refer to Pr.00-17.

Refer to the following diagram for the derating level of the rated current. Take VFD9A0MH43ANSAA in normal duty for example, when the carrier frequency is to be maintained at 10 kHz, the rated current decreases to 75%. The OL protection executes when the current is $120\% \times 75\% = 90\%$ for one minute; therefore, it must operate by the curve to keep the carrier frequency.

 Setting 2:

The protection method and action are the same as setting it to 0, but this disables the current limit when output current is the derating ratio $\times 120\%$ (default value) in normal duty and is the derating ratio $\times 180\%$ (default value) in heavy duty.

The advantage is that this can provide a higher starting output current when the carrier frequency setting is higher than the default. The disadvantage is that the carrier wave derates easily when it overloads.

 Example:

When Pr.06-55 = 0 or 1, over-current stall prevention level = ratio * Pr.06-03. When Pr.06-55 = 2, the over-current stall prevention level = Pr.06-03. Use with the settings for Pr.00-16 and Pr.00-17.

The ambient temperature also affects the derating; refer to ambient temperature derating curve.

Example:

Take VFD9A0MH43ANSAA in normal duty for example: ambient temperature 50°C, UL open-type, and independent installation. When the carrier frequency is set to 10 kHz, it corresponds to 75% of the rated output current. The ambient temperature 60°C corresponds to 75% * 75% of the rated output current.

You can adjust the derating curve modulation mode (when Pr.00-10=0 and Pr.00-11=0-3) with Pr.11-41.

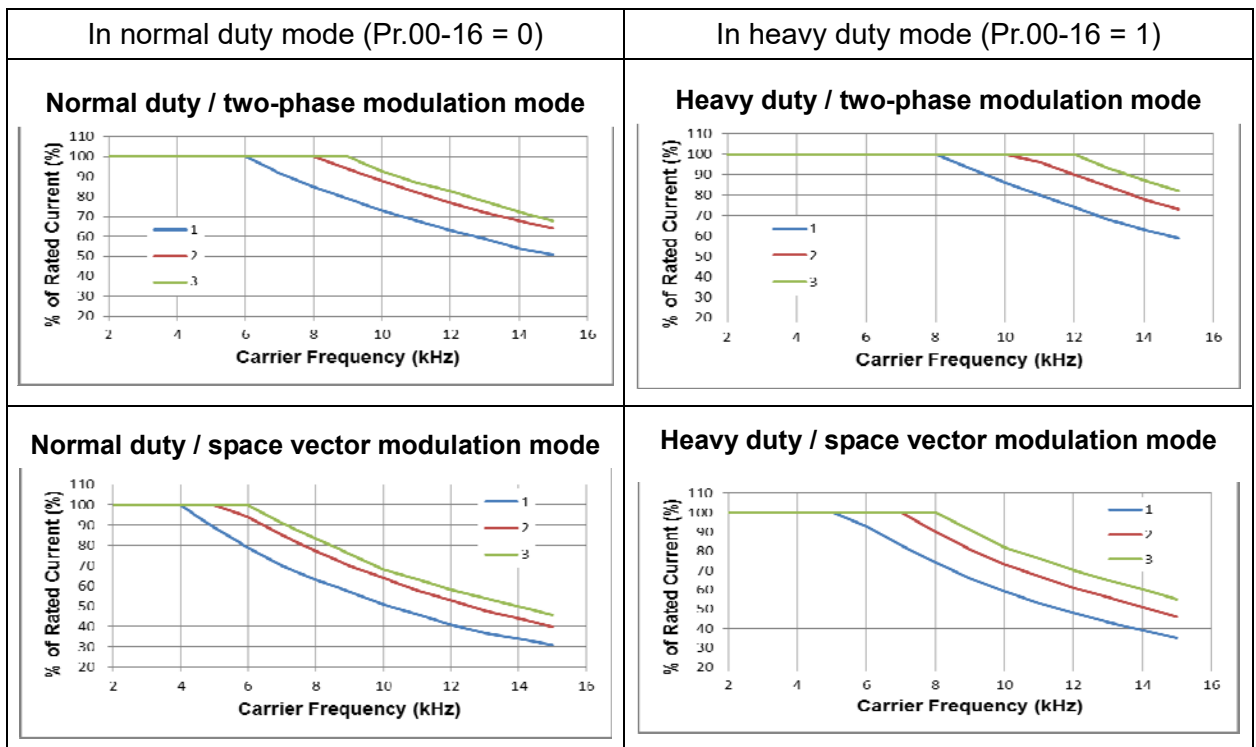

NOTE

Line 1: $T_a = 50^\circ\text{C}$ / Duty = 100%

Line 2: $T_a = 50^\circ\text{C}$ / Duty = 75% or $T_a = 40^\circ\text{C}$ / Duty = 100%

Line 3: $T_a = 50^\circ\text{C}$ / Duty = 50% or $T_a = 35^\circ\text{C}$ / Duty = 100%

Ambient temperature derating curve for general control

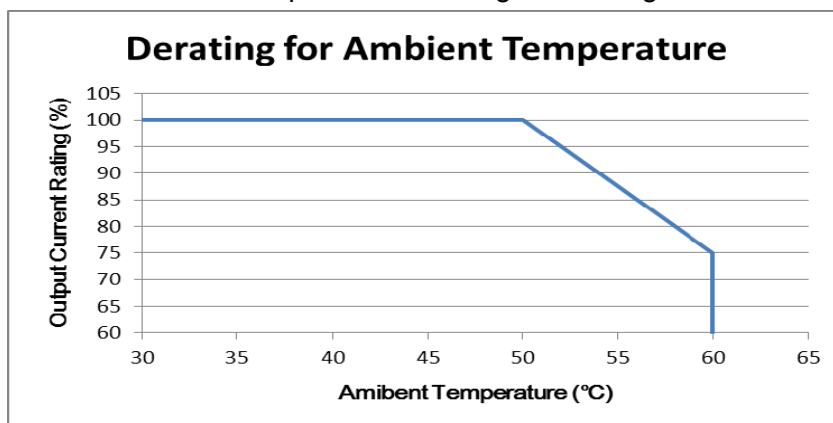

- ↗ **06-56** PT100 Voltage Level 1 Default: 5.000
 Settings 0.000–10.000 V
- ↗ **06-57** PT100 Voltage Level 2 Default: 7.000
 Settings 0.000–10.000 V
- 📖 Condition settings: Pr.06-57 > Pr.06-56.
- ↗ **06-58** PT100 Level 1 Frequency Protection Default: 0.00
 Settings 0.00–599.00 Hz
- ↗ **06-59** Delay Time for Activating PT100 Level 1 Frequency Protection Default: 60
 Settings 0–6000 sec.

📖 PT100 operation instructions

1. Use voltage type analog input (AVI voltage 0–10 V) and select PT100 mode.
2. When selecting Pr.03-00 = 11 and Pr.03-28 = 1, you must switch AFM to 0–10 V.
3. The AFM outputs constant voltage or current, then Pr.03-20 = 23. You must switch ACM to 0–20 mA, and set AFM output level to 45% (Pr.03-32 = 45%) of 20 mA = 9 mA.
4. Use Pr.03-32 to adjust the constant voltage or constant current of the AFM output; the setting range is 0–100.00%.
5. There are two types of action levels for PT100. The diagram below shows the PT100 protecting action.

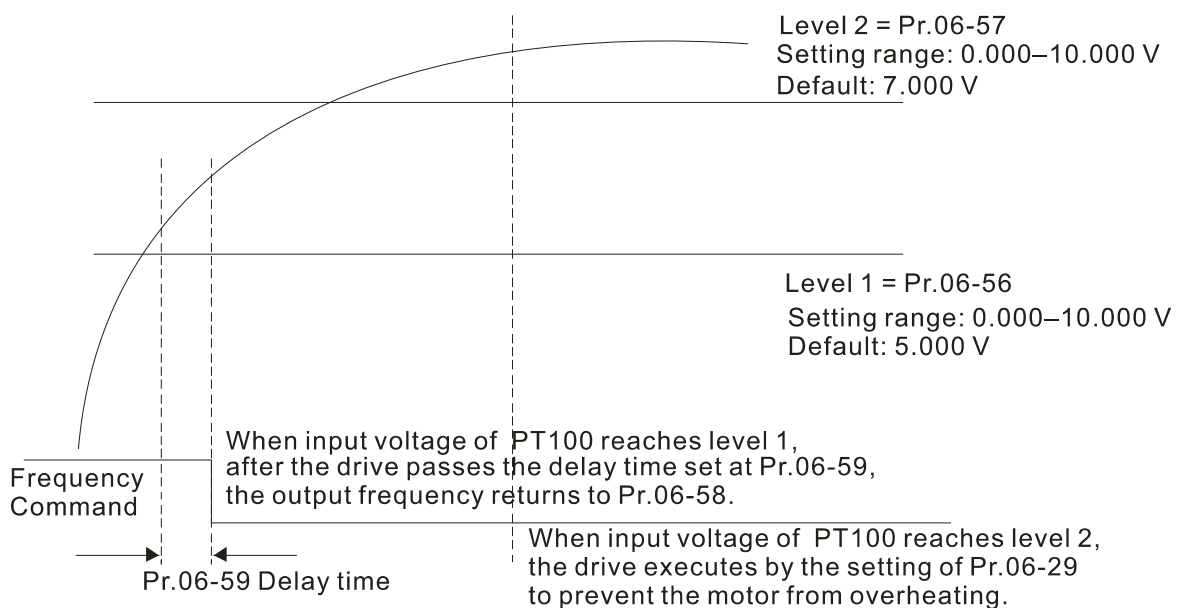

📖 When Pr.06-58 = 0.00 Hz, PT100 function is disabled.

Example:

When using PT100, if the motor temperature is higher than 135°C (275°F), the drive starts to count the delay time for auto-deceleration (Pr.06-59). The drive decreases the motor frequency to the setting for Pr.06-58 when it reaches the delay time count value. The drive operates at the frequency set for Pr.06-58 until the motor temperature is lower than 135°C (275°F). If the motor temperature is higher than 150°C (302°F), the drive automatically decelerates to STOP and displays the warning “OH3”.

Set up process:

1. Switch AFM to 0–20 mA on the control board.
2. Wiring:
 Connect external terminal AFM to “+”; Connect external terminal ACM to “-“
 Connect AFM and AVI to “short-circuit”
3. Pr.03-00 = 11, Pr.03-20 = 23, Pr.03-32 = 45% (9 mA)
4. Refer to the RTD temperature and resistance comparison table
 Temperature = 135°C, resistance = 151.71 Ω, input current: 9 mA, voltage: about 1.37 V_{DC}
 Temperature = 150°C, resistance = 157.33 Ω, input current: 9 mA, voltage: about 1.42 V_{DC}
5. When the RTD temperature > 135°C, the drive decelerates to the specified operation frequency automatically. Then, Pr.06-56 = 1.37 and Pr.06-58 = 10 Hz. When Pr.06-58 = 0, it disables the specified operation frequency.
6. When RTD temperature > 150°C, the drive outputs a fault, decelerates to STOP, and displays the warning “OH3”. Then, Pr.06-57 = 1.42 and Pr.06-29 = 1 (warn and ramp to stop).

↗	06-60	Software Detection GFF Current Level	Default: 60.0
---	--------------	--------------------------------------	---------------

Settings 0.0–6553.5%

↗	06-61	Software Detection GFF Filter Time	Default: 0.10
---	--------------	------------------------------------	---------------

Settings 0.00–655.35 sec.

When the drive detects that the unbalanced three-phase output current is higher than the setting for Pr.06-60, GFF protection activates. The drive then stops output.

	06-63	Operation Time of Fault Record 1 (Day)	
	06-65	Operation Time of Fault Record 2 (Day)	
	06-67	Operation Time of Fault Record 3 (Day)	
	06-69	Operation Time of Fault Record 4 (Day)	
	06-90	Operation Time of Fault Record 5 (Day)	
	06-92	Operation Time of Fault Record 6 (Day)	

Default: Read only

Settings 0–65535 days

06-64	Operation Time of Fault Record 1 (Min.)
06-66	Operation Time of Fault Record 2 (Min.)
06-68	Operation Time of Fault Record 3 (Min.)
06-70	Operation Time of Fault Record 4 (Min.)
06-91	Operation Time of Fault Record 5 (Min.)
06-93	Operation Time of Fault Record 6 (Min.)

Default: Read only

Settings 0–1439 min.

 If there is any malfunction when the drive operates, Pr.06-17–06-22 records the malfunctions, and Pr.06-63–06-70 records the operation time for four sequential malfunctions. Check if there is any problem with the drive according to the interval of the recorded fault.

Example:

The first error: ocA occurs after motor drive operates for 1000 minutes.

The second error: ocd occurs after another 1000 minutes.

The third error: ocn occurs after another 1000 minutes.

The fourth error: ocA occurs after another 1000 minutes.

The fifth error: ocd occurs after another 1000 minutes.

The sixth error: ocn occurs after another 1000 minutes.

Then Pr.06-17–06-22 and Pr.06-63–06-70 are recorded as follows:

	1 st fault	2 nd fault	3 rd fault	4 th fault	5 th fault	6 th fault
Pr.06-17	ocA	ocd	ocn	ocA	ocd	ocn
Pr.06-18	0	ocA	ocd	ocn	ocA	ocd
Pr.06-19	0	0	ocA	ocd	ocn	ocA
Pr.06-20	0	0	0	ocA	ocd	ocn
Pr.06-21	0	0	0	0	ocA	ocd
Pr.06-22	0	0	0	0	0	ocA
Pr.06-63	1000	560	120	1120	680	240
Pr.06-64	0	1	2	2	3	4
Pr.06-65	0	1000	560	120	1120	680
Pr.06-66	0	0	1	2	2	3
Pr.06-67	0	0	1000	560	120	1120
Pr.06-68	0	0	0	1	2	2
Pr.06-69	0	0	0	1000	560	120
Pr.06-70	0	0	0	0	1	2

※ By examining the time record, you can see that that the last fault (Pr.06-17) happened after the drive ran for 4 days and 240 minutes.

06-71 Low Current Setting Level

Default: 0.0

Settings 0.0–100.0%

↗ **06-72** Low Current Detection Time

Default: 0.00

Settings 0.00–360.00 sec.

↗ **06-73** Low Current Action

Default: 0

Settings 0 : No function

1 : Warn and coast to stop

2 : Warn and ramp to stop by the second deceleration time

3 : Warn and continue operation

📖 The drive operates according to the setting for Pr.06-73 when the output current is lower than the setting for Pr.06-71 and when the time of the low current exceeds the detection time for Pr.06-72.

Use this parameter with the external multi-function output terminal 44 (for low current output).

📖 The low current detection function does not execute when drive is in sleep or standby status.

07 Special Parameters

✎ You can set this parameter during operation.

✎ 07-00 Software Brake Level

Default:

Settings	115V / 230V: 350.0–450.0 V _{DC}	370.0
	460V: 700.0–900.0 V _{DC}	740.0

📖 Sets the brake transistor level for the DC BUS voltage. Choose a suitable brake resistor to achieve the best deceleration. Refer to Chapter 7 Optional Accessories for information about brake resistors.

✎ 07-01 DC Brake Current Level

Default: 0

Settings 0–100%

📖 Sets the level of the DC brake current output to the motor during start-up and stop. When you set the DC brake current percentage, the rated current is regarded as 100%. Start with a low DC brake current level, and increase it slowly until the proper brake torque is reached. However, to avoid burning the motor, the DC brake current can NOT exceed the rated current. Therefore, DO NOT use the DC brake for mechanical retention, otherwise injury or accident may occur.

✎ 07-02 DC Brake Time at RUN

Default: 0.0

Settings 0.0–60.0 sec.

📖 The motor may continue rotating after the drive stops output due to external forces or the inertia of the motor itself. If you use the drive with the motor rotating, it may cause motor damage or trigger drive protection due to over-current. This parameter outputs DC current, generating torque to force the motor stop to get a stable start before motor operation. This parameter determines the duration of the DC brake current output to the motor when the drive starts up. Setting this parameter to 0.0 disables the DC brake at start-up.

✎ 07-03 DC Brake Time at STOP

Default: 0.0

Settings 0.0–60.0 sec.

📖 The motor may continue rotating after the drive stops output due to external forces or the inertia of the motor itself. This parameter outputs DC current, generating torque to force the drive stop after the drive stops output to make sure that the motor stops.

📖 This parameter determines the duration of the DC Brake current output to the motor when braking. To enable DC brake at STOP, set Pr.00-22 (Stop Method) to 0 (ramp to stop).

📖 Related parameters: Pr.00-22 Stop Method, Pr.07-04 DC Brake Frequency at Start

07-04 DC Brake Frequency at STOP

Default: 0.00

Settings 0.00–599.00 Hz

This parameter determines the start frequency of the DC brake before the drive ramps to stop. When this setting is less than Pr.01-09 (Start-up Frequency), the start frequency of the DC brake starts from the minimum frequency.

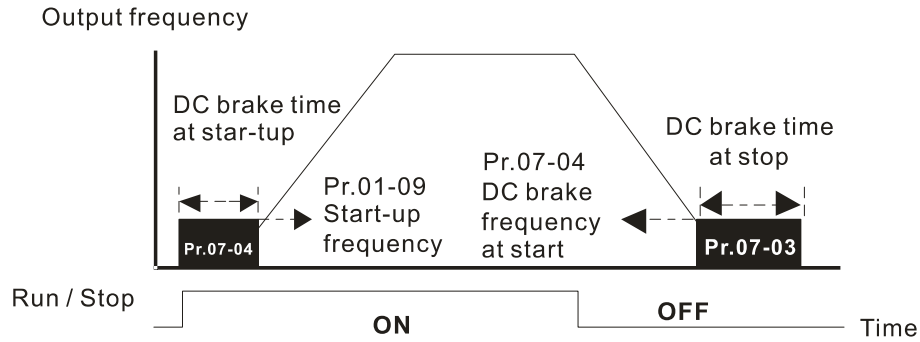

DC Brake Output Timing Diagram

Use the DC brake before running the motor when the load is movable at stop, such as with fans and pumps. The motor is in free operating status and in unknown rotation direction before the drive starts up. Execute the DC brake before you start the motor.

Use DC Brake at STOP when you need to brake the motor quickly or to control the positioning, such as with cranes or cutting machines.

07-05 Voltage Increasing Gain

Default: 100

Settings 1–200%

When using speed tracking, adjust Pr.07-05 to slow down the increasing voltage gain if there are errors such as oL or oc; however, the speed tracking time will be longer.

07-06 Restart after Momentary Power Loss

Default: 0

Settings 0: Stop operation

1: Speed tracking by the speed before the power loss

2: Speed tracking by the minimum output frequency

Determines the operation mode when the drive restarts from a momentary power loss.

The power system connected to the drive may power off momentarily for many reasons. This function allows the drive to keep outputting after the drive is repowered and does not cause the drive to stop.

1: Frequency tracking begins before momentary power loss and accelerates to the master Frequency command after the drive output frequency and motor rotator speed are synchronous. Use this setting when there is a lot of inertia with little resistance on the motor load. For example, in equipment with a large inertia flywheel, there is NO need to wait until the flywheel stops completely after a restart to execute the operation command; therefore, it saves time.

- 2: Frequency tracking starts from the minimum output frequency and accelerates to the master Frequency command after the drive output frequency and motor rotator speed are synchronous. Use this setting when there is little inertia and large resistance.

07-07 Allowed Power Loss Duration

Default: 2.0

Settings 0.0–20.0 sec.

- Determines the maximum time of allowable power loss. If the duration of a power loss exceeds this parameter setting, the AC motor drive stops output.
- Pr.07-06 is valid when the maximum allowable power loss time is ≤ 20 seconds and the AC motor drive displays “LV”. If the AC motor drive is powered off due to overload, even if the maximum allowable power loss time is ≤ 20 seconds, the operation mode set in Pr.07-06 does not execute.

07-08 Base Block Time

Default: 0.5

Settings 0.1–5.0 sec.

- When momentary power loss is detected, the AC motor drive blocks its output and then waits for a specified period of time (determined by Pr.07-08, called Base Block Time) before resuming operation. Set this parameter to the time that allows the residual voltage at the output side to decrease to 0 V before activating the drive again.

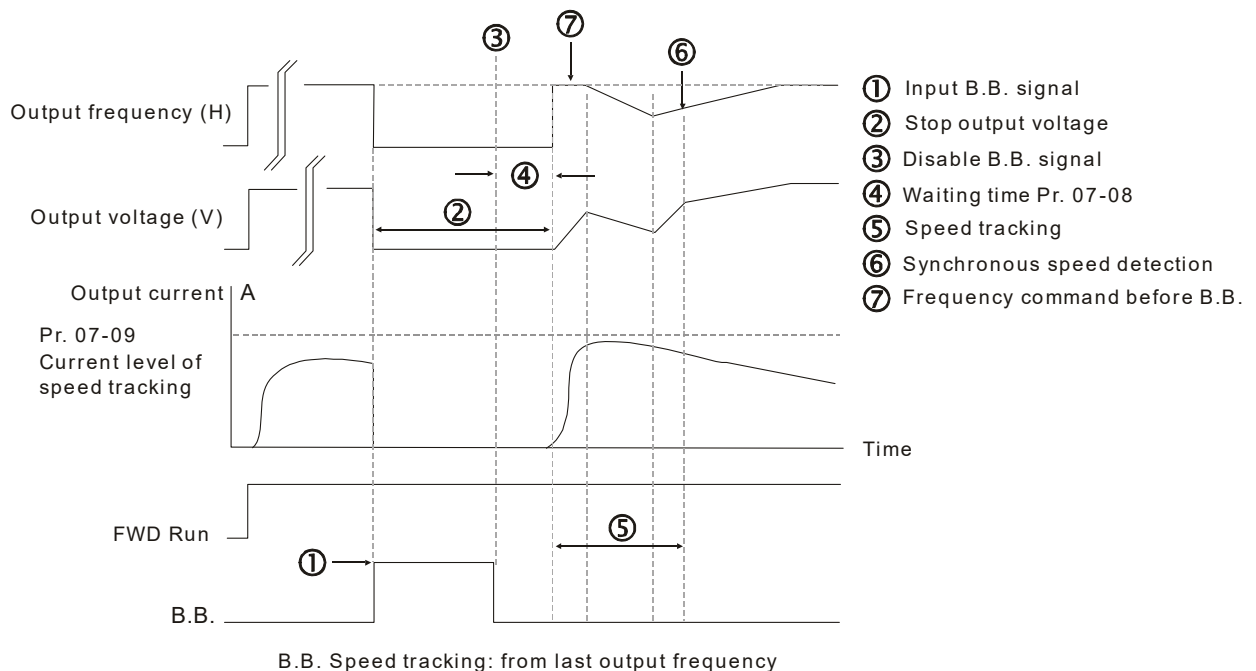

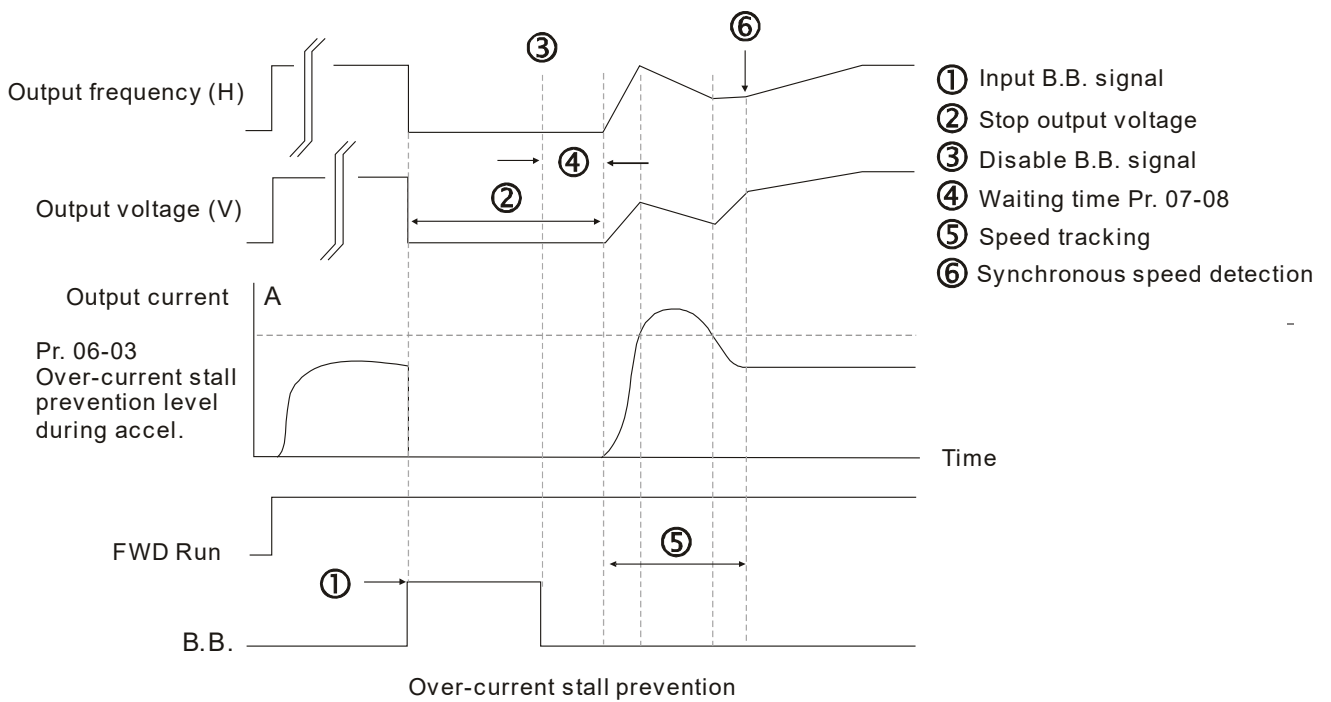
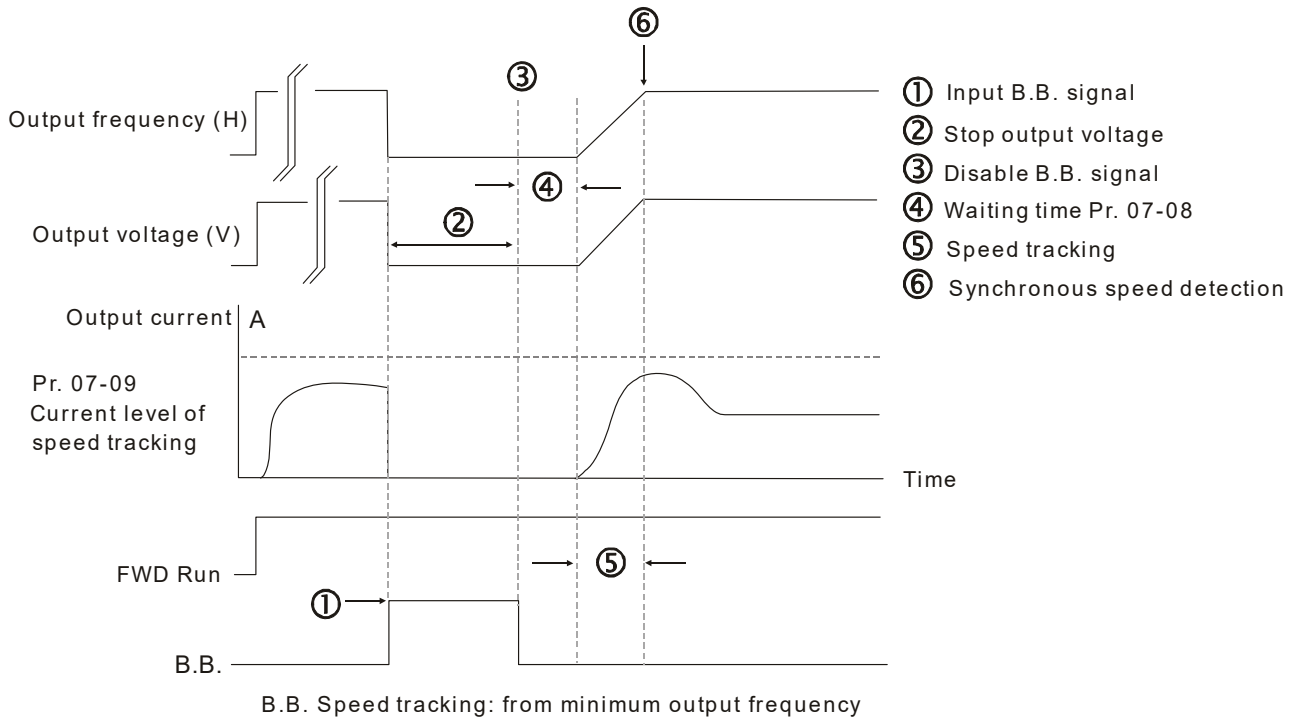

07-09 Current Limit of Speed Tracking

Default: 100

Settings 20–200%

- 📖 The AC motor drive executes speed tracking only if the output current is greater than the value set in Pr.07-09.
- 📖 The maximum current for speed tracking affects the synchronous time. The larger the parameter setting is, the faster the synchronization occurs. However, if the parameter setting is too large, the overload protection function may be activated.

07-10 Restart after Fault Action

Default: 0

- Settings
- 0: Stop operation
 - 1: Speed tracking by current speed
 - 2: Speed tracking by minimum output frequency

 In PG control mode, the AC motor drive executes the speed tracking function automatically according to the PG speed when this setting is NOT set to 0.

 Faults include: bb, oc, ov, occ. To restart after oc, ov, occ, you can NOT set Pr.07-11 to 0.

07-11 Number of Times of Auto-restart after Fault

Default: 0

- Settings 0–10

 After fault (allowed fault: oc, ov, occ) occurs, the AC motor drive can reset and restart automatically up to 10 times.

 If the number of faults exceeds the Pr.07-11 setting, the drive does not reset and restart until you press “RESET” manually and execute the operation command again.

07-12 Speed Tracking during Start-up

Default: 0

- Settings
- 0: Disable
 - 1: Speed tracking by maximum output frequency
 - 2: Speed tracking by motor frequency at start
 - 3: Speed tracking by minimum output frequency

 Speed tracking is suitable for punch, fans and other large inertia loads. For example, a mechanical punch usually has a large inertia flywheel, and the general stop method is coast to stop. If it needs to be restarted again, the flywheel may take 2–5 minutes or longer to stop. This parameter setting allows you to start the flywheel operating again without waiting until the flywheel stops completely.

07-13 dEb Function Selection

Default: 0

- Settings
- 0: Disable
 - 1: dEb with auto-acceleration/auto-deceleration, the drive does not output the frequency after the power is restored.
 - 2: dEb with auto-acceleration/ auto-deceleration, the drive outputs the frequency after the power is restored.

 dEb (Deceleration Energy Backup) lets the motor decelerate to stop when momentary power loss occurs. When the power loss is instantaneous, use this function to let the motor decelerate to zero speed. If the power recovers at this time, the drive restarts the motor after the dEb return time.

 Lv return level: Default value depends on the drive power model.

Frame A, B, C, D = Pr.06-00 + 60 V / 30 V (220V series)

Frame E and above = Pr.06-00 + 80 V / 40 V (220V series)

- 📖 Lv level: Default is Pr.06-00.
- 📖 During dEb operation, other protection, such as ryF, ov, oc, occ, and EF may interrupt it, and these error codes are recorded.
- 📖 The STOP (RESET) command does not work during the dEb auto-deceleration, and the drive continues decelerating to stop. To make the drive coast to stop immediately, use another function (EF) instead.
- 📖 The B.B. function does not work when executing dEb. The B.B. function is enabled after the dEb function finishes.
- 📖 Even though the Lv warning does not display during dEb operation, if the DC BUS voltage is lower than the Lv level, MO = 10 (Low voltage warning) still operates.
- 📖 The following explains the dEb action:
When the DC voltage drops below the dEb setting level, the dEb function starts to work (soft start relay remains closed), and the drive executes auto-deceleration.

- **Situation 1:** Momentary power loss, or power current too low and unstable, or power supply sliding down because of sudden heavy load.
Pr.07-13 = 1 and power recovers.

When the power recovers and DC BUS voltage exceeds the dEb return level, the drive linearly decelerates to 0 Hz and stops. The keypad displays the "dEb" warning until you manually reset it, so that you can see the reason for the stop.

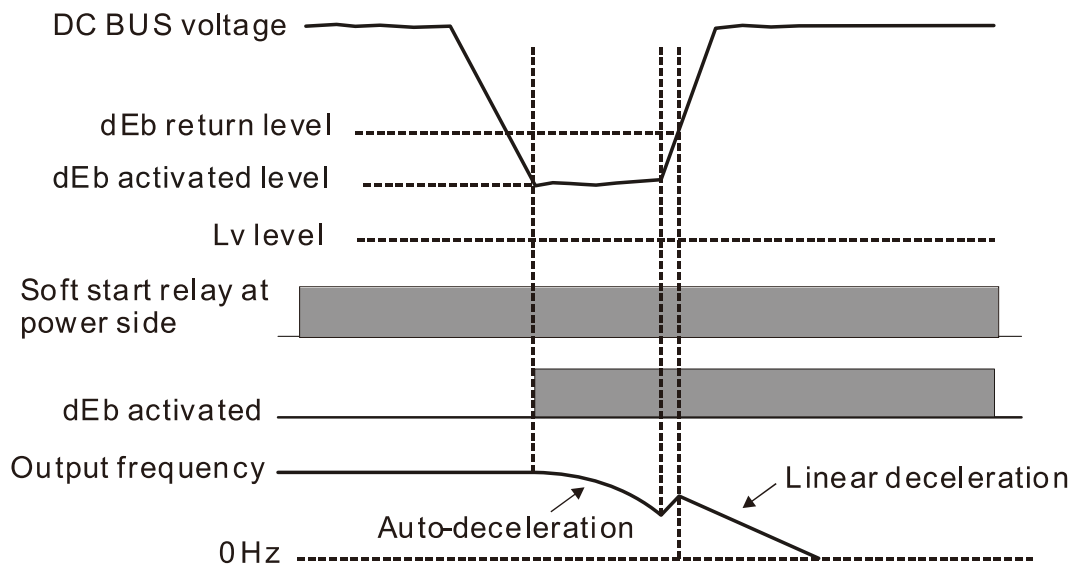

- **Situation 2:** Momentary power loss, or power current too low and unstable, or power supply sliding down because of sudden heavy load.
Pr.07-13 = 2 and power recovers.

During the dEb deceleration (includes 0 Hz run), if the power recovers higher than dEb return level, the drive maintains the frequency for three seconds and then accelerates again. The dEb warning on the keypad clears automatically.

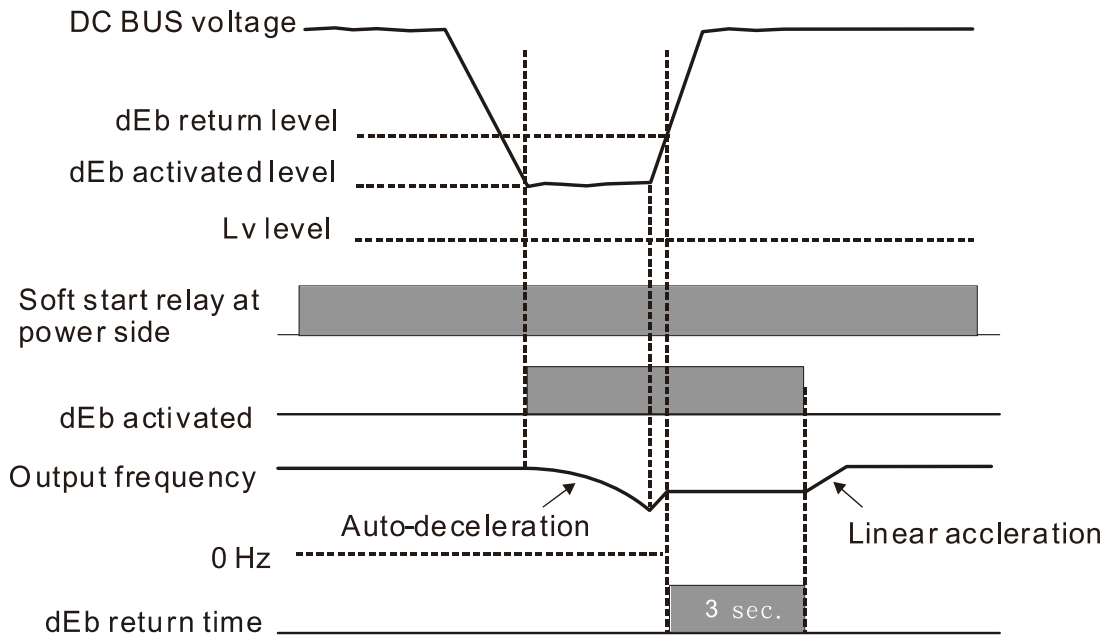

- **Situation 3:** Power supply unexpected shut down or power loss.

Pr.07-13 = 1 and power does not recover.

The keypad displays the “dEb” warning and stops after decelerating to the lowest running frequency. When the DC BUS voltage is lower than the Lv level, the drive disconnects the soft start relay until the power completely runs out.

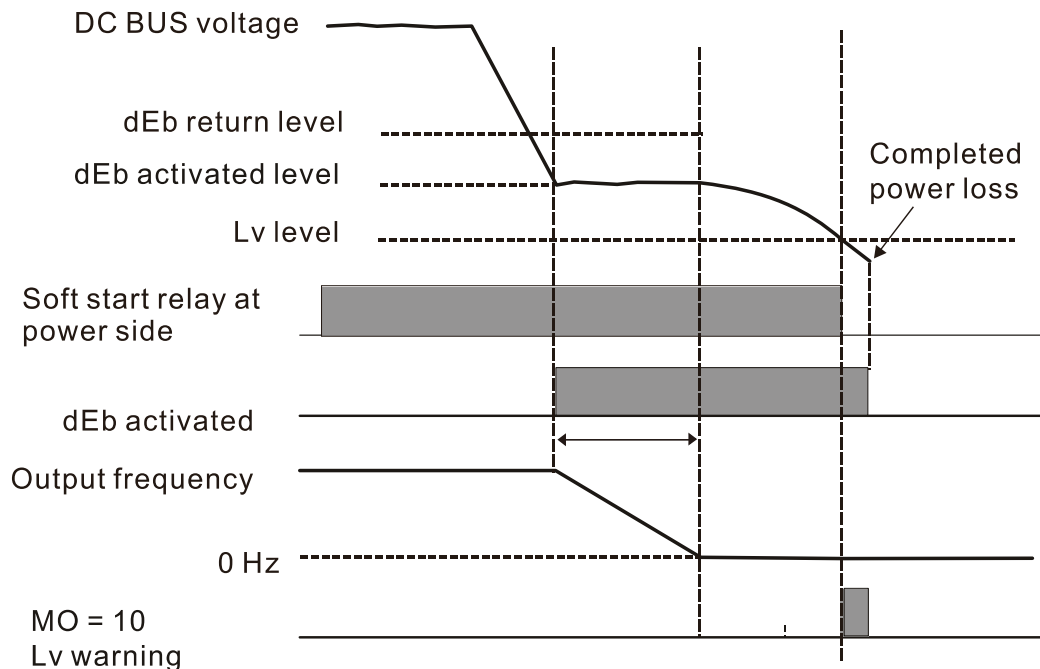

- **Situation 4:** Power supply unexpected shut down or power loss.

Pr.07-13 = 2 and power does not recover.

The drive decelerates to 0 Hz. The DC BUS voltage continues to decrease until the voltage is lower than the Lv level, and then the drive disconnects the soft start relay. The keypad displays “dEb” warning until the drive completely runs out of power.

- Situation 5:** Pr.07-13 = 2 and power recovers after the DC BUS voltage is lower than the Lv level. The drive decelerates to 0 Hz. The DC BUS voltage continues to decrease until the voltage is lower than the Lv level, and then the drive disconnects the soft start relay. The soft start relay closes again after the power recovers and the DC BUS voltage is higher than the Lv return level. When the DC BUS voltage is higher than the dEb return level, the drive maintains the frequency for three seconds and starts to accelerate linearly, and the dEb warning on the keypad clears automatically.

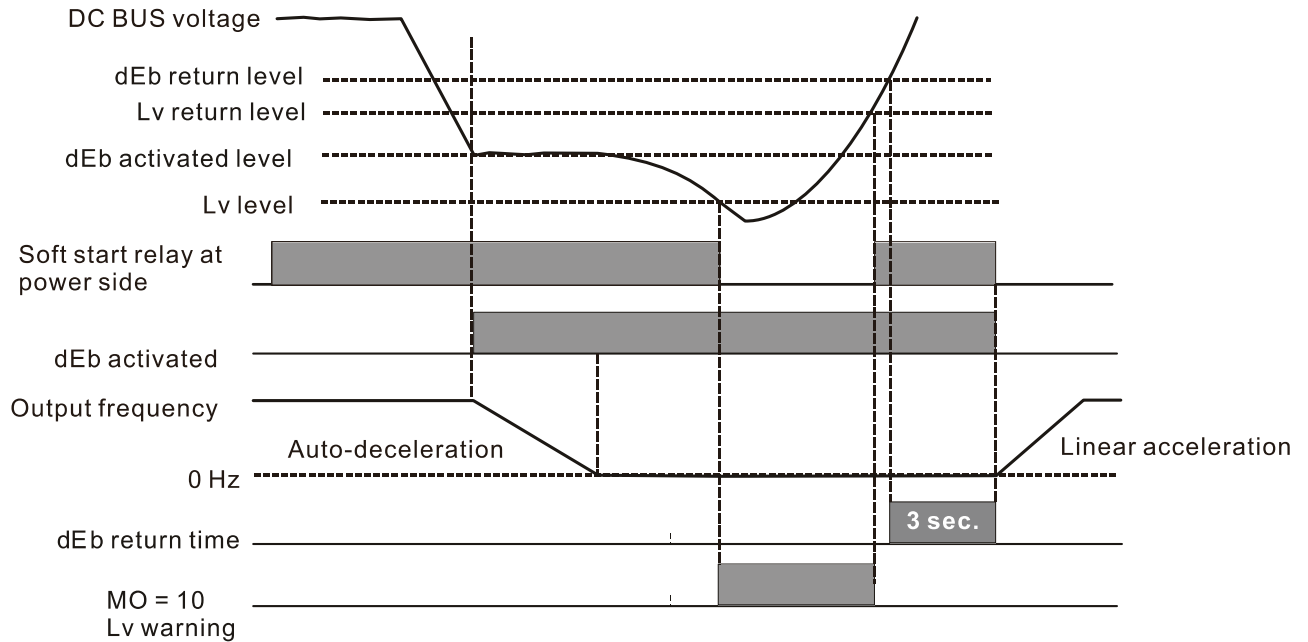

↗ **07-15** Dwell Time at Acceleration Default: 0.00

Settings 0.00–600.00 sec.

↗ **07-17** Dwell Time at Deceleration Default: 0.00

Settings 0.00–600.00 sec.

↗ **07-16** Dwell Frequency at Acceleration Default: 0.00

Settings 0.00–599.00 Hz

↗ **07-18** Dwell Frequency at Deceleration Default: 0.00

Settings 0.00–599.00 Hz

📖 In heavy load situations, the Dwell temporarily maintains stable output frequency. Use this parameter for cranes, elevators, and so on.

📖 When the load is heavier, use Pr.07-15–Pr.07-18 to avoid OV or OC protection.

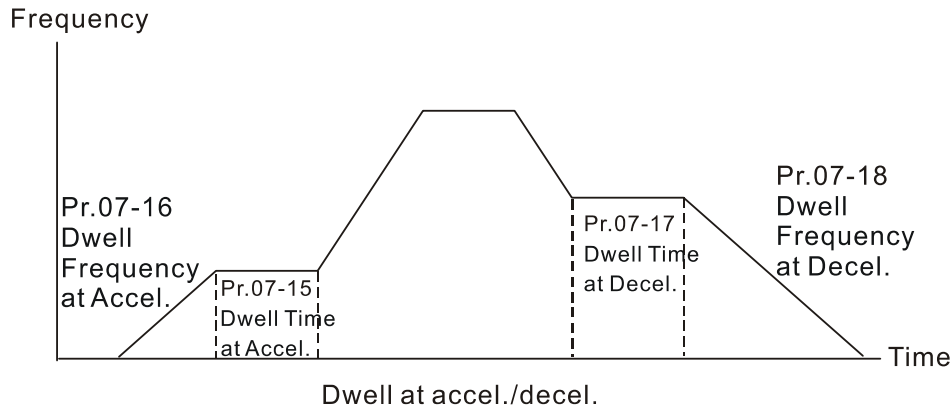

07-19 Fan Cooling Control

Default: 3

- Settings
- 0: Fan always ON
 - 1: Fan is OFF after the AC motor drive stops for one minute.
 - 2: When the AC motor drive runs, the fan is ON. When the AC motor drive stops, the fan is OFF.
 - 3: Fan turns ON when the temperature reaches around 60°C
 - 5: Fan turns ON/OFF when the AC motor drive runs/stops and stops at zero speed.

Use this parameter to control the fan.

0: Fan runs immediately when the drive power is turned ON.

1: Fan runs when AC motor drive runs. One minute after AC motor drive stops, the fan is OFF.

2: Fan runs when AC motor drive runs and stops immediately when AC motor drive stops.

3: When temperature of the IGBT or capacitance is higher than 60°C, the fan runs.

When the temperature of the IGBT and capacitance both are lower than 40°C, the fan stops.

07-20 Deceleration of Emergency or Forced Stop

Default: 0

- Settings
- 0: Coast to stop
 - 1: Stop by the first deceleration time
 - 2: Stop by the second deceleration time
 - 3: Stop by the third deceleration time
 - 4: Stop by the fourth deceleration time
 - 5: System deceleration
 - 6: Automatic deceleration

When the multi-function input terminal is set to EF input (setting 10) or forced to stop (setting 18) and the terminal contact is ON, the drive stops according to the setting of this parameter.

07-21 Automatic Energy-saving Setting

Default: 0

- Settings
- 0: Disable
 - 1: Enable

When energy-saving is enabled, the motor acceleration operates with full voltage. During

constant speed operation, it automatically calculates the best voltage value according to the load power. This function is not suitable for fluctuating loads or loads which are nearly full during operation.

- 📖 When the output frequency is constant (that is, constant operation), the output voltage decreases automatically as the load decreases. Therefore, the drive operates with minimum multiplication of voltage and current (electric power).

↗ **07-22** Energy-saving Gain

Default: 100

Settings 10–1000%

- 📖 When Pr.07-21 is set to 1, use this parameter to adjust the energy-saving gain. The default is 100%. If the result is not satisfactory, adjust it by decreasing the setting value. If the motor oscillates, then increase the setting value.
- 📖 In certain applications such as high speed spindles, the temperature rise in the motor is a major concern. When the motor is not in working state, reduce the motor current to a lower level. Reduce this parameter setting to meet this requirement.

↗ **07-23** Auto Voltage Regulation (AVR) Function

Default: 0

Settings 0: Enable AVR
1: Disable AVR
2: Disable AVR during deceleration

- 📖 The rated voltage of a 220V motor is usually AC 200 V, 60 Hz / 50 Hz, and the input voltage of the AC motor drive may vary from AC 180 V to 264 V, 50 Hz / 60 Hz. Therefore, when the AC motor drive is used without the AVR function, the output voltage is the same as the input voltage. When the motor runs at the voltage exceeding 12–20% of the rated voltage, it causes higher temperatures, damaged insulation, and unstable torque output, which result in losses due to shorter motor lifetime.
- 📖 The AVR function automatically regulates the output voltage of the AC motor drive to the motor rated voltage. For example, if the V/F curve is set at AC 200 V, 50 Hz and the input voltage is at AC 200–264 V, then the drive automatically reduces the output voltage to the motor to a maximum of AC 200 V, 50 Hz. If the input voltage is at AC 180–200 V, the output voltage to motor and input power are in direct proportion.
- 📖 0: When the AVR function is enabled, the drive calculates the output voltage according to the actual DC BUS voltage. The output voltage does NOT change when the DC BUS voltage changes.
- 📖 1: When the AVR function is disabled, the drive calculates the output voltage according to the actual DC BUS voltage. The DC BUS voltage changes the output voltage, and may cause insufficient or over-current or shock.
- 📖 2: The drive disables the AVR function when decelerating to stop, and may accelerate to brake.
- 📖 When the motor ramps to stop, the deceleration time is shorter when setting this parameter to 2 with auto-acceleration and deceleration, and the deceleration is quicker and more stable.

07-24 Torque Command Filter Time (V/F and SVC Control Mode)

Default: 0.050

Settings 0.001–10.000 sec.

- 📖 When the setting is too long, the control is stable but the control response is delayed. When the setting is too short, the response is quicker but the control may be unstable. Adjust the setting according to the stability of the control and response times.

07-25 Slip Compensation Filter Time (V/F and SVC Control Mode)

Default: 0.100

Settings 0.001–10.000 sec.

- 📖 Change the compensation response time with Pr.07-24 and Pr.07-25.
- 📖 If you set Pr.07-24 and Pr.07-25 to 10 seconds, the compensation response time is the slowest; however, the system may be unstable if you set the time too short.

07-26 Torque Compensation Gain

07-71 Torque Compensation Gain (Motor 2)

Default: 1

Settings IM: 0–10 (when Pr.05-33 = 0)

PM: 0–5000 (when Pr.05-33 = 1 or 2)

- 📖 With a large motor load, a part of drive output voltage is absorbed by the stator winding resistor; therefore, the air gap magnetic field is insufficient. This causes insufficient voltage at motor induction and results in excessive output current but insufficient output torque. Auto-torque compensation can automatically adjust the output voltage according to the load and keep the air gap magnetic fields stable to get the optimal operation.
- 📖 In the V/F control, the voltage decreases in direct proportion with decreasing frequency. It reduces the torque decrease at low speed due to the AC while the DC resistor is unchanged. The auto-torque compensation function increases the output voltage at low frequency to get a higher starting torque.
- 📖 When the compensation gain is set too high, it may cause motor over-flux and result in a too large output current, overheating the motor or triggering the protection function.

07-27 Slip Compensation Gain (V/F and SVC Control Mode)

07-72 Slip Compensation Gain (Motor 2)

Default: 0.00

Settings 0.00–10.00

(Default value is 1 in SVC mode)

- 📖 The induction motor needs constant slip to produce magnetic torque. It can be ignored at higher motor speeds, such as rated speed or 2–3% of slip.
- 📖 In operation, the slip and the synchronous frequency are in reverse proportion to produce the same magnetic torque. The slip is larger with the reduction of the synchronous frequency. The motor may stop when the synchronous frequency decreases to a specific value. Therefore, the slip seriously affects the motor speed accuracy at low speed.
- 📖 In another situation, when you use an induction motor with the drive, the slip increases when the load increases. It also affects the motor speed accuracy.

 Use this parameter to set the compensation frequency, and reduce the slip to maintain the synchronous speed when the motor runs at the rated current in order to improve the accuracy of the drive. When the drive output current is higher than Pr.05-05 (No-load Current of Induction Motor 1 (A)), the drive compensates the frequency with this parameter.

 This parameter is set to 1.00 automatically when Pr.00-11 (Speed Control Method) is changed from V/F mode to vector mode. Apply the slip compensation after load and acceleration. Increase the compensation value from small to large gradually; add the output frequency with motor rated slip * Pr.07-27 (Slip Compensation Gain) when the motor is at the rated load. If the actual speed ratio is slower than expected, increase the parameter setting value; otherwise, decrease the setting value.

07-29 Slip Deviation Level Default: 0

Settings 0.0–100.0%
0: No detection

07-30 Slip Deviation Detection Time Default: 1.0

Settings 0.0–10.0 sec.

07-31 Slip Deviation Action Default: 0

Settings 0: Warn and continue operation
1: Warn and ramp to stop
2: Warn and coast to stop
3: No warning

 Parameters Pr.07-29–Pr.07-31 set the allowable slip level/time and the over-slip action when the drive is running.

07-32 Motor Shock Compensation Factor Default: 1000

Settings 0–10000

 If there are current wave motions in the motor in some specific area, setting this parameter can effectively improve this situation. When running with high frequency or PG, set this parameter to 0. When the current wave motion occurs in low frequency and high-power, increase the value for Pr.07-32.

07-33 Auto-restart Interval of Fault Default: 60.0

Settings 0.0–6000.0 sec.

 When a reset/restart occurs after a fault, the drive uses Pr.07-33 as a timer and starts counting the number of faults within this time period. Within this period, if the number of faults does not exceed the setting for Pr.07-11, the counting clears and starts from 0 when the next fault occurs.

07-43 Average PWM Signal

Default: 1

Settings 1–100 times

- This parameter calculates the corresponding frequency command based on the average values according to the set number of times for PWM signal period. The smaller the number of times set, the faster the frequency changes.

07-44 PWM Signal Period

Default: 1

Settings 1–2000 ms

- Sets the period for PWM signal input.
- ME300 can control the operation frequency of the drive through PWM/pulse signal outputted from devices such as PLC; however, PWM signal can only be input from MI5. You must set the Master frequency command (AUTO) source Pr.00-20 to 4 (Pulse input without direction command) and set pulse input type Pr.10-16 to 6 (PWM signal input). Pr.07-43 sets how long the PWM outputs a command after how many times of averaging and sets the period of external PWM. The corresponding output frequency calculates according to the settings for these two parameters.
- When the actual input PWM pulse signal period is different from Pr.07-44 setting, the output frequency calculates incorrectly.
- The relationship between PWM signal and frequency command shows as the diagram below:

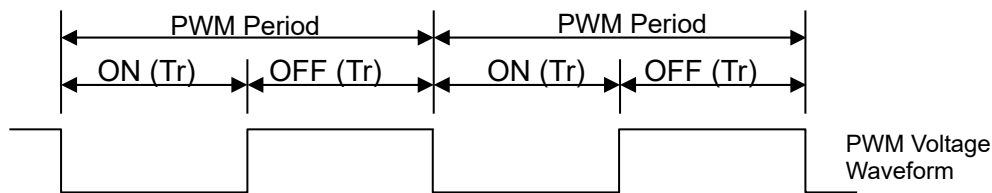

Frequency command value (Hz) = (ON time / PWM period) x the maximum output frequency (Hz)

07-62 dEb Gain

Default: 8000

Settings 0–65535

[This page intentionally left blank]

08 High-function PID Parameters

✎ You can set this parameter during operation.

✎ 08-00 Terminal Selection of PID Feedback

Default: 0

- Settings
- 0: No function
 - 1: Negative PID feedback: by analog input (Pr.03-00)
 - 4: Positive PID feedback: by analog input (Pr.03-00)
 - 7: Negative PID feedback: by communication protocol
 - 8: Positive PID feedback: by communication protocol

📖 Negative feedback means:

+ target value – feedback. The detection value increases by increasing the output frequency.

📖 Positive feedback means:

- target value + feedback. The detection value decreases by increasing the output frequency.

📖 When Pr.08-00 ≠ 7 neither ≠ 8, the input value is disabled. The value of the setting does not remain the same after the drive is off.

1. Common applications for PID control:

- Flow control: Use a flow sensor to feedback the flow data and perform accurate flow control.
- Pressure control: Use a pressure sensor to feedback the pressure data and perform precise pressure control.
- Air volume control: Use an air volume sensor to feedback the air volume data to achieve excellent air volume regulation.
- Temperature control: Use a thermocouple or thermistor to feedback temperature data for comfortable temperature control.
- Speed control: Use a speed sensor or encoder to feedback motor shaft speed or input another machine speed as a target value for closed loop speed control of the master-slave operation.

2. PID control loop:

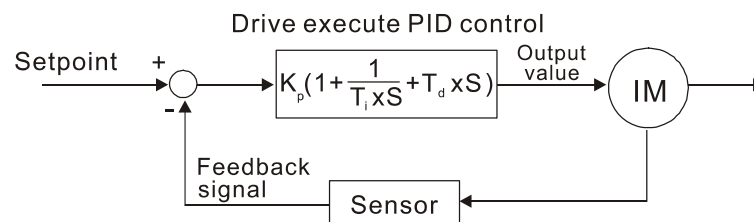

3. Concept of PID control:

Proportional gain (P):

The output is proportional to input. With only proportional gain control, there is always a steady-state error.

Integral time (I):

The controller output is proportional to the integral of the controller input. To eliminate the steady-state error, add an “integral part” to the controller. The integral time controls the relation between the integral part and the error. The integral part increases over time even if the error is

small. It gradually increases the controller output to eliminate the error until it is zero. This stabilizes the system without a steady-state error by using proportional gain control and integral time control.

Differential control (D):

The controller output is proportional to the differential of the controller input. During elimination of the error, oscillation or instability may occur. Use the differential control to suppress these effects by acting before the error. That is, when the error is near 0, the differential control should be 0. Use proportional gain (P) and differential control (D) to improve the system state during PID adjustment.

4. Using PID control in a constant pressure pump feedback application:

Set the application's constant pressure value (bar) to be the set point of PID control. The pressure sensor sends the actual value as the PID feedback value. After comparing the PID set point and PID feedback, an error displays. The PID controller calculates the output by using proportional gain (P), integral time (I) and differential time (D) to control the pump. It controls the drive to use a different pump speed and achieves constant pressure control by using a 4–20 mA signal corresponding to 0–10 bar as feedback to the drive. A–b

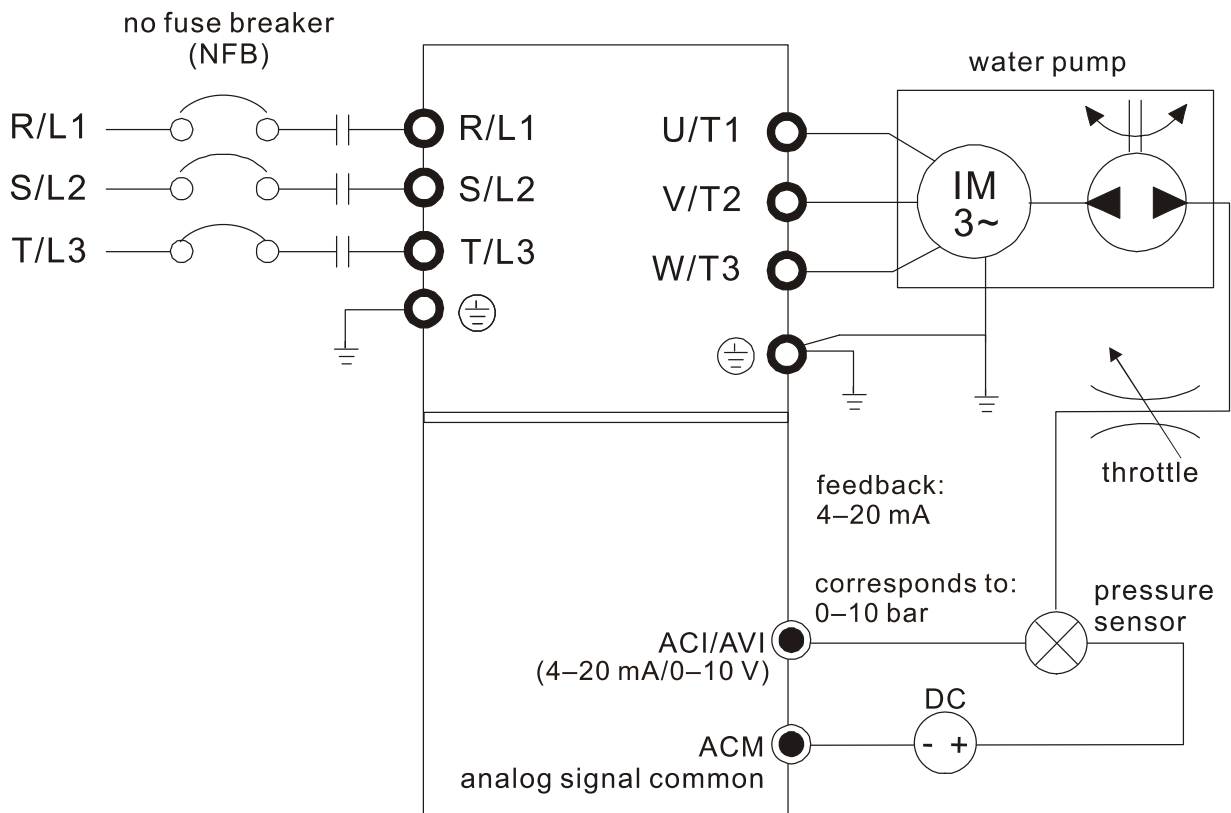

- Pr.00-04 = 10 (display PID feedback (b) (%))
- Pr.01-12 Acceleration Time is set according to actual conditions.
- Pr.01-13 Deceleration Time is set according to actual conditions.
- Pr.00-21 = 0 to operate through the digital keypad
- Pr.00-20 = 0, the digital keypad controls the set point.
- Pr.08-00 = 1 (negative PID feedback from analog input)

- AVI analog input Pr.03-00 = 5, PID feedback signal.
- Pr.08-01–08-03 is set according to actual conditions.
 - If there is no vibration in the system, increase Pr.08-01 (Proportional Gain (P))
 - If there is no vibration in the system, decrease Pr.08-02 (Integral Time (I))
 - If there is no vibration in the system, increase Pr.08-03 (Differential Time (D))
- Refer to Pr.08-00–08-21 for PID parameter settings.

08-01 Proportional Gain (P)

Default: 1.00

Settings 0.0–500.0 (When Pr.08-23 bit1 = 0)
0.00–500.00 (When Pr.08-23 bit1 = 1)

- 📖 1.0: Kp gain is 100%; if the setting is 0.5, Kp gain is 50%.
- 📖 Eliminates the system error; usually used to decrease the error and get faster response speed. If you set the value too high, it may cause system oscillation and instability.
- 📖 If you set the other two gains (I and D) to zero, proportional control is the only effective parameter.

08-02 Integral Time (I)

Default: 1.00

Settings 0.00–100.00 sec.

- 📖 Use the integral controller to eliminate the error during stable system operation. The integral control does not stop working until the error is zero. The integral is affected by the integral time. The smaller the integral time, the stronger the integral action. It is helpful to reduce overshoot and oscillation for a stable system. Accordingly, the speed to lower the steady-state error decreases. The integral control is often used with the other two controls for the PI controller or PID controller.
- 📖 Sets the integral time of the I controller. When the integral time is long, there is a small I controller gain, with slower response and slow external control. When the integral time is short, there is a large I controller gain, with faster response and rapid external control.
- 📖 When the integral time is too short, it may cause system oscillation.
- 📖 Set Integral Time to 0.00 to disable the parameter Pr.08-02.

08-03 Differential Time (D)

Default: 0.00

Settings 0.00–1.00 sec.

- 📖 Use the differential controller to show the system error change, as well as to preview the change in the error. You can use the differential controller to eliminate the error in order to improve the system state. Using a suitable differential time can reduce overshoot and shorten adjustment time; however, the differential operation increases noise interference. Note that a too large differential causes more noise interference. In addition, the differential shows the change and the differential output is 0 when there is no change. Note that you cannot use the differential control independently. You must use it with the other two controllers to for the PD controller or PID controller.

📖 Sets the D controller gain to determine the error change response. Using a suitable differential time reduces the P and I controllers overshoot to decrease the oscillation for a stable system. A differential time that is too long may cause system oscillation.

📖 The differential controller acts on the change in the error and cannot reduce the interference. Do not use this function when there is significant interference.

↗ **08-04** Upper Limit of Integral Control

Default: 100.0

Settings 0.0–100.0%

📖 Defines an upper bound for the integral gain (I) and therefore limits the master frequency. The formula is:

📖 Integral upper bound = Maximum Operation Frequency (Pr.01-00) x (Pr.08-04%). An excessive integral value causes a slow response due to sudden load changes and may cause motor stall or machine damage.

↗ **08-05** PID Output Command Limit (Positive Limit)

Default: 100.0

Settings 0.0–100.0%

📖 Defines the percentage of the output frequency limit during the PID control. The formula is Output Frequency Limit = Maximum Operation Frequency (Pr.01-00) × Pr.08-05%.

↗ **08-06** PID Feedback Value by Communication Protocol

Default: 0.00

Settings -200.00–200.00%

📖 Use communication to set the PID feedback value when the PID feedback input is set to communication (Pr.08-00 = 7 or 8).

↗ **08-07** PID Delay Time

Default: 0.0

Settings 0.0–2.5 sec.

08-20 PID Mode Selection

Default: 0

Settings 0: Serial connection
1: Parallel connection

📖 0: Use conventional PID control structure.

1: The proportional gain, integral gain and differential gain are independent. You can customize the P, I and D value to fit your application.

📖 Pr.08-07 determines the primary low pass filter time when in PID control. Setting a large time constant may slow down the drive's response rate.

📖 PID control output frequency is filtered with a primary low pass function. This function can filter a mix of frequencies. A long primary low pass time means the filter degree is high and a short primary low pass time means the filter degree is low.

 Inappropriate delay time setting may cause system error.

 PI Control:

Controlled only by the P action, so the deviation cannot be entirely eliminated. In general, to eliminate residual deviations, use the P + I controls. When you use the PI control, it eliminates the deviation caused by the targeted value changes and the constant external interferences. However, if the I action is too powerful, it delays the response when there is rapid variation. You can use the P action by itself to control the loading system with the integral components.

 PD Control:

When deviation occurs, the system immediately generates an operation load that is greater than the load generated only by the D action to restrain the deviation increment. If the deviation is small, the effectiveness of the P action decreases as well. The control objects include applications with integral component loads, which are controlled by the P action only. Sometimes, if the integral component is functioning, the whole system may vibrate. In this case, use the PD control to reduce the P action's vibration and stabilize the system. In other words, this control is useful with no brake function's loading over the processes.

 PID Control:

Use the I action to eliminate the deviation and the D action to reduce vibration; then combine this with the P action for the PID control. Use the PID method for a control process with no deviations, high accuracy, and a stable system.

Serial connection

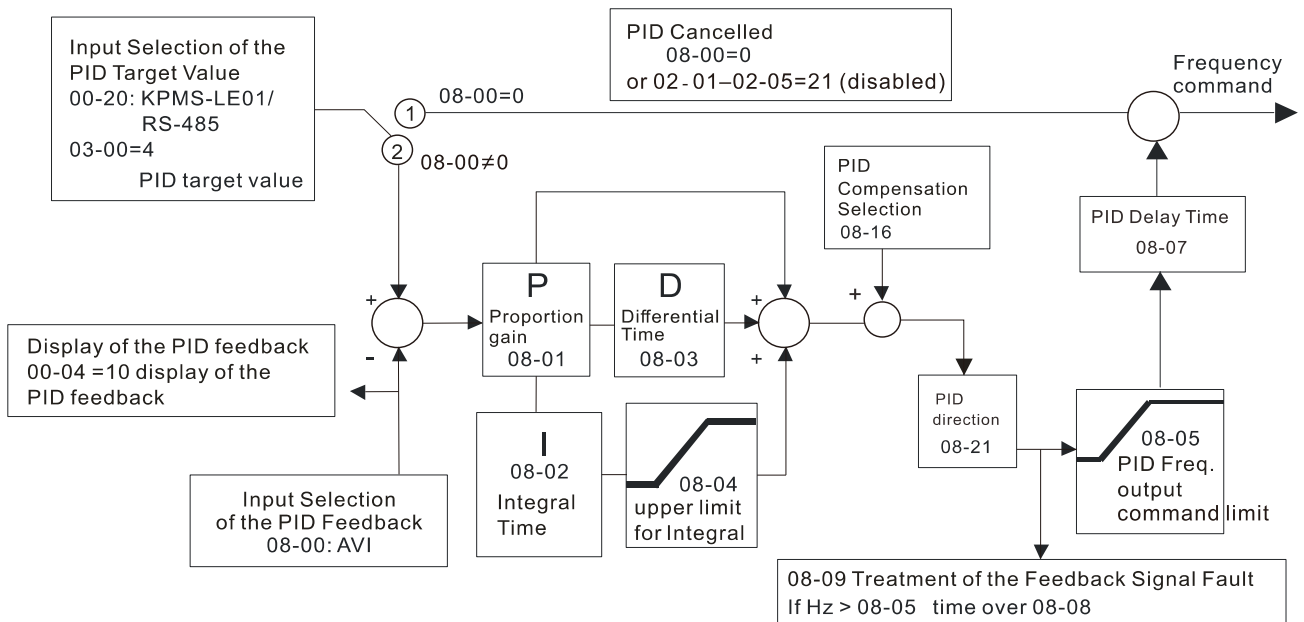

Parallel connection

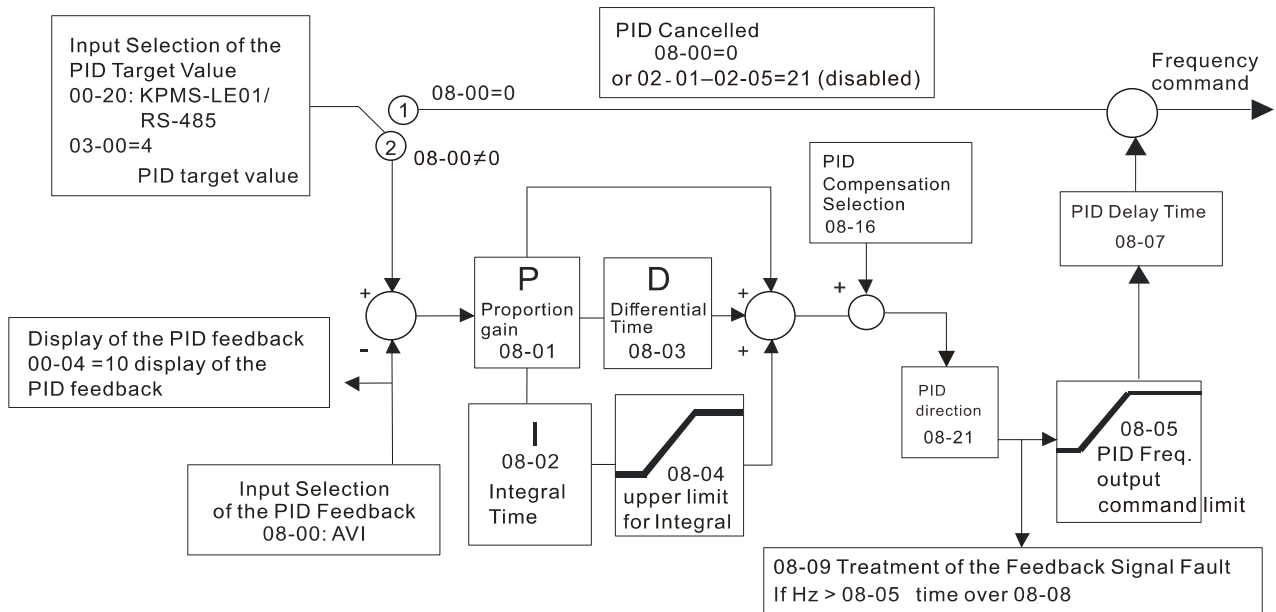

08-08 Feedback Signal Detection Time

Default: 0.0

Settings 0.0–3600.0 sec.

Pr.08-08 is valid only for Pr.03-28=2 (4–20 mA).

This parameter sets the detection time for abnormal PID signal feedback. Setting the detection time to 0.0 disables the detection function.

08-09 Feedback Signal Fault Treatment

Default: 0

Settings 0: Warn and continue operation

1: Warn and ramp to stop

2: Warn and coast to stop

3: Warn and operate at last frequency

This parameter is valid only for Pr.03-28=2 (4–20 mA)..

The AC motor drive acts when the analog PID feedback is abnormal.

08-10 Sleep Frequency













Default: 0.00

Settings 0.00–599.00 Hz

Determines the sleep frequency, and if the sleep time and the wake-up frequency are enabled or disabled.

Pr.08-10 = 0: Disabled

Pr.08-10 = ≠ 0: Enabled

-  **08-11** Wake-up Frequency
 Default: 0.00
-
- Settings 0.00–599.00 Hz
-
-  When Pr.08-18 = 0, the unit for Pr.08-10 and that for Pr.08-11 switch to frequency. The settings are between 0–599.00 Hz.
 -  When Pr.08-18 = 1, the unit for Pr.08-10 and that for Pr.08-11 switch to percentage. The settings then are between 0–200.00%. The percentage is based on the current command value, not the maximum value. For example, if the maximum value is 100 kg, and the current value is 30 kg, then if Pr.08-11 = 40%, the value is 12 kg.
 -  Pr.08-10 uses the same logic for calculation.
-  **08-12** Sleep Time
 Default: 0.0
-
- Settings 0.0–6000.0 sec.
-
-  When the Frequency command is smaller than the sleep frequency and less than the sleep time, the Frequency command is equal to the sleep frequency. However, the Frequency command remains at 0.00 Hz until the Frequency command becomes equal to or larger than the wake-up frequency.
-  **08-13** PID Deviation Level
 Default: 10.0
-
- Settings 1.0–50.0%
-
-  **08-14** PID Deviation Time
 Default: 5.0
-
- Settings 0.1–300.0 sec.
-
-  **08-15** PID Feedback Filter Time
 Default: 5.0
-
- Settings 0.1–300.0 sec.
-
-  When the PID control function is normal, it should calculate the value within a period of time that is close to the target value.
- Refer to the PID control diagram for details. When executing PID feedback control, if $|\text{PID reference target value} - \text{detection value}| > \text{Pr.08-13 PID Deviation Level}$ and exceeds Pr.08-14 setting, it is judged as a PID control fault, and the multi-function output MO = 15 (PID feedback error) activates.
-  **08-16** PID Compensation Selection
 Default: 0
-
- Settings 0: Parameter setting
1: Analog input
-
-  0: The setting for Pr.08-17 gives the PID compensation value.

✎ **08-17** PID Compensation

Default: 0

Settings -100.0–100.0%

📖 The PID compensation value = maximum PID target value × Pr.08-17. For example, if the maximum operation frequency Pr.01-00 = 60 Hz, and Pr.08-17 = 10.0%, the PID compensation value increases the output frequency 6.00 Hz. $60.00 \text{ Hz} \times 100.00\% \times 10.0\% = 6.00 \text{ Hz}$

08-18 Sleep Mode Function Setting

Default: 0

Settings 0: Refer to PID output command
1: Refer to PID feedback signal

📖 0: The unit for Pr.08-10 and that for Pr.08-11 switch to frequency. The settings then are between 0.00–599.00 Hz.
📖 1: The unit for Pr.08-10 and that for Pr.08-11 switch to percentage. The settings then are between 0–200.00%.

✎ **08-19** Wake-up Integral Limit

Default: 50.0

Settings 0.0–200.0%

📖 Reduces the reaction time from sleep to wake-up.
📖 The wake-up integral limit for the drive prevents suddenly running at high speed when the drive wakes up.
The wake-up integral frequency limit = (Pr.01-00 × Pr.08-19%)

08-21 Enable PID to Change the Operation Direction

Default: 0

Settings 0: Operation direction can be changed
1: Operation direction cannot be changed

✎ **08-22** Wake-up Delay Time

Default: 0.00

Settings 0.00–600.00 sec.

📖 Refer to Pr.08-18 for more information.

✎ **08-23** PID Control Flag

Default: 2

Settings bit 0 = 1, PID running in reverse follows the setting for Pr.00-23.
bit 0 = 0, PID running in reverse refers to PID's calculated value.
bit 1 = 1, PID Kp gain is 2 decimal places.
bit 1 = 0, PID Kp gain is 1 decimal place.

📖 bit 0 = 1: Enable PID running in reverse.
📖 bit 0 = 0: If the PID calculated value is positive, the direction is forward. If the PID calculated value is negative, the direction is reverse.

When the setting of bit 1 changes, the Kp gain does not change. For example: Kp = 6, when Pr.08-23 bit 1 = 0, Kp = 6.0; when Pr.08-23 bit 1 = 1, Kp = 6.00.

There are three scenarios for sleep and wake-up frequency.

1) Frequency Command (PID is not in use, Pr.08-00 = 0, only works in VF mode)

When the output frequency \leq the sleep frequency, and the drive reaches the preset sleep time, then drive is in sleep mode. When the Frequency command reaches the wake-up frequency, the drive starts to count the wake-up delay time. When the drive reaches the wake-up delay time, the drive begins acceleration time to reach the Frequency command value.

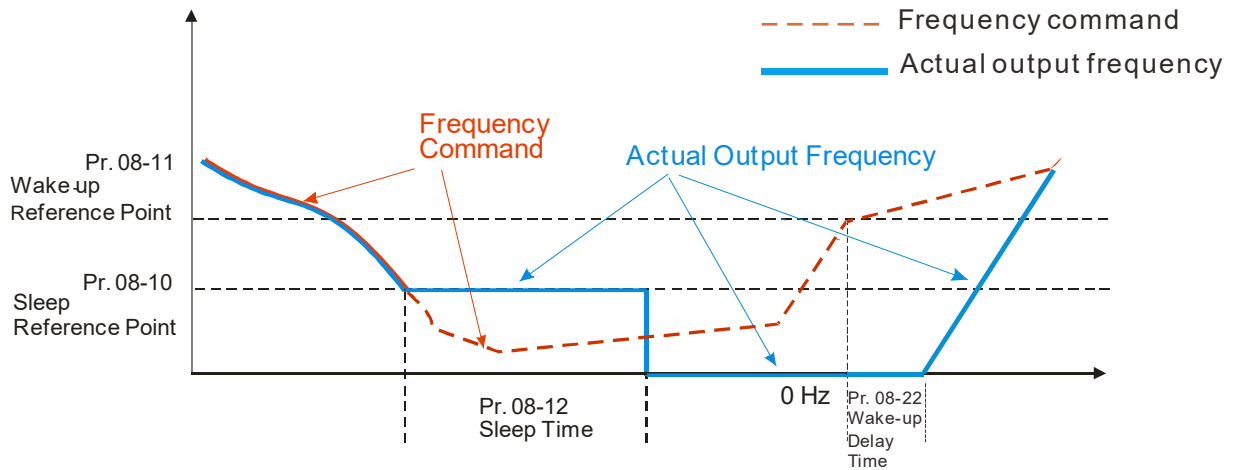

2) Frequency Command Calculation of the Internal PID

When the PID calculation reaches the sleep frequency, the drive starts to count the sleep time and the output frequency starts to decrease. If the drive exceeds the preset sleep time, it goes directly to sleep mode (0 Hz). If the drive does not reach the sleep time, it remains at the lower limit (if there is a preset lower limit.), or it remains at the lowest output frequency set for Pr.01-07 and waits to reach the sleep time before it goes into sleep mode (0 Hz).

When the calculated Frequency command reaches the wake-up frequency, the drive starts to count the wake-up delay time. Once it reaches the wake-up delay time, the drive starts the acceleration time to reach the PID Frequency command value.

Internal PID Calculation Frequency Command

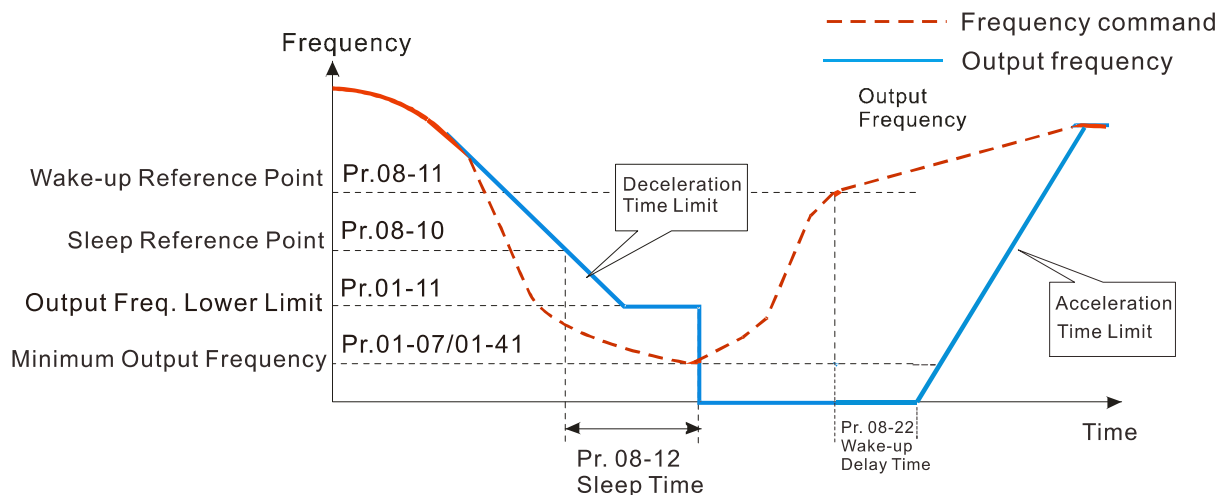

3) PID Feedback Rate Percentage (Use PID, Pr.08-00 ≠ 0 and Pr.08-18 = 1)

When the PID feedback rate reaches the sleep level percentage, the drive starts to count the sleep time. The output frequency also decreases. If the drive exceeds the preset sleep time, it goes to sleep mode (0 Hz). If the drive does not reach the sleep time, it remains at the lower limit (if there is a preset of lower limit.), or it remains at the lowest output frequency set for Pr.01-07 and waits to reach the sleep time before going into sleep mode (0 Hz).

When the PID feedback value reaches the wake-up percentage, the drive starts to count the wake-up delay time. Once it reaches the wake-up delay time, the drive starts the acceleration time to reach the PID Frequency command value.

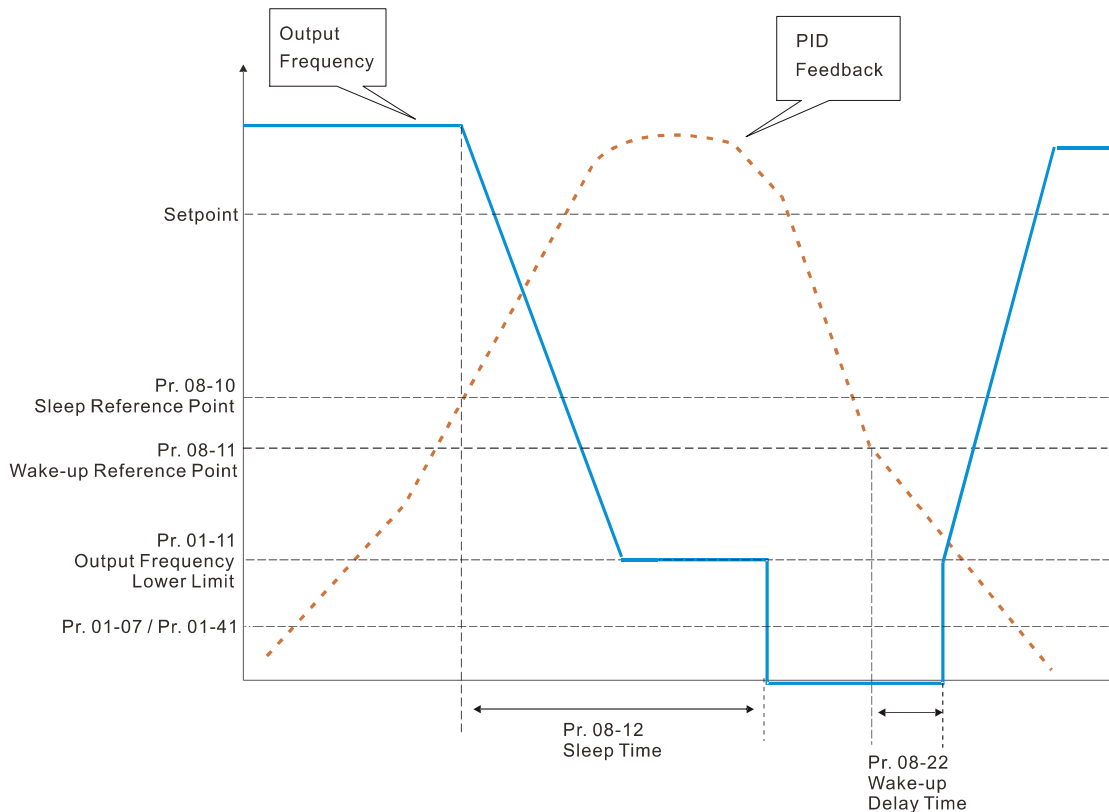

⚡ **08-26** PID Output Command Limit (Reverse Limit)

Default: 100.0

Settings 0.0–100.0%

📖 When PID enables the reverse direction, the PID output amount is a negative value, and the PID output value is limited by the setting for Pr.08-26. Use this function with Pr.08-21.

⚡ **08-27** PID Command Acceleration / Deceleration Time

Default: 0.00

Settings 0.00–655.35 sec.

📖 0.00 seconds: Disables the PID acceleration/deceleration command, and the target value is equal to the PID command.

Not equal to 0.00 seconds: Enables the PID acceleration/deceleration command. For PID acceleration and deceleration, when the PID target value changes, the command value increment/decrement is executed according to this parameter.

09 Communication Parameters

✎ You can set this parameter during operation.

When using communication devices, connect AC drive with PC by using Delta IFD6530 or IFD6500.

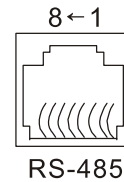

Modbus RS-485
 Pin 1, 2, 6: Reserved
 Pin 3, 7: GND2
 Pin 4: SG-
 Pin 5: SG+
 Pin 8: D+10V

✎ 09-00 Communication Address

Default: 1

Settings 1–254

📖 If RS-485 serial communication controls the AC motor drive, you must set the communication address for this drive in this parameter. Each AC motor drive's communication address must be different.

✎ 09-01 COM1 Transmission Speed

Default: 9.6

Settings 4.8–38.4 Kbps

📖 Sets the transmission speed of the computer and the drive.

📖 Options are 4.8 Kbps, 9.6 Kbps, 19.2 Kbps, or 38.4 Kbps; otherwise, the transmission speed is set to the default 9.6 Kbps.

✎ 09-02 COM1 Transmission Fault Treatment

Default: 3

Settings 0: Warn and continue operation
 1: Display error and ramp to stop
 2: Display error and coast to stop
 3: No warning, no error displayed and continue operation

📖 Sets the response for Modbus communication errors in with the host. Set the detection time in Pr.09-03.

📖 When a transmission error occurs (for example, the error code CE10 is displayed), the error remains even if the transmission status returns to normal, and does not clear automatically. In this case, set a reset command (Reset) to clear the error.

✎ 09-03 COM1 Time-out Detection

Default: 0.0

Settings 0.0–100.0 sec.

📖 Sets the communication time-out.

✎ 09-04 COM1 Communication Protocol

Default: 1

Settings 1: 7N2 (ASCII)
 2: 7E1 (ASCII)
 3: 7O1 (ASCII)
 4: 7E2 (ASCII)

- 5: 7O2 (ASCII)
- 6: 8N1 (ASCII)
- 7: 8N2 (ASCII)
- 8: 8E1 (ASCII)
- 9: 8O1 (ASCII)
- 10: 8E2 (ASCII)
- 11: 8O2 (ASCII)
- 12: 8N1 (RTU)
- 13: 8N2 (RTU)
- 14: 8E1 (RTU)
- 15: 8O1 (RTU)
- 16: 8E2 (RTU)
- 17: 8O2 (RTU)

 Control by PC (Computer Link)

When using the RS-485 serial communication interface, you must specify each drive's communication address in Pr.09-00. The computer then implements control using the drives' individual addresses.

 Modbus ASCII (American Standard Code for Information Interchange): Each byte of data is the combination of two ASCII characters. For example, one byte of data: 64 Hex, shown as '64' in ASCII, consists of '6' (36Hex) and '4' (34Hex).

1. Code Description

The communication protocol is in hexadecimal, ASCII: "0" ... "9", "A" ... "F", every hexadecimal value represents an ASCII code. The following table shows some examples.

Character	'0'	'1'	'2'	'3'	'4'	'5'	'6'	'7'
ASCII code	30H	31H	32H	33H	34H	35H	36H	37H

Character	'8'	'9'	'A'	'B'	'C'	'D'	'E'	'F'
ASCII code	38H	39H	41H	42H	43H	44H	45H	46H

2. Data Format

10-bit character frame (For ASCII):

(7, N, 2)

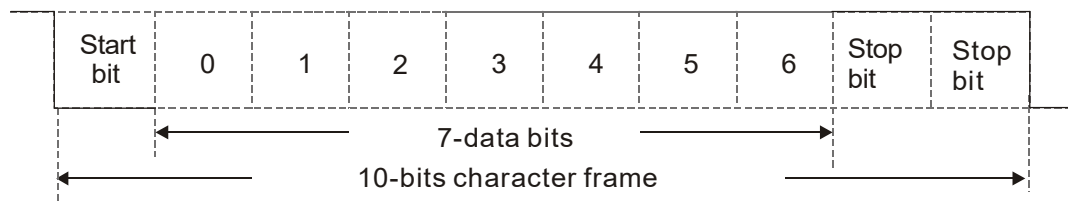

(7, E, 1)

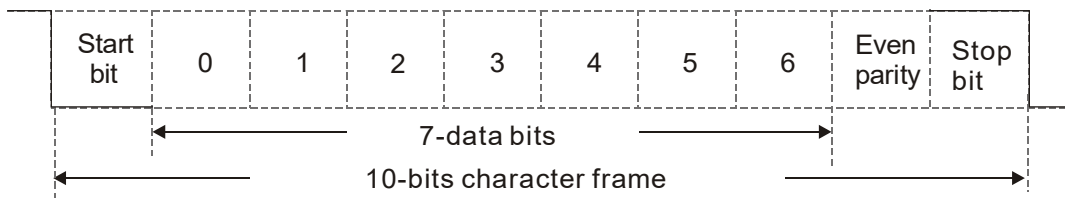

(7, O, 1)

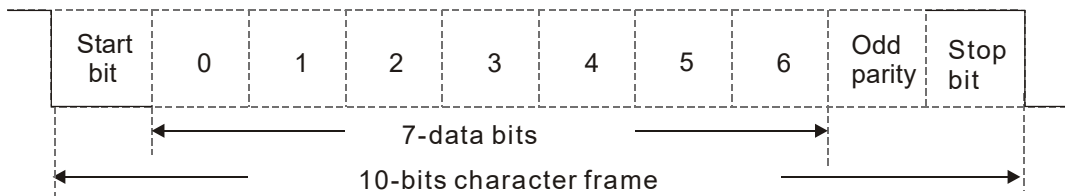

11-bit character frame (For RTU):

(8, N, 2)

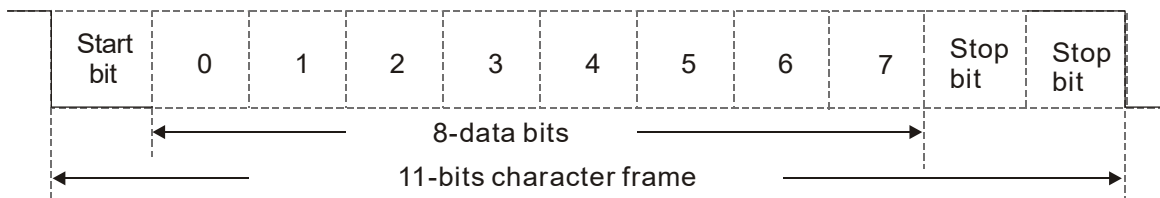

(8, E, 1)

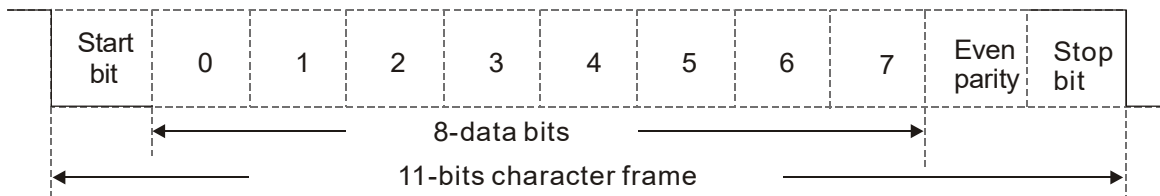

(8, O, 1)

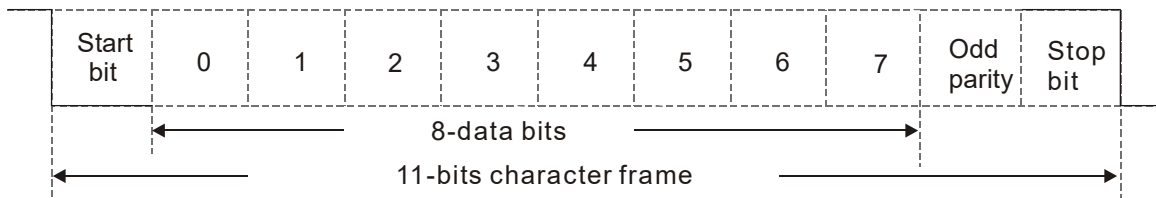

3. Communication Protocol

Communication Data Frame

ASCII mode:

STX	Start character = ':' (3AH)
Address Hi	Communication address: one 8-bit address consists of 2 ASCII codes
Address Lo	
Function Hi	Command code: one 8-bit command consists of 2 ASCII codes
Function Lo	
DATA (n-1)	Contents of data: N x 8-bit data consists of 2n ASCII codes N ≤ 16, maximum of 32 ASCII codes (20 sets of data)
.....	
DATA 0	
LRC CHK Hi	LRC checksum: one 8-bit checksum consists of 2 ASCII codes
LRC CHK Lo	
END Hi	End characters: END Hi = CR (0DH), END Lo = LF (0AH)
END Lo	

RTU mode:

START	Defined by a silent interval of more than 10 ms
Address	Communication address: 8-bit address
Function	Command code: 8-bit command
DATA (n-1)	Contents of data: N x 8-bit data, n ≤ 16
.....	
DATA 0	
CRC CHK Low	CRC checksum: one 16-bit checksum consists of 2 8-bit characters
CRC CHK High	
END	Defined by a silent interval of more than 10 ms

Communication Address (Address)

00H: broadcast to all AC motor drives

01H: AC motor drive of address 01

0FH: AC motor drive of address 15

10H: AC motor drive of address 16

:

FEH: AC motor drive of address 254

Function code (Function) and DATA (Data characters)

03H: read data from a register

06H: write to a single register

Example: Reading two continuous data from register address 2102H. AMD address is 01H.

ASCII mode:

Command Message		Response Message	
STX	‘.’	STX	‘.’
Address	‘0’	Address	‘0’
	‘1’		‘1’
Function	‘0’	Function	‘0’
	‘3’		‘3’
Starting register	‘2’	Number of register (count by byte)	‘0’
	‘1’		‘4’
	‘0’	Content of starting register 2102H	‘1’
	‘2’		‘7’
Number of register (count by word)	‘0’	Content of register 2103H	‘7’
	‘0’		‘0’
	‘0’		‘0’
	‘2’		‘0’
LRC Check	‘D’	LRC Check	‘0’
	‘7’		‘0’
END	CR	END	‘7’
	LF		‘1’
			CR
			LF

RTU mode:

Command Message		Response Message	
Address	01H	Address	01H
Function	03H	Function	03H
Starting data register	21H	Number of register (count by byte)	04H
	02H		Content of register address 2102H
Number of register (count by world)	00H		17H
	02H		70H
CRC CHK Low	6FH	Content of register address 2103H	00H
CRC CHK High	F7H		00H
		CRC CHK Low	FEH
		CRC CHK High	5CH

06H: single write, write single data to a register.

Example: Writing data 6000 (1770H) to register 0100H. AMD address is 01H.

ASCII mode:

Command Message		Response Message	
STX	‘.’	STX	‘.’
Address	‘0’	Address	‘0’
	‘1’		‘1’
Function	‘0’	Function	‘0’
	‘6’		‘6’
Target register	‘0’	Target register	‘0’
	‘1’		‘1’
	‘0’		‘0’
	‘0’		‘0’
Register content	‘1’	Register content	‘1’
	‘7’		‘7’
	‘7’		‘7’
	‘0’		‘0’

LRC Check	'7'	LRC Check	'7'
	'1'		'1'
END	CR	END	CR
	LF		LF

RTU mode:

Command Message		Response Message	
Address	01H	Address	01H
Function	06H	Function	06H
Target register	01H	Target register	01H
	00H		00H
Register content	17H	Register content	17H
	70H		70H
CRC CHK Low	86H	CRC CHK Low	86H
CRC CHK High	22H	CRC CHK High	22H

10H: write multiple registers (write multiple data to registers). The system can write up to 20 sets of data simultaneously.

Example: Set the multi-step speed of an AC motor drive (address is 01H):

Pr.04-00 = 50.00 (1388H), Pr.04-01 = 40.00 (0FA0H)

ASCII Mode:

Command Message		Response Message	
STX	':'	STX	':'
ADR 1	'0'	ADR 1	'0'
ADR 0	'1'	ADR 0	'1'
CMD 1	'1'	CMD 1	'1'
CMD 0	'0'	CMD 0	'0'
Target register	'0'	Target register	'0'
	'5'		'5'
	'0'		'0'
	'0'		'0'
Number of register (count by word)	'0'	Number of register (count by word)	'0'
	'0'		'0'
	'2'		'2'
Number of register (count by Byte)	'0'	LRC Check	'E'
	'4'		'8'
The first data content	'1'	END	CR
	'3'		LF
	'8'		
The second data content	'0'		
	'F'		
	'A'		
LRC Check	'0'		
	'9'		
END	'A'		
	CR		
	LF		

RTU mode:

Command Message		Response Message	
ADR	01H	ADR	01H
CMD	10H	CMD 1	10H
Target register	05H	Target register	05H
	00H		00H
Number of register (count by word)	00H	Number of register (count by word)	00H
	02H		02H
Quantity of data (bytes)	04	CRC Check Low	41H
The first data content	13H	CRC Check High	04H
	88H		
The second data content	0FH		
	A0H		
CRC Check Low	'9'		
CRC Check High	'A'		

Checksum

ASCII mode:

LRC (Longitudinal Redundancy Check) is calculated by summing up the values of the bytes from ADR1 to last data character then calculating the hexadecimal representation of the 2's-complement negation of the sum.

Example:

01H + 03H + 21H + 02H + 00H + 02H = 29H, the 2's-complement negation of 29H is **D7H**.

RTU mode:

CRC (Cyclical Redundancy Check) is calculated by the following steps:

Step 1: Load a 16-bit register (called CRC register) with FFFFH.

Step 2: Exclusive OR the first 8-bit byte of the command message with the low order byte of the 16-bit CRC register, putting the result in the CRC register.

Step 3: Examine the LSB of CRC register.

Step 4: If the LSB of CRC register is 0, shift the CRC register one bit to the right, fill MSB with zero, then repeat step 3. If the LSB of CRC register is 1, shift the CRC register one bit to the right, fill MSB with zero, Exclusive OR the CRC register with the polynomial value A001H, then repeat step 3.

Step 5: Repeat step 3 and 4 until you perform eight shifts. This processes a complete 8-bit byte.

Step 6: Repeat step 2 through 5 for the next 8-bit byte of the command message. Continue doing this until all bytes are processed. The final contents of the CRC register are the CRC value. When transmitting the CRC value in the message, the upper and lower bytes of the CRC value must be swapped, that is, the lower order byte is transmitted first.

The following is an example of CRC generation using C language. The function takes two arguments:

Unsigned char* data ← a pointer to the message buffer

Unsigned char length ← the quantity of bytes in the message buffer

The function returns the CRC value as a type of unsigned integer.

```

Unsigned int crc_chk(unsigned char* data, unsigned char length)
{
    int j;
    unsigned int reg_crc=0Xffff;
    while(length--){
        reg_crc ^= *data++;
        for(j=0;j<8;j++){
            if(reg_crc & 0x01){ /* LSB(b0)=1 */
                reg_crc=(reg_crc>>1) ^ 0Xa001;
            }else{
                reg_crc=reg_crc >>1;
            }
        }
    }
    return reg_crc;          // return register CRC
}

```

4. Address list

Content	Register	Function	
AC motor drive parameters	GGnnH	GG is the parameter group, nn is the parameter number; for example, the address of Pr.04-10 is 040AH.	
Command write only	2000H	bit 1–0	00B: No function
			01B: Stop
			10B: Run
			11B: JOG + RUN
		bit 3–2	Reserved
		bit 5–4	00B: No function
			01B: FWD
			10B: REV
		bit 7–6	00B: 1 st acceleration / deceleration
			01B: 2 nd acceleration / deceleration
			10B: 3 rd acceleration / deceleration
			11B: 4 th acceleration / deceleration
		bit 11–8	000B: Master speed
			0001B: 1 st Step speed frequency
			0010B: 2 nd Step speed frequency
			0011B: 3 rd Step speed frequency
			0100B: 4 th Step speed frequency
0101B: 5 th Step speed frequency			
0110B: 6 th Step speed frequency			
0111B: 7 th Step speed frequency			
1000B: 8 th Step speed frequency			
1001B: 9 th Step speed frequency			
1010B: 10 th Step speed frequency			
1011B: 11 th Step speed frequency			
1100B: 12 th Step speed frequency			
1101B: 13 th Step speed frequency			
1110B: 14 th Step speed frequency			
1111B: 15 th Step speed frequency			
bit 12	1: Enable bit 06–11 function		

Content	Register	Function		
		bit 14–13	00B: No function 01B: Operated by digital keypad 10B: Operated by Pr.00-21 setting 11B: Change operation source	
		bit 15	Reserved	
		2001H	Frequency command (XXX.XX Hz)	
		2002H	bit 0 1: EF (external fault) on bit 1 1: Reset bit 2 1: B.B. ON bit 15–3 Reserved	
	Status monitor read only	2100H	High byte: Warn code Low Byte: Error code	
		2101H	bit 1–0	AC motor drive operation status 00B: Drive stops 01B: Drive decelerating 10B: Drive standby 11B: Drive operating
			bit 2	1: JOG command
			bit 4–3	Operation direction 00B: FWD run 01B: From REV run to FWD run 10B: REV run 11B: From FWD run to REV run
			bit 8	1: Master frequency controlled by communication interface
			bit 9	1: Master frequency controlled by analog signal
bit 10			1: Operation command controlled by communication interface	
bit 11			1: Parameter locked	
bit 12			1: Enable to copy parameters from keypad	
bit 15–13			Reserved	
2102H			Frequency command (XXX.XX Hz)	
2103H		Output frequency (XXX.XX Hz)		
2104H		Output current (XX.XX A). When current is higher than 655.35, it shifts the decimal as (XXX.X A). The decimal can refer to High byte of 211F.		
2105H		DC BUS voltage (XXX.X V)		
2106H		Output voltage (XXX.X V)		
2107H		Current step number of multi-step speed operation		
2108H		Reserved		
2109H		Counter value		
210AH		Power factor angle (XXX.X)		
210BH		Output torque (XXX.X %)		
210CH		Motor speed (XXXXXX rpm)		
210FH		Prompt Power output (X.XXX kW)		
2116H		Multi-function display (Pr.00-04)		
211BH	Maximum Operation Frequency (Pr.01-00) or Maximum User-defined Value (Pr.00-26) When Pr.00-26 is 0, this value is equal to Pr.01-00 setting. When Pr.00-26 is not 0, and the command source is keypad, this value = Pr.00-24 * Pr.00-26 / Pr.01-00. When Pr.00-26 is not 0, and the command source is 485, this value = Pr.09-10 * Pr.00-26 / Pr.01-00.			
211FH	High byte: decimal of current value (display)			
2157H	Display the position of multi-point positioning			

Content	Register	Function
	2200H	Display output current (A). When current is higher than 655.35, it shifts the decimal as (XXX.X A). The decimal can refer to High byte of 211F.
	2201H	Display counter value (c)
	2202H	Actual output frequency (XXXXX Hz)
	2203H	DC BUS voltage (XXX.X V)
	2204H	Output voltage (XXX.X V)
	2205H	Power angle (XXX.X)
	2206H	Display actual motor speed kW of U, V, W (XXXXX kW)
	2207H	Display motor speed in rpm estimated by the drive (XXXXX rpm)
	2208H	Display positive / negative output torque in %, estimated by the drive (+0.0: positive torque, -0.0: negative torque) (XXX.X%)
	2209H	Display PG feedback (see NOTE 1 in Pr.00-04)
	220AH	PID feedback value after enabling PID function (XXX.XX%)
	220BH	Display signal of AVI analog input terminal, 0-10 V corresponds to 0.00–100.00% (2.) (see NOTE 2 in Pr.00-04)
	220CH	Display signal of ACI analog input terminal, 4–20 mA / 0–10 V corresponds to 0.00–100.00% (2.) (as Pr.00-04 see NOTE 2)
	220DH	Reserved
	220EH	IGBT temperature of drive power module (XXX.X °C)
	220FH	Reserved
	2210H	The status of digital input (ON / OFF), refer to Pr.02-12 (see NOTE 3 in Pr.00-04)
	2211H	The status of digital output (ON / OFF), refer to Pr.02-18 (see NOTE 4 in Pr.00-04)
	2212H	The multi-step speed that is executing (S)
	2213H	The corresponding CPU pin status of digital input (d.) (see NOTE 3 in Pr.00-04)
	2214H	The corresponding CPU pin status of digital output (O.) (see NOTE 4 in Pr.00-04)
	2219H	Display times of counter overload (XXX.XX%)
	221AH	GFF (XXX.XX%)
	221BH	DC BUS voltage ripples (XXX.X V)
	221DH	Number of poles of a permanent magnet motor
	221EH	User page displays the value in physical measure
	221FH	Output value of Pr.00-05 (XXX.XX Hz)
	2220H	Number of motor turns when drive operates (saves when drive stops, and resets to zero when operating)
	2221H	Operating position of the motor (saves when drive stops, and resets to zero when operating)
	2222H	Reserved
	2223H	Control mode of the drive. 0: speed mode 1: torque mode
	2224H	Carrier frequency of the drive (XX kHz)
	2225H	Reserved
	2226H	Drive status bit 1–0 00b: No direction 01b: Forward 10b: Reverse bit 3–2 01b: Drive ready 10b: Error bit 4 0b: Motor drive did not output 1b: Motor drive did output bit 5 0b: No alarm 1b: Alarm
	2227H	Drive's estimated output torque (positive or negative direction) (XXXX Nt-m)

Content	Register	Function
	2229H	Accumulate KWH display (XXXX.X)
	222CH	Motor actual position in low word
	222DH	Motor actual position in high word
	222EH	PID reference (XXX.XX%)
	222FH	PID offset (XXX.XX%)
	2230H	PID output frequency (XXX.XX Hz)
	2231H	Reserved
	2232H	Display auxiliary frequency
	2233H	Display master frequency
	2234H	Display frequency after addition and subtraction of auxiliary and master frequencies.

5. Exception response

When the drive is using the communication connection, if an error occurs, the drive responds to the error code and sets the highest bit (bit 7) of code to 1 (function code AND 80H) then responds to the control system to signal that an error occurred.

If the keypad displays “CE-XX” as a warning message, “XX” is the error code at that time. Refer to the table of error codes for communication error for reference.

Example:

ASCII mode		RTU mode:	
STX	‘.’	Address	01H
Address	‘0’	Function	86H
	‘1’	Exception code	02H
Function	‘8’	CRC CHK Low	C3H
	‘6’	CRC CHK High	A1H
Exception code	‘0’		
	‘2’		
LRC CHK	‘7’		
	‘7’		
END	CR		
	LF		

The explanation of error codes

Error code	Explanation
1	Function code is not supported or unrecognized.
2	Address is not supported or unrecognized.
3	Data is not correct or unrecognized.
4	Failure to execute this function code

09-09 Communication Response Delay Time

Default: 2.0

Settings 0.0–200.0 ms

📖 Sets the response delay time after the AC motor drive receives a communication command as shown in the following.

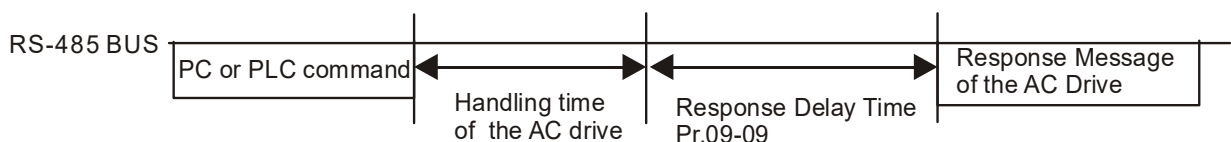

09-10 Communication Main Frequency

Default: 60.00

Settings 0.00–599.00 Hz

📖 When you set Pr.00-20 to 1 (RS-485 serial communication), the AC motor drive saves the last Frequency command into Pr.09-10 when there is abnormal power off or momentary power loss. After the drive reboots when power is restored, it checks the frequency in Pr.09-10 if no new Frequency command is input. When a Frequency command of 485 changes (the Frequency command source must be set as Modbus), this parameter also changes.

- ↗ **09-11** Block Transfer 1
- ↗ **09-12** Block Transfer 2
- ↗ **09-13** Block Transfer 3
- ↗ **09-14** Block Transfer 4
- ↗ **09-15** Block Transfer 5
- ↗ **09-16** Block Transfer 6
- ↗ **09-17** Block Transfer 7
- ↗ **09-18** Block Transfer 8
- ↗ **09-19** Block Transfer 9
- ↗ **09-20** Block Transfer 10
- ↗ **09-21** Block Transfer 11
- ↗ **09-22** Block Transfer 12
- ↗ **09-23** Block Transfer 13
- ↗ **09-24** Block Transfer 14
- ↗ **09-25** Block Transfer 15
- ↗ **09-26** Block Transfer 16

Default: 0

Settings 0–65535

📖 There is a group of block transfer parameters available in the AC motor drive (Pr.09-11–Pr.09-26). Using communication code 03H, you can store the parameters (Pr.09-11–Pr.09-26) that you want to read.

09-30 Communication Decoding Method

Default: 1

Settings 0: Decoding method 1
1: Decoding method 2

		Decoding Method 1	Decoding Method 2
Source of Operation Control	Digital Keypad	Digital keypad controls the drive action regardless of decoding method 1 or 2.	
	External Terminal	External terminal controls the drive action regardless of decoding method 1 or 2.	
	RS-485	Refer to address: 2000h–20FFh	Refer to address: 6000h–60FFh

10 Speed Feedback Control Parameters

✎ You can set this parameter during operation.

In this parameter group, ASR stands for Adjust Speed Regulator and PG stands for Pulse Generator.

✎ 10-16 Pulse Input Type Setting

Default: 0

Settings 0: Disabled
5: Single-phase pulse input
6: PWM signal input

- 📖 When Pr.00-20 = 4, the command source is MI5. Then, you can select external command as PWM mode through Pr.10-16.
- 📖 When you set Pr.10-16 = 0, the function for this parameter is disabled. When you set Pr.10-16 = 5, the pulse input type is single-phase pulse mode with a steady maximum input pulse frequency of 10 kHz and a corresponding relationship between 0–10 kHz pulse signal and 0–Fmax (Pr.01-00) frequency command. For example, if 10/2 = 5 kHz pulse signal corresponds to Fmax/2 frequency command, and when the input pulse exceeds 10 kHz, the frequency command remains at Fmax (Pr.01-00).
- 📖 When you set Pr.10-16 = 0, the function for this parameter is disabled. When you set Pr.10-16 = 6, pulse input type is PWM mode. You can set how long the PWM outputs a command after how many times of averaging and set the period of external PWM both through Pr.07-43. The average value for frequency command and output speed depends on the settings for these two parameters. Refer to Pr.07-43 for detailed descriptions.

✎ 10-29 Top Limit of Frequency Deviation

Default: 20.00

Settings 0.00–100.00 Hz

- 📖 Limits the maximum frequency deviation.
- 📖 If you set this parameter too high, an abnormal feedback malfunction occurs.

✎ 10-31 I/F Mode, Current Command

Default: 40

Settings 0–150% rated current of the motor

- 📖 Sets the current command for the drive in the low speed area. When the motor stalls on heavy duty start-up or forward/reverse with load, increase the parameter value. If the inrush current is too high and causes oc stall, then decrease the parameter value.

✎ 10-32 PM FOC Sensorless Speed Estimator Bandwidth

Default: 5.00

Settings 0.00–600.0 z

- 📖 Sets the speed estimator bandwidth. Adjust the parameter to change the stability and the accuracy of the motor speed. If there is low frequency vibration (the waveform is similar to sine wave) during the process, then increase the bandwidth. If there is high frequency vibration (the waveform shows extreme vibration and is like a spur), then decrease the bandwidth.

10-34 PM Sensorless Speed Estimator Low-pass Filter Gain

Default: 1.00

Settings 0.00–655.35

- 📖 Changes the response speed of the speed estimator.
- 📖 If there is low frequency vibration (the waveform is similar to a sine wave) during the process, then increase the gain. If there is high frequency vibration (the waveform shows extreme vibration and is like a spur), then decrease the gain.

10-42 Initial Angle Detection Pulse Value

Default: 1.0

Settings 0.0–3.0

- 📖 The angle detection is fixed to 3: Use the pulse injection method to start.
The parameter influences the value of the pulse during the angle detection. The larger the pulse, the higher the accuracy of rotor's position. A larger pulse might cause oc.
- 📖 Increase the parameter when the running direction and the command are opposite during start-up. If oc occurs at start-up, then decrease the parameter.
- 📖 Refer to Section 12-2 Adjustment & Application for detailed motor adjustment procedure.

10-49 Zero Voltage Time During Start-up

Default: 00.000

Settings 00.000–60.000 sec.

- 📖 This parameter is valid only when the setting of Pr.07-12 (Speed Tracking during Start-up) = 0.
- 📖 When the motor is in static state at start-up, this increases the accuracy when estimating angles. In order to put the motor in static state, set the three-phase drive output to 0 V to the motor. The Pr.10-49 setting time is the length of time for three-phase output at 0 V.
- 📖 It is possible that even when you apply this parameter, the motor cannot go in to the static state because of inertia or some external force. If the motor does not go into the static state in 0.2 seconds, increase this setting value appropriately.
- 📖 If Pr.10-49 is too high, the start-up time is longer. If it is too low, then the braking performance is weak.

10-51 Injection Frequency

Default: 500





Settings 0–1200 Hz

- 📖 This parameter is a high frequency injection command in PM SVC control mode, and usually you do not need to adjust it. But if a motor's rated frequency (for example, 400 Hz) is too close to the frequency setting for this parameter (that is, the Default of 500 Hz), it affects the accuracy of the angle detection. Refer to the setting for Pr.01-01 before you adjust this parameter.
- 📖 If the setting value for Pr.00-17 is lower than Pr.10-51*10, then increase the frequency of the carrier wave.
- 📖 Pr.10-51 is valid only when Pr.10-53 = 2.

↗ 10-52 Injection Magnitude

Default: 15.0 / 30.0

Settings 0.0–200.0 V

-  The parameter is the magnitude command for the high frequency injection signal in PM SVC control mode.
-  Increasing the parameter can increase the accuracy of the angle estimation, but the electromagnetic noise might be louder if the setting value is too high.
-  The system uses this parameter when the motor's parameter is "Auto". This parameter influences the angle estimation accuracy.
-  When the ratio of the salient pole (L_q/L_d) is lower, increase Pr.10-52 to make the angle detection more accurate.
-  Pr.10-52 is valid only when Pr.10-53 = 2.

↗ 10-53 Position Detection Method

Default: 0

Settings 0: Disabled

1: Internal 1/4 rated current attracting the rotor to zero degrees

2: High frequency injection

 3: Pulse injection

-  Set to 2 for IPM; set to 3 for SPM. If these settings cause problems, then set the parameter to 1.

[This page intentionally left blank]

11 Advanced Parameters

⚡ You can set this parameter during operation.

In this parameter group, ASR stands for Adjust Speed Regulator.

11-00 System Control	Default: 0
bit 3: Dead time compensation closed bit 7: Save or do not save the frequency	

11-41 PWM Mode Selection	Default: 2
Settings 0: Two-phase 2: Space vector	

📖 Two-phase mode: effectively reduces the drive power components losses and provides better performance in long wire applications.

📖 Space vector mode: effectively reduces the power loss and electromagnetic noise of the motor.

⚡ 11-42 PWM Mode Selection	Default: 0000
Settings 0000–FFFFh	

bit No.	Function	Description
0	Reserved	
1	FWD / REV action control	0: FWD / REV cannot be controlled by Pr.02-12 bit 0 & 1. 1: FWD / REV can be controlled by Pr.02-12 bit 0 & 1.
2–15	Reserved	

[This page intentionally left blank]

12 Function Parameters

✎ You can set this parameter during operation.

In this parameter group, ASR stands for Adjust Speed Regulator.

✎	12-20	Simple Positioning Stop Frequency 0	Default: 0.00
	Settings	0.00–599.00 Hz	
✎	12-21	Simple Positioning Stop Frequency 1	Default: 5.00
	Settings	0.00–599.00 Hz	
✎	12-22	Simple Positioning Stop Frequency 2	Default: 10.00
	Settings	0.00–599.00 Hz	
✎	12-23	Simple Positioning Stop Frequency 3	Default: 20.00
	Settings	0.00–599.00 Hz	
✎	12-24	Simple Positioning Stop Frequency 4	Default: 30.00
	Settings	0.00–599.00 Hz	
✎	12-25	Simple Positioning Stop Frequency 5	Default: 40.00
	Settings	0.00–599.00 Hz	
✎	12-26	Simple Positioning Stop Frequency 6	Default: 50.00
	Settings	0.00–599.00 Hz	
✎	12-27	Simple Positioning Stop Frequency 7	Default: 60.00
	Settings	0.00–599.00 Hz	

📖 The settings for Pr.12-20–Pr.12-27 must meet the following condition:

$Pr.12-20 \leq Pr.12-21 \leq Pr.12-22 \leq Pr.12-23 \leq Pr.12-24 \leq Pr.12-25 \leq Pr.12-26 \leq Pr.12-27$.

📖 If any two of the parameters (between Pr.012-20–Pr.12-27) have the same stop frequency, their Delay Time of Simple Positioning Stop must be the same as well.

✎	12-28	Delay Time of Simple Positioning Stop 0
✎	12-29	Delay Time of Simple Positioning Stop 1
✎	12-30	Delay Time of Simple Positioning Stop 2
✎	12-31	Delay Time of Simple Positioning Stop 3
✎	12-32	Delay Time of Simple Positioning Stop 4

↗	12-33	Delay Time of Simple Positioning Stop 5
↗	12-34	Delay Time of Simple Positioning Stop 6
↗	12-35	Delay Time of Simple Positioning Stop 7

Default: 0.00

Settings 0.00–600.00 sec.

- Valid only when Pr.00-22 is set to 2: motor stops by simple positioning.
- The settings for Pr.12-20–Pr.12-27 must correspond to the settings for Pr.12-28–Pr.12-35.

Corresponding parameters :

(Pr.12-20, Pr.12-28)	(Pr.12-21, Pr.12-29)	(Pr.12-22, Pr.12-30)	(Pr.12-23, Pr.12-31)
(Pr.12-24, Pr.12-32)	(Pr.12-25, Pr.12-33)	(Pr.12-26, Pr.12-34)	(Pr.12-27, Pr.12-35)

- The function of Pr.12-28–Pr.12-35 is simple positioning. Speed starts to decelerate after the time set at Pr.12-28–Pr.12-35 elapse. The accuracy of positioning is self-assessed by user.

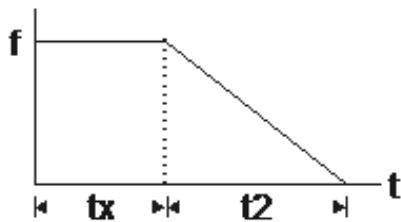

$$S = n \times \left(\frac{t_x + (t_x + t_2)}{2} \right) \quad n = f \times \frac{120}{p}$$

$$S = n \times \left(\frac{t_x + (t_x + t_2)}{2} \right)$$

$$n = f \times \frac{120}{p}$$

s: distance travelled (revolution)

n: rotation speed (revolution/ minute)

n: rotation speed (revolution/second)

p: number of poles of motors

t_x : delay time (second)

f: rotation frequency (Hz)

t_2 : deceleration time (second)

The value of t_x in the equation above is as shown below:

1.1 When the slope is negative ($t_1 > t_2$)

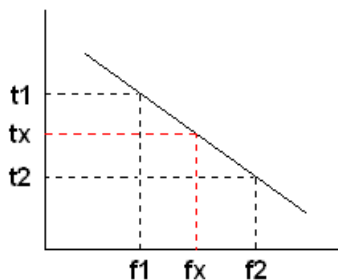

$$t_x = t_1 + \left(\frac{f_x - f_1}{f_2 - f_1} \right) \times (t_2 - t_1) = t_1 + \left(\frac{f_x - f_1}{10} \right) \times (t_2 - t_1)$$

1.2 When the slope is positive ($t_1 < t_2$)

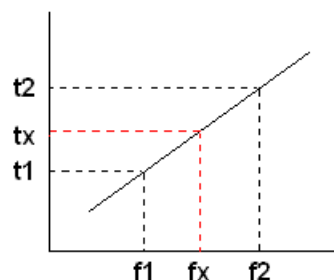

$$t_x = t_2 - \left(\frac{f_2 - f_x}{f_2 - f_1} \right) \times (t_2 - t_1) = t_2 - \left(\frac{f_2 - f_x}{10} \right) \times (t_2 - t_1)$$

As shown in the image below, a four-pole motor turntable's diameter = r and its rotation speed = n (RPM).

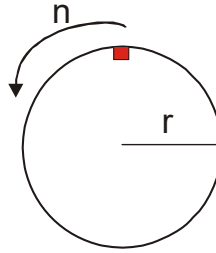

Example 01:

When the motor turntable is rotating at 50 Hz, Pr.00-22 = 2 (motor stops by simple positioning), Pr.12-26 = 50 Hz (Simple Positioning Stop Frequency 6), and its corresponding Pr.12-34 = 2 seconds (Delay Time of Simple Positioning Stop 6), the deceleration time is 10 seconds for decreasing from 50 Hz to 0 Hz.

When STOP command is given, Simple Positioning Stop is activated, its rotation speed is $n = 120 \times 50 / 4$ (revolution / minute) = 25 (revolution / second).

Number of revolutions of motor turntable = $(25 \times (2 + 12)) / 2 = 175$ (revolutions)

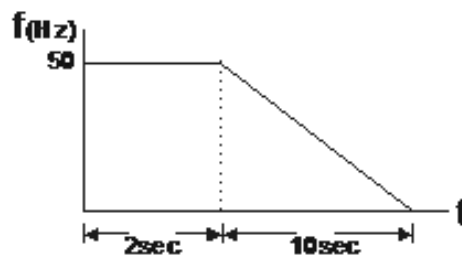

Therefore, the distance travelled by the motor after the STOP command is given = number of revolutions \times circumference = $175 \times 2 \pi r$. It means the turntable returns to the top after 175 revolutions.

Example 02:

If the turntable rotates at 1.5 Hz, Pr.12-22 = 10 Hz (Simple Positioning Stop Frequency 2), Pr.12-21 = 0 Hz, and Pr.12-30 = 10 seconds (Delay Time of Simple Positioning Stop 2), then the deceleration time is 40 seconds for decreasing from 60 Hz to 0 Hz.

The delay time to stop of 1.5 Hz is 1.5 seconds, the deceleration time is 1 second for decreasing from 1.5 Hz to 0 Hz.

When STOP command is given, Simple Positioning Stop is activated, its rotation speed is $n = 120 \times 1.5 / 4$ (revolution / minute) = 1.5 / 2 (revolution / second).

Number of revolutions of motor turntable = $(1.5/2 \times (1.5 + 2.5)) / 2 = 1.5$ (revolutions)

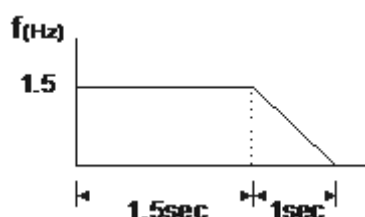

Therefore, the distance travelled by the motor after the STOP command is given = number of revolutions \times circumference = $1.5 \times 2 \pi r$. It means the turntable stopped after 1.5 revolutions.

12-40 Automatic Operation Mode

Default: 0

- Settings
- 0: Disable operation
 - 1: Execute one program cycle
 - 2: Continuously execute program cycles
 - 3: Execute one program cycle step by step
 - 4: Continuously execute one program cycle step by step
 - 5: Disable automatic operation, but the direction setting at multi-step speed 1 to 7 are effective

This parameter selects the mode of PLC operation for the AC motor drive. The PLC program can be applied for any external controls, relays or switches. The AC motor drive changes speeds and directions according to your desired programming.

When this parameter is set to 5 and it is running by external multi-speed, the highest priority of the operation direction is Pr.12-41.

Example 1 (Pr.12-40 = 1)

Execute one cycle of the PLC program. Related parameter settings are:

- Pr.04-00–04-06: 1st to 7th step speed (sets the frequency of each step speed).
- Pr.02-01–02-05: Multi-Function Input Terminals (set one multi-function terminal as 94-Programmable AUTO RUN).
- Pr.02-13–02-16: Multi-Function Output Terminals (set a Multi-Function Terminal as 77-program running indication, 78-Program Step Completed Indication or 79-Program Running Completed Indication).
- Pr.12-40: PLC mode.
- Pr.12-41: Direction of operation for Master Frequency and 1st to 7th step speed.
- Pr.12-42–12-49: Operation time setting of Master Frequency and 1st to 7th step speed.

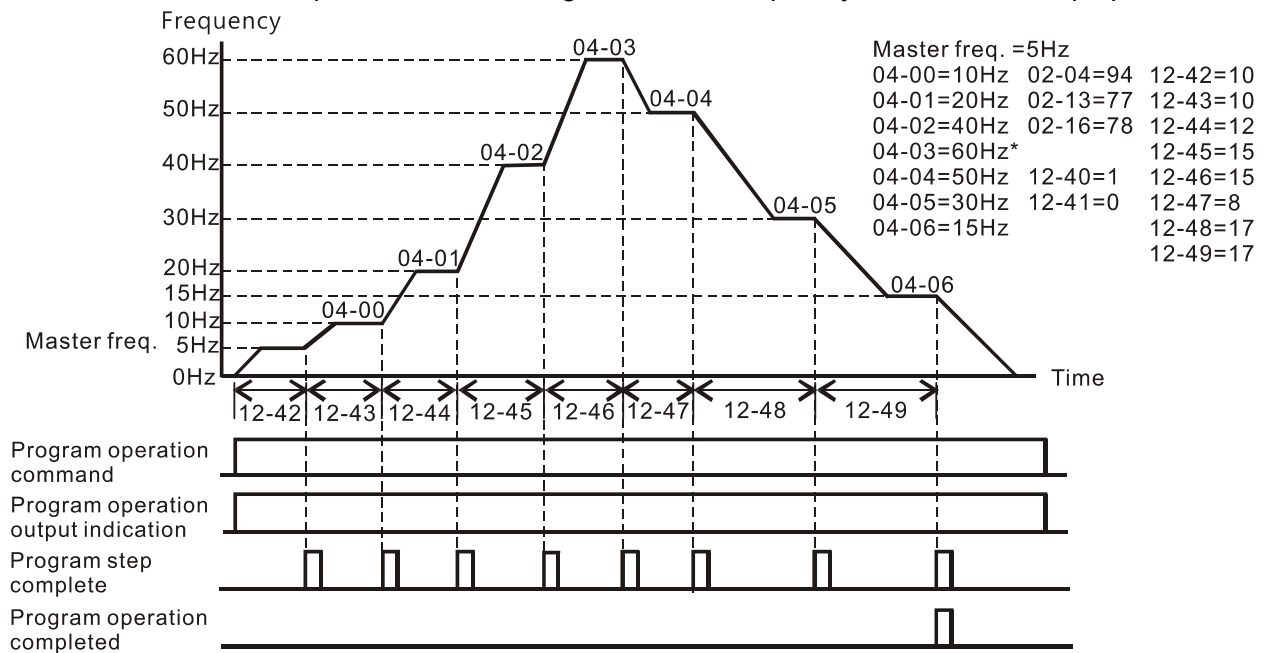

The diagram above shows one complete PLC cycle. To restart the cycle, turn the PLC program off and then turn back on.

Example 2 (Pr.12-40 = 2)

Continuously executes program cycles

The diagram below shows the PLC program stepping through each speed and then automatically starting again. To stop the PLC program, you must either pause the program or turn it off.

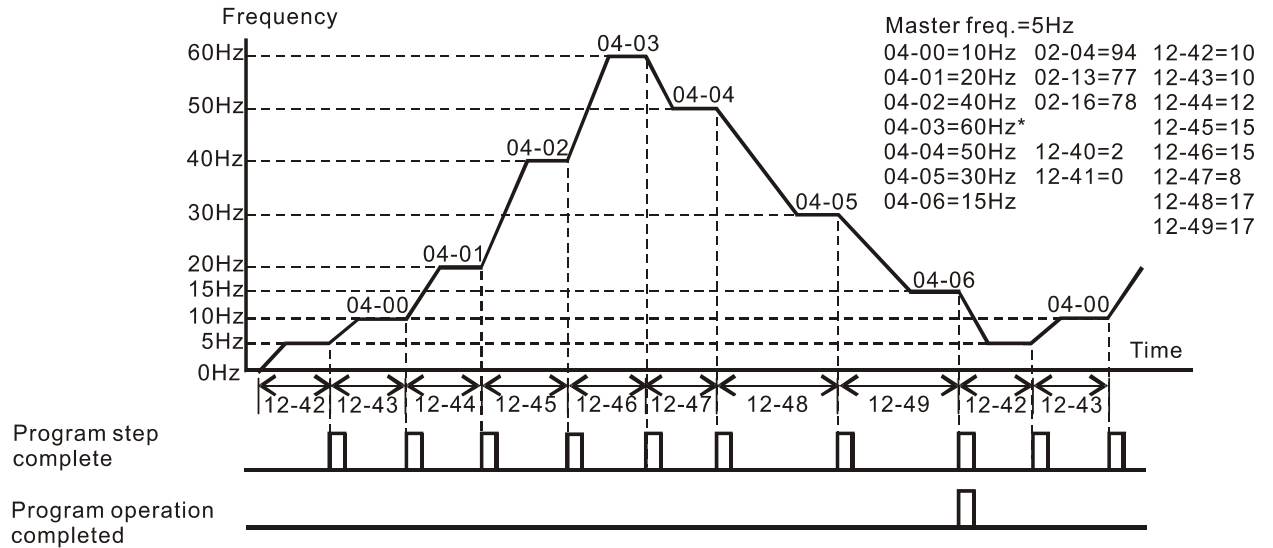

Example 3 (Pr.12-40 = 3)

Execute one program cycle step by step

The example shows how the PLC executes one program cycle at a time within a complete cycle. Each step uses the acceleration/deceleration time.

Noted that the time each step spends at its desired frequency reduces due to the time spent during acceleration/deceleration.

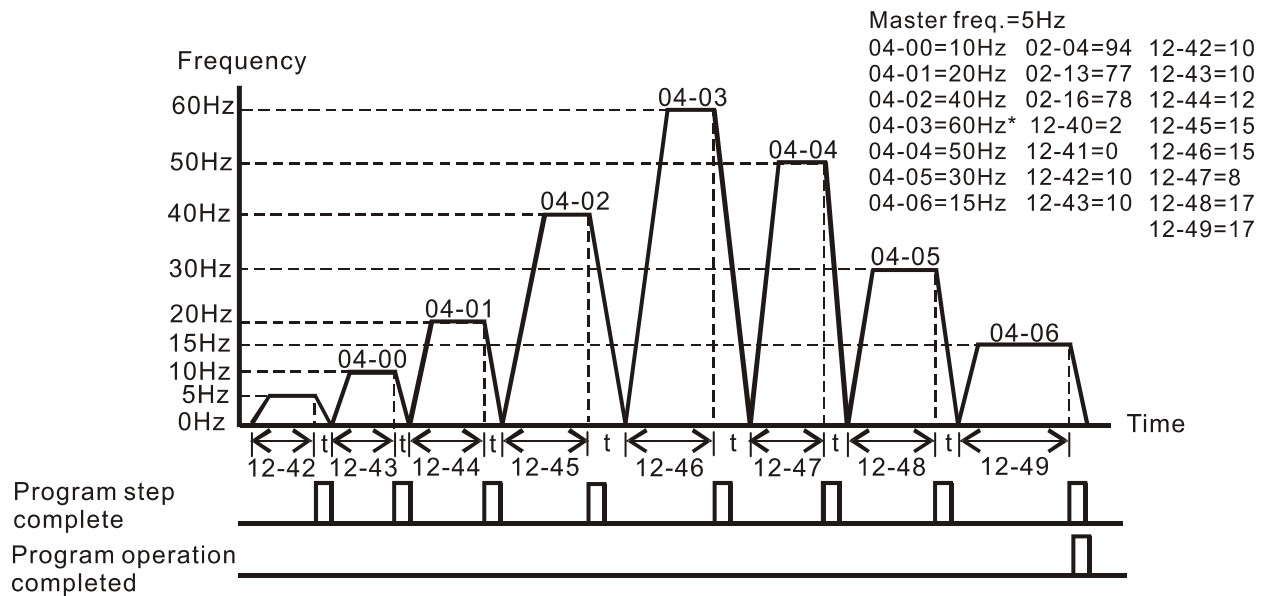

Example 4 (Pr.12-40 = 4)

Continuously execute PLC cycles step by step

In this example, PLC program runs continuously step by step. The diagram shown below is the example of steps in reverse direction.

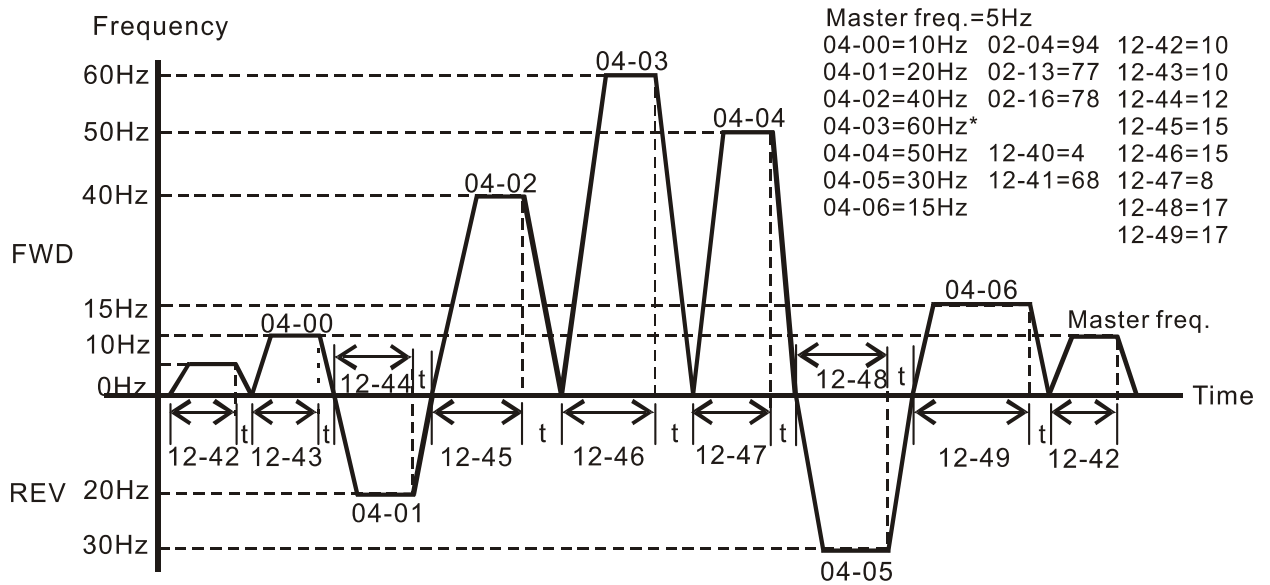

Example 5 (Pr.12-40=1)

Execute one cycle of the PLC program

In this example, the PLC program runs continuously. Noted that the times of reserve motion may be shorter than expected due to the acceleration/deceleration time.

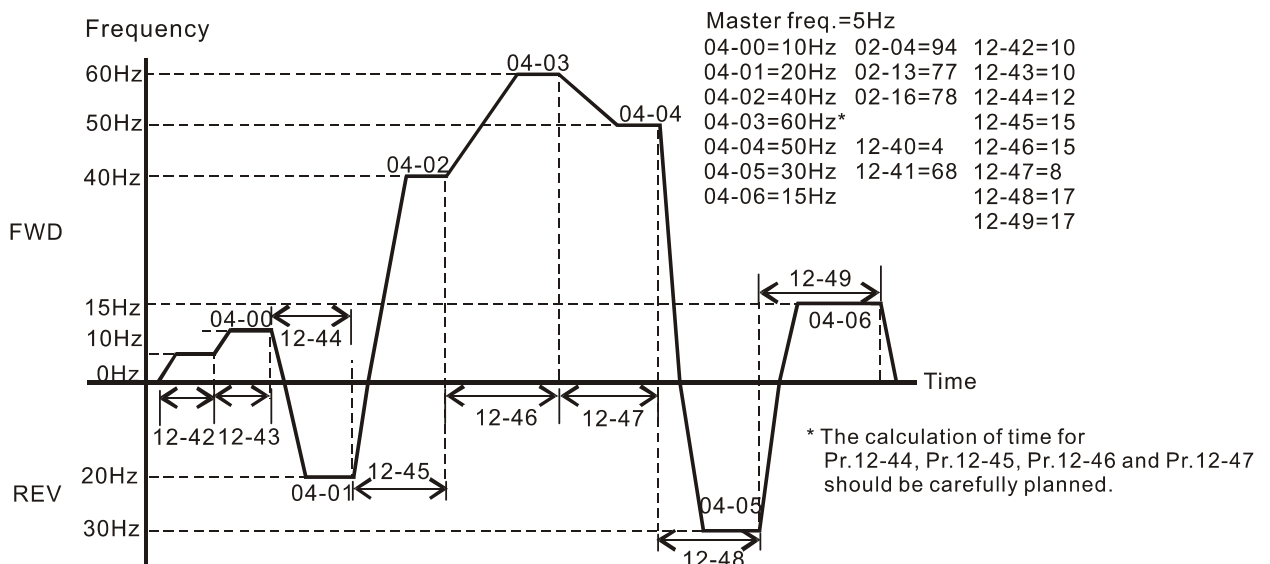

* The calculation of time for Pr.12-44, Pr.12-45, Pr.12-46 and Pr.12-47 should be carefully planned.

12-41 PLC Program Running Direction Mode

Default: 0

- Settings bit 0–bit 7 (0: FWD RUN, 1: REV RUN)
- bit 0: Direction of auto-operation's main speed
 - bit 1: Direction of 1st speed for Pr.04-00
 - bit 2: Direction of 2nd speed for Pr.04-01
 - bit 3: Direction of 2nd speed for Pr.04-02
 - bit 4: Direction of 2nd speed for Pr.04-03
 - bit 5: Direction of 2nd speed for Pr.04-04
 - bit 6: Direction of 2nd speed for Pr.04-05
 - bit 7: Direction of 2nd speed for Pr.04-06

- 📖 This parameter controls the direction of motion for the Multi-Step Speed Pr.04-00 to Pr.04-06 and the Master Frequency. The original direction of Master Frequency will become invalid.
- 📖 The equivalent 8-bit number is used to program the forward/reverse motion for each of the 8 speed steps (including Master Frequency). The binary 8-bit number must convert to decimal, and then you can enter this parameter.

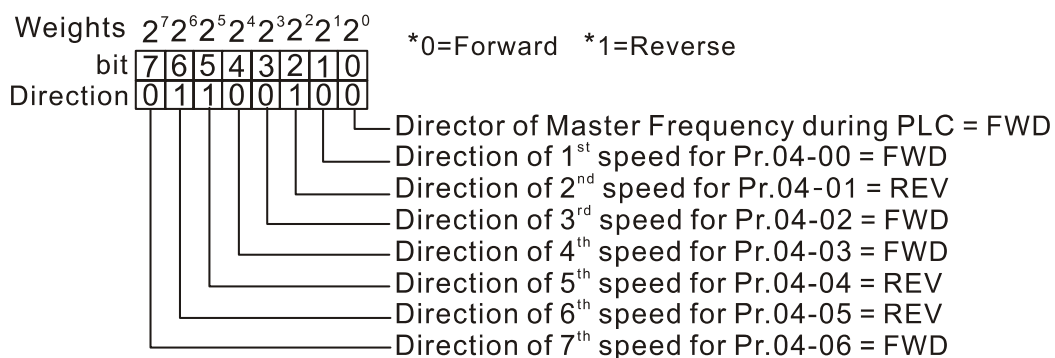
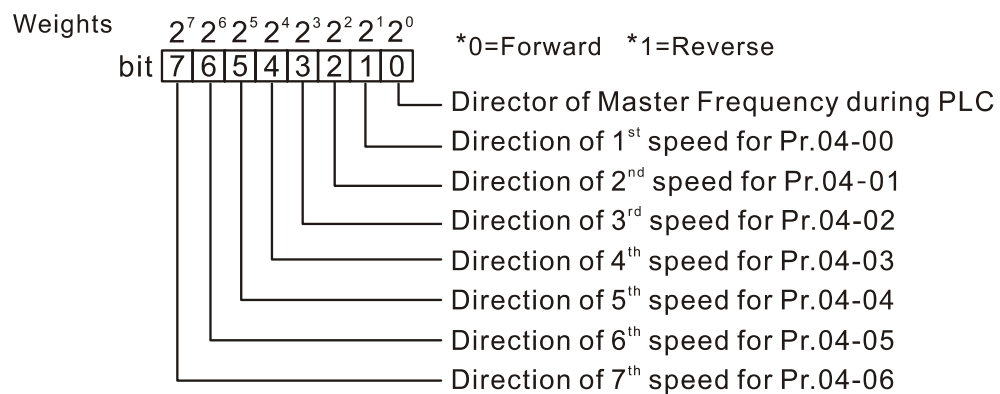

The setting value

$$= \text{bit}7 \times 2^7 + \text{bit}6 \times 2^6 + \text{bit}5 \times 2^5 + \text{bit}4 \times 2^4 + \text{bit}3 \times 2^3 + \text{bit}2 \times 2^2 + \text{bit}1 \times 2^1 + \text{bit}0 \times 2^0$$

$$= 0 \times 2^7 + 1 \times 2^6 + 1 \times 2^5 + 0 \times 2^4 + 0 \times 2^3 + 1 \times 2^2 + 0 \times 2^1 + 0 \times 2^0$$

$$= 0 + 64 + 32 + 16 + 0 + 0 + 2 + 0$$



$$= 100 \quad \text{Setting Pr.12-41} = 100$$

$2^0=1$	$2^3=8$	$2^6=64$
$2^1=2$	$2^4=16$	$2^7=128$
$2^2=4$	$2^5=32$	

12-42	Main Frequency Time Setting
12-43	1 st Speed Time Setting
12-44	2 nd Speed Time Setting
12-45	3 rd Speed Time Setting
12-46	4 th Speed Time Setting
12-47	5 th Speed Time Setting
12-48	6 th Speed Time Setting
12-49	7 th Speed Time Setting

Default: 0

Settings 0–65500 sec.

-  Pr.12-42 to Pr.12-49 correspond to the operation time for each multi-step speed defined. The maximum value for these parameters is 65500 sec., and it displays as 65.5.
-  If it is set to 0 (0 sec.), the corresponding step skips. This is commonly used to reduce number of program steps.

13 Macro / User-Defined Macro

13-00 Application Selection

Default: 00

- Settings
- 00: Disabled
 - 01: User-Defined parameter
 - 03: Fan
 - 04: Pump
 - 05: Conveyor
 - 07: Packing

 Note: after you select the macro, some of the default values adjust automatically according to the application selection.

 Group setting 03: Fan

The following table lists the relevant fan setting application parameters.

Pr.	Explanation	Settings
00-11	Speed control mode	0 (VF)
00-16	Load selection	0 (Normal load)
00-17	Carrier frequency	Default setting
00-20	Master frequency command source (AUTO)	2 (External analog input)
00-21	Operation command source (AUTO)	1 (External terminals)
00-22	Stop method	1 (Coast to stop)
00-23	Control of motor direction	1 (Disable reverse)
00-30	Master frequency command source (HAND)	0 (Digital keypad)
00-31	Operation command source (HAND)	0 (Digital keypad)
01-00	Motor 1 maximum operation frequency	Default setting
01-01	Motor 1 output frequency	Default setting
01-02	Motor 1 output voltage	Default setting
01-03	Motor 1 mid-point frequency 1	Default setting
01-04	Motor 1 mid-point voltage 1	Default setting
01-05	Motor 1 mid-point frequency 2	Default setting
01-06	Motor 1 mid-point voltage 2	Default setting
01-07	Motor 1 minimum output frequency	Default setting
01-08	Motor 1 minimum output voltage	Default setting
01-10	Output frequency upper limit	50 (Hz)
01-11	Output frequency lower limit	35 (Hz)
01-12	Acceleration time 1	15 (s)
01-13	Deceleration time 1	15 (s)
01-43	V/F curve selection	2 (Second V/F curve)
02-05	Multi-function input command 5 (MI5)	15: Rotating speed command from AVI
02-16	Multi-function output 2 (MO1)	11 (Malfunction indication)

03-00	Analog input selection (AVI)	1 (Frequency command)
03-28	AVI terminal input selection	0 (0–10 V)
03-50	Analog input curve selection	1 (three-point curve of AVI)
07-06	Restart after momentary power loss	2 (Speed tracking by minimum output frequency)
07-11	Number of times of auto-restart after fault	5 (times)
07-33	Auto-restart interval of fault	60 (s)

 Group setting 04: Pump

The following table lists the relevant pump setting application parameters.

Pr.	Explanation	Settings
00-11	Speed control mode	0 (VF)
00-16	Load selection	0 (Normal load)
00-20	Master frequency command source (AUTO)	2 (External analog input)
00-21	Operation command source (AUTO)	1 (External terminals)
00-23	Control of motor direction	1 (Disable reverse)
01-00	Motor 1 maximum operation frequency	Default setting
01-01	Motor 1 output frequency	Default setting
01-02	Motor 1 output voltage	Default setting
01-03	Motor 1 mid-point frequency 1	Default setting
01-04	Motor 1 mid-point voltage 1	Default setting
01-05	Motor 1 mid-point frequency 2	Default setting
01-06	Motor 1 mid-point voltage 2	Default setting
01-07	Motor 1 minimum output frequency	Default setting
01-08	Motor 1 minimum output voltage	Default setting
01-10	Output frequency upper limit	50 (Hz)
01-11	Output frequency lower limit	35 (Hz)
01-12	Acceleration time 1	15 (s)
01-13	Deceleration time 1	15 (s)
01-43	V/F curve selection	2 (Second V/F curve)
07-06	Restart after momentary power loss	2 (Speed tracking by minimum output frequency)
07-11	Number of times of auto-restart after fault	5 (times)
07-33	Auto-restart interval of fault	60 (s)

 Group setting 05: Conveyor

The following table lists the relevant conveyor setting application parameters.

Pr.	Explanation	Settings
00-11	Speed control mode	0 (VF)
00-16	Load selection	0 (Normal load)
00-20	Master frequency command source (AUTO)	2 (External analog input)
00-21	Operation command source (AUTO)	1 (External terminals)
01-00	Motor 1 maximum operation frequency	Default setting
01-01	Motor 1 output frequency	Default setting
01-02	Motor 1 output voltage	Default setting
01-03	Motor 1 mid-point frequency 1	Default setting
01-04	Motor 1 mid-point voltage 1	Default setting
01-05	Motor 1 mid-point frequency 2	Default setting
01-06	Motor 1 mid-point voltage 2	Default setting
01-07	Motor 1 minimum output frequency	Default setting
01-08	Motor 1 minimum output voltage of motor 1	Default setting
01-12	Acceleration time 1	10 (s)
01-13	Deceleration time 1	10 (s)

 Group setting 07: Packing

The following table lists the relevant packing setting application parameters.

Pr.	Explanation	Settings
00-11	Speed control mode	0 (VF)
00-20	Master frequency command source (AUTO)	0 (Digital keypad)
00-21	Operation command source (AUTO)	2 (RS-485 Communication input)
02-00	Two-wire / Three-wire operation control	1 (two-wire mode 1, power on for operation control (M1: FWD / STOP, M2: REV / STOP))
01-00	Motor 1 maximum operation frequency	Default setting
01-01	Motor 1 output frequency	Default setting
01-02	Motor 1 output voltage	Default setting
01-03	Motor 1 mid-point frequency 1	Default setting
01-04	Motor 1 mid-point voltage 1	Default setting
01-05	Motor 1 mid-point frequency 2	Default setting
01-06	Motor 1 mid-point voltage 2	Default setting
01-07	Motor 1 minimum output frequency	Default setting
01-08	Motor 1 minimum output voltage	Default setting
01-12	Acceleration time 1	10 (s)
01-13	Deceleration time 1	10 (s)
01-24	S-curve acceleration begin time 1	Default setting

01-25	S-curve acceleration arrival time 2	Default setting
01-26	S-curve deceleration begin time 1	Default setting
01-27	S-curve deceleration arrival time 2	Default setting
03-00	Analog input selection (AVI)	1 (Frequency command)
03-28	AVI terminal input selection	Default setting

<div style="display: flex; align-items: center;"> <div style="margin-right: 10px;"> <p>13-01</p> <p>—</p> <p>13-50</p> </div> <div> <p>Application Parameters (User-Defined)</p> </div> </div>
--

14 Protection Parameters (2)

✎ You can set this parameter during operation.

14-50	Output Frequency at Malfunction 2
14-54	Output Frequency at Malfunction 3
14-58	Output Frequency at Malfunction 4
14-62	Output Frequency at Malfunction 5
14-66	Output Frequency at Malfunction 6

Default: Read only

Settings 0.00–599.00 Hz

📖 When an error occurs, you can check the output frequency for the malfunction. If the error happens again, this parameter overwrites the previous record.

14-51	DC Voltage at Malfunction 2
14-55	DC Voltage at Malfunction 3
14-59	DC Voltage at Malfunction 4
14-63	DC Voltage at Malfunction 5
14-67	DC Voltage at Malfunction 6

Default: Read only

Settings 0.0–6553.5 V

📖 When an error occurs, you can check the DC voltage for the malfunction. If the error happens again, this parameter overwrites the previous record.

14-52	Output Current at Malfunction 2
14-56	Output Current at Malfunction 3
14-60	Output Current at Malfunction 4
14-64	Output Current at Malfunction 5
14-68	Output Current at Malfunction 6

Default: Read only

Settings 0.00–655.35 Amps

📖 When an error occurs, you can check the output current for the malfunction. If the error happens again, this parameter overwrites the previous record.

14-53	IGBT Temperature at Malfunction 2
14-57	IGBT Temperature at Malfunction 3
14-61	IGBT Temperature at Malfunction 4
14-65	IGBT Temperature at Malfunction 5
14-69	IGBT Temperature at Malfunction 6

Default: Read only

Settings -3276.7–3276.7°C



📖 When an error occurs, you can check the IGBT temperature for the malfunction. If the error happens again, this parameter overwrites the previous record.

14-70	Fault Record 7
14-71	Fault Record 8
14-72	Fault Record 9
14-73	Fault Record 10

Default: 0

- Settings
- 0: No fault record
 - 1: Over-current during acceleration (ocA)
 - 2: Over-current during deceleration (ocd)
 - 3: Over-current during constant speed (ocn)
 - 4: Ground fault (GFF)
 - 6: Over-current at STOP (ocS)
 - 7: Over-voltage during acceleration (ovA)
 - 8: Over-voltage during deceleration (ovd)
 - 9: Over-voltage during constant speed (ovn)
 - 10: Over-voltage at STOP (ovS)
 - 11: Low-voltage during acceleration (LvA)
 - 12: Low-voltage during deceleration (Lvd)
 - 13: Low-voltage during constant speed (Lvn)
 - 14: Low-voltage at STOP (LvS)
 - 15: Phase loss protection (orP)
 - 16: IGBT over-heat (oH1)
 - 18: TH1 open: IGBT over-heat protection error(tH1o)
 - 21: Drive over-load (oL)
 - 22: Electronic thermal relay protection 1 (EoL1)
 - 23: Electronic thermal relay protection 2 (EoL2)
 - 24: Motor PTC over-heat (oH3)
 - 26: Over-torque 1 (ot1)
 - 27: Over-torque 2 (ot2)
 - 28: Low current (uC)
 - 31: Memory read-out error (cF2)
 - 33: U-phase current detection error (cd1)
 - 34: V-phase current detection error (cd2)
 - 35: W-phase current detection error (cd3)
 - 36: Clamp current detection error (Hd0)
 - 37: Over-current detection error (Hd1)
 - 40: Auto-tuning error (AUE)
 - 41: PID feedback loss (AFE)
 - 48: Analog current input loss (ACE)
 - 49: External fault input (EF)
 - 50: Emergency stop (EF1)
 - 51: External Base Block (B.B.)

- 52: Password error (Pcod)
- 54: Communication error (CE1)
- 55: Communication error (CE2)
- 56: Communication error (CE3)
- 57: Communication error (CE4)
- 58: Communication time-out (CE10)
- 61: Y-connection / Δ -connection switch error (ydc)
- 62: Deceleration energy backup error (dEb)
- 72: Channel 1 (S1-DCM) safety loop error (STL1)
- 76: Safe Torque Off (STo)
- 77: Channel 2 (S2-DCM) safety loop error (STL2)
- 78: Internal loop error (STL3)
- 79: U-phase over-current before run (Uoc)
- 80: V-phase over-current before run (Voc)
- 81: W-phase over-current before run (Woc)
- 82: U-phase output phase loss (OPHL)
- 83: V-phase output phase loss (OPHL)
- 84: W-phase output phase loss (OPHL)
- 87: Drive overload in low frequency (oL3)
- 89: Initial rotor position detection error (RoPd)
- 140: GFF detected when power ON (Hd6)
- 141: GFF before run (BGFF)
- 142: Auto-tuning error 1 (DC test stage) (AUE1)
- 143: Auto-tuning error 2 (high frequency test stage) (AUE2)
- 144: Auto-tuning error 3 (rotary test stage) (AUE3)

-
-  The system records the fault as long as the fault is forced to stop.
 -  Low voltage (Lv) when stopped (LvS warning, no record); low voltage (Lv) when operating (LvA, Lvd, Lvn error, recorded by the system).
 -  When the dEb function is effective and enabled, the drive starts the dEb function and also records the fault code 62 to Pr.06-17-06-22, Pr.14-70-14-73 at the same time.

[This page intentionally left blank]

12-2 Adjustment & Application

Standard PM Motor Adjustment Procedure

- Pr.00-11 Speed Control Mode = 2 SVC (Pr.05-33 = 1 or 2)

Adjustment flow chart when starting up WITHOUT load

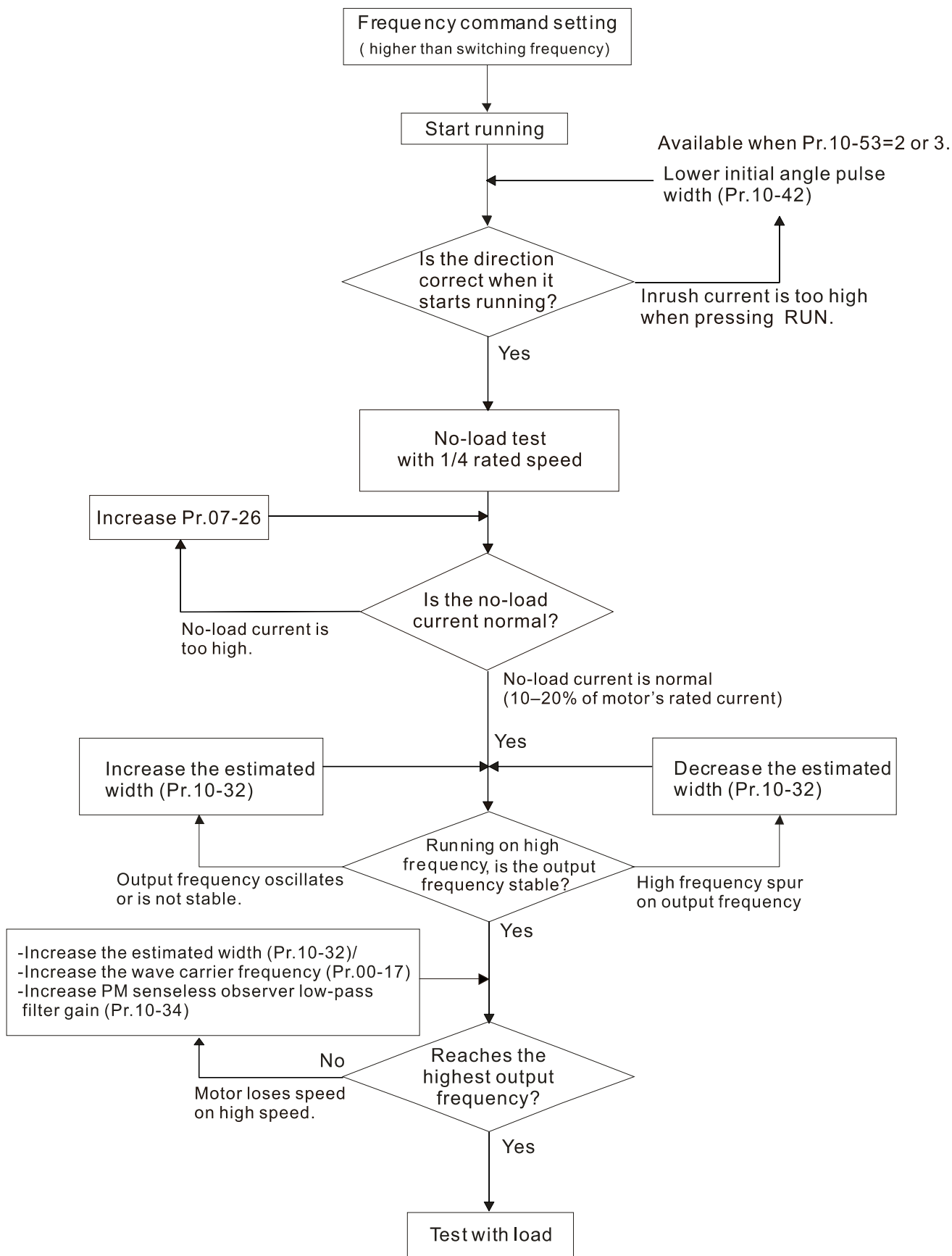

Adjustment flow chart when starting up WITH load

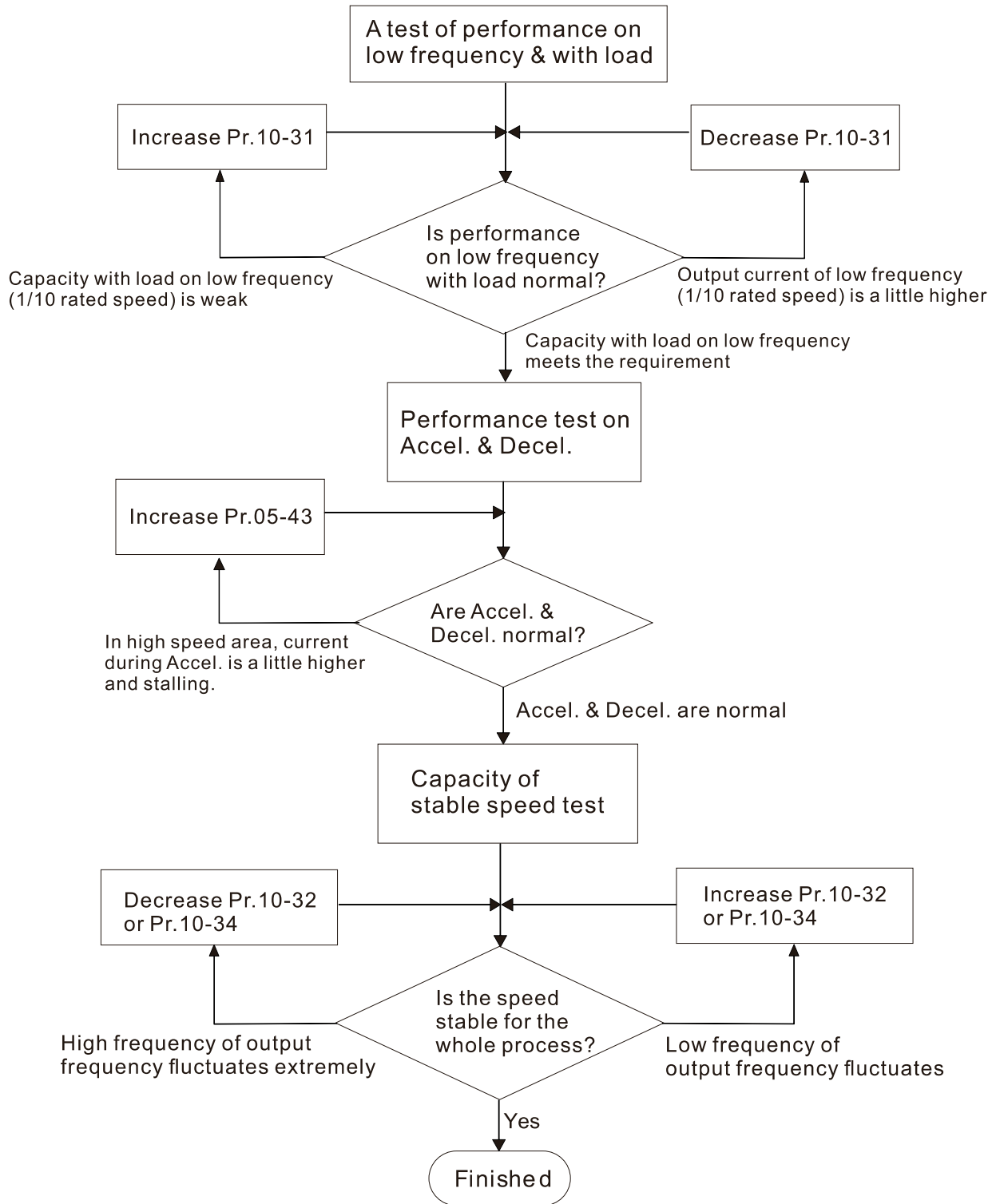

PMSVC control diagram

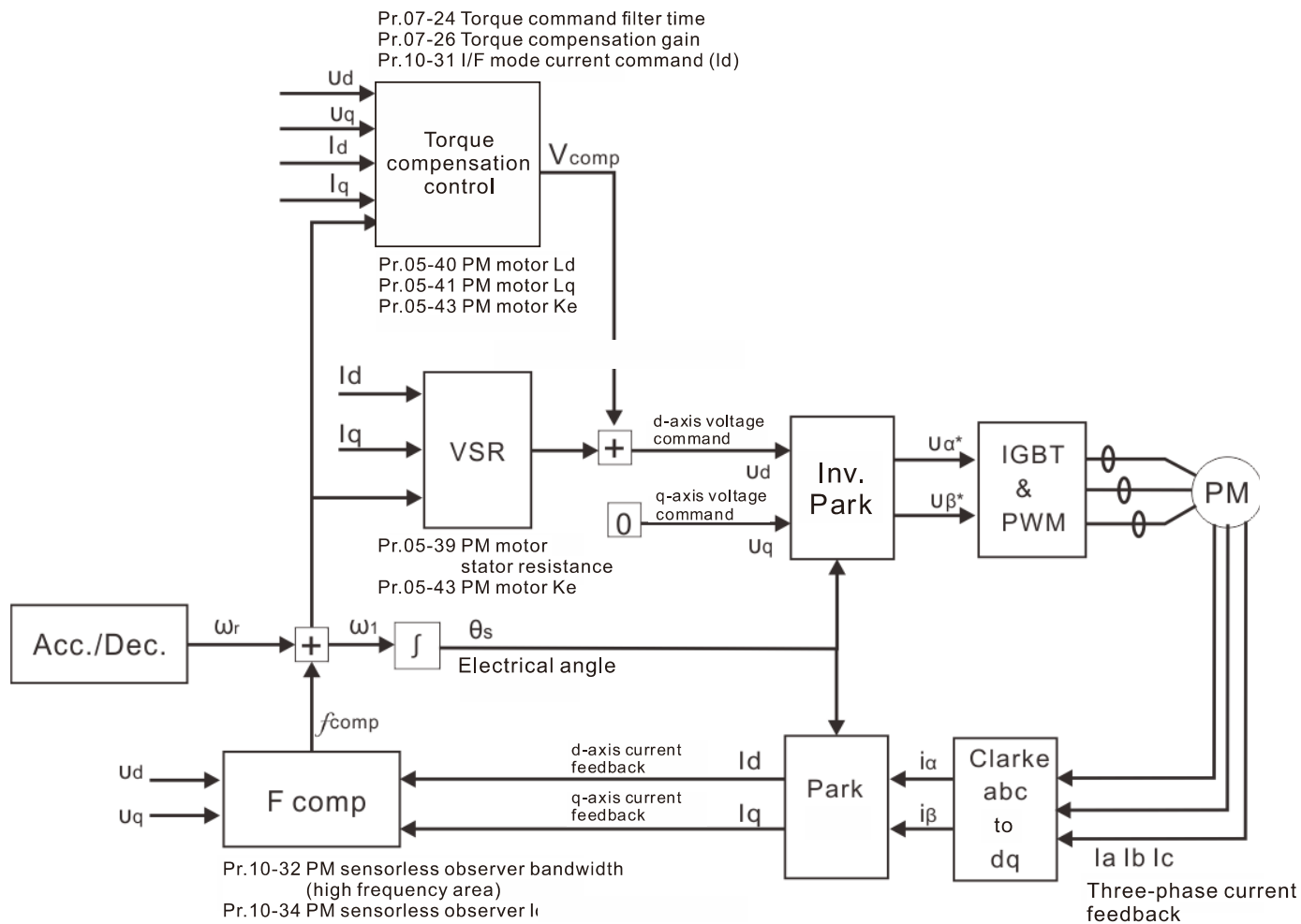

Adjustment procedure

1. Select PM motor control
Pr.05-33 Induction Motor (IM) or Permanent Magnet Synchronous Motor Selection =1 (SPM) or 2 (IPM)
2. Set up motor parameters according to the motor's nameplate
Pr.01-01: Rated frequency
Pr.01-02: Rated voltage
Pr.05-34: Rated current
Pr.05-35: Rated Power
Pr.05-36: Rated speed
Pr.05-37: Number of poles for the motor
3. Execute PM Auto-tuning (static)
Set Pr.05-00 Motor Parameter Auto-Tuning =13 (High frequency stall test for PM synchronous motor) and press RUN.
When you finish tuning, the following parameters are available:
Pr.05-39: Stator resistance
Pr.05-40: Permanent magnet motor Ld
Pr.05-41: Permanent magnet motor Lq
Pr.05-43: ($V / 1000 \text{ rpm}$), the Ke parameter of PM motor (you can calculate this automatically according to power, current, and speed of the motor).
Pr.10-52: The amplitude of the high frequency signal injected during angle detection.
4. Set the speed control mode: Pr.00-10 Control Mode = 0, Pr.00-11 Speed Control Mode = 2 SVC.
5. Cut off the power after you finish tuning, and then restart.
6. The ratio of the PMSVC control mode is 1:20.
7. When the PMSVC control mode is under 1/20th of the rated speed, the load bearing capacity is 100% of the motor rated torque.
8. PMSVC control mode is not applicable to zero speed control.
9. Start-up with load and forward/reverse load bearing capacity of PMSVC control mode equal to 100% of the rated torque of motor.
10. Set up the speed estimators related parameters.
Pr.10-31 I/F Mode, Current Command
Pr.10-32 PM FOC Sensorless Speed Estimator Bandwidth
Pr.10-34 PM Sensorless Speed Estimator Low-pass Filter Gain
Pr.10-42 Initial Angle Detection Pulse Value
Pr.10-49 Zero Voltage Time during Start-up
Pr.10-51 Injection Frequency
Pr.10-52 Injection Magnitude
Pr.10-53 Position Detection Method
11. Speed adjustment parameter
Pr.07-26 Torque Compensation Gain

Chapter 13 Warning Codes

ID No.	Display on LCM Keypad	Warning Name	Description
1	CE1	Communication error 1 (CE1)	RS-485 Modbus illegal function code
Action and Reset			
Action level		When the function code is not 03, 06, 10 and 63.	
Action time		Immediately	
Warning treatment parameter		N/A	
Reset method		"Warning" occurs when Pr.09-02=0 and the motor drive keeps running. The drive resets automatically when receiving the correct function code.	
Reset condition		Immediately reset	
Record		N/A	
Cause		Corrective Actions	
Incorrect communication command from the upper unit		Check if the communication command is correct.	
Malfunction caused by interference		Verify the wiring and grounding of the communication circuit. It is recommended to separate the communication circuit from the main circuit, or wire in 90 degree for effective anti-interference performance.	
Different communication setting from the upper unit		Check if the setting for Pr.09-02 is the same as the setting for the upper unit.	
Disconnection or bad connection of the cable		Check the cable and replace it if necessary.	

ID No.	Display on LCM Keypad	Warning Name	Description
2	CE2	Communication error 2 (CE2)	RS-485 Modbus illegal data address (00–254 H)
Action and Reset			
Action level		When the input data address is incorrect.	
Action time		Immediately	
Warning treatment parameter		N/A	
Reset method		"Warning" occurs when Pr.09-02=0 and the motor drive keeps running. The drive resets automatically when receiving the correct data address.	
Reset condition		Immediately reset	
Record		N/A	
Cause		Corrective Actions	
Incorrect communication command from the upper unit		Check if the communication command is correct.	
Malfunction caused by interference		Verify the wiring and grounding of the communication circuit. It is recommended to separate the communication circuit from the main circuit, or wire in 90 degree for effective anti-interference performance.	
Different communication setting from the upper unit		Check if the setting for Pr.09-02 is the same as the setting for the upper unit.	
Disconnection or bad connection of the cable		Check the cable and replace it if necessary.	

ID No.	Display on LCM Keypad	Warning Name	Description
3	CE3	Communication error 3 (CE3)	RS-485 Modbus illegal data value
Action and Reset			
Action level		When the length of communication data is too long.	
Action time		Immediately	
Warning treatment parameter		N/A	
Reset method		"Warning" occurs when Pr.09-02=0 and the motor drive keeps running. The drive resets automatically when receiving the correct communication data value.	
Reset condition		Immediately reset	
Record		N/A	
Cause		Corrective Actions	
Incorrect communication command from the upper unit		Check if the communication command is correct.	

Malfunction caused by interference	Verify the wiring and grounding of the communication circuit. It is recommended to separate the communication circuit from the main circuit, or wire in 90 degree for effective anti-interference performance.
Different communication setting from the upper unit	Check if the setting for Pr.09-02 is the same as the setting for the upper unit.
Disconnection or bad connection of the cable	Check the cable and replace it if necessary.

ID No.	Display on LCM Keypad	Warning Name	Description
4	CE4	Communication error 4 (CE4)	RS-485 Modbus data is written to read-only address.
Action and Reset			
Action level		When the data is written to read-only address.	
Action time		Immediately	
Warning treatment parameter		N/A	
Reset method		"Warning" occurs when Pr.09-02=0 and the motor drive keeps running. The drive resets automatically when receiving the correct written address of communication data.	
Reset condition		Immediately reset	
Record		N/A	
Cause		Corrective Actions	
Incorrect communication command from the upper unit		Check if the communication command is correct.	
Malfunction caused by interference		Verify the wiring and grounding of the communication circuit. It is recommended to separate the communication circuit from the main circuit, or wire in 90 degree for effective anti-interference performance.	
Different communication setting from the upper unit		Check if the setting for Pr.09-02 is the same as the setting for the upper unit.	
Disconnection or bad connection of the cable		Check the cable and replace it if necessary.	

ID No.	Display on LCM Keypad	Warning Name	Description
5	CE10	Communication error 10 (CE10)	RS-485 Modbus transmission time-out
Action and Reset			
Action level		When the communication time exceeds the detection time for Pr.09-33 communication time-out.	
Action time		Settings for Pr.09-03	
Warning treatment parameter		N/A	
Reset method		"Warning" occurs when Pr.09-02=0 and the motor drive keeps running. The drive resets automatically when receiving the next communication packet.	
Reset condition		Immediately reset	
Record		N/A	
Cause		Corrective Actions	
The upper unit does not transmit the communication command within Pr.09-03 setting time.		Check if the upper unit transmits the communication command within the setting time for Pr.09-03.	
Malfunction caused by interference		Verify the wiring and grounding of the communication circuit. It is recommended to separate the communication circuit from the main circuit, or wire in 90 degree for effective anti-interference performance.	
Different communication setting from the upper unit		Check if the setting for Pr.09-02 is the same as the setting for the upper unit.	
Disconnection or bad connection of the cable		Check the cable and replace it if necessary.	
Does not set the communication format when using KPC-CC01.		Set Pr.09-00=1, Pr.09-01=19.2, and Pr.09-04=13.	

ID No.	Display on LCM Keypad	Warning Name	Description
7	SE1	Save error 1 (SE1)	Keypad COPY error 1: keypad copy time-out
Action and Reset			
Action level	"SE1" warning occurs when the keypad does not transmit the COPY command to the drive, and does not transmit any data to the drive again in 10 ms at the time you copy the parameters to the drive.		
Action time	10 ms		
Warning treatment parameter	N/A		
Reset method	Manual reset		
Reset condition	Immediately reset		
Record	N/A		
Cause	Corrective Actions		
Communication connection error	SE1: The causes of error are mostly communication problems between the keypad and control board. Potential causes include communication signal interference and the unacceptable communication command to the Slave. It is not suggested to consider the communication quality at this time. Check if the error occurs randomly, or only occurs when copying certain parameters (the error displays on the upper right corner of the copy page). If you cannot clear the error, please contact Delta.		
Keypad error			
Control board error			

ID No.	Display on LCM Keypad	Warning Name	Description
8	SE2	Save error 2 (SE2)	Keypad COPY error 2: parameter writing error
Action and Reset			
Action level	"SE2" warning occurs when writing the parameters incorrectly at the time you copy the parameters to the drive. For example, you copy the new firmware version with added parameters to the drive with old firmware version.		
Action time	N/A		
Warning treatment parameter	N/A		
Reset method	Manual reset		
Reset condition	Immediately reset		
Record	N/A		
Cause	Corrective Actions		
Add new parameters to the new firmware version.	SE2: In this stage, the copied data has been transmitted to the Slave. The Slave compares and processes the copied data, and then saves the data to the Data ROM. During the process, the data error (should be attribution error) may occur, or the data cannot be saved to EEPROM. At this time, the warning occurs. It is not suggested to consider the Data ROM at this time. If you cannot clear the error, please contact Delta.		
Malfunction caused by interference			
Verify the wiring and grounding of the main circuit, control circuit and the encoder for effective anti-interference performance.			

ID No.	Display on LCM Keypad	Warning Name	Description
9	oH1	IGBT over-heating warning (oH1)	The AC motor drive detects over-heating of IGBT, and over the protection level of oH1 warning. (When Pr.06-15 is higher than the IGBT over-heating level, the drive shows oH1 error without displaying oH1 warning.)
Action and Reset			
Action level	Pr.06-15		
Action time	"oH1" warning occurs when IGBT temperature is higher than Pr.06-15 setting value.		
Warning treatment parameter	N/A		
Reset method	Auto-reset		
Reset condition	The drive auto-resets when IGBT temperature is lower than oH1 warning level minus (-) 5°C.		
Record	N/A		

Cause	Corrective Actions
Check if the ambient temperature or temperature inside the cabinet is too high, or if there is obstruction in the ventilation hole of the control cabinet.	<ol style="list-style-type: none"> 1. Check the ambient temperature. 2. Regularly inspect the ventilation hole of the control cabinet. 3. Change the installed place if there are heating objects, such as braking resistors, in the surroundings. 4. Install/ add cooling fan or air conditioner to lower the temperature inside the cabinet.
Check if there is any obstruction on the heat sink or if the fan is running.	Remove the obstruction or replace the cooling fan.
Insufficient ventilation space	Increase ventilation space of the drive.
Check if the drive matches the corresponded loading.	<ol style="list-style-type: none"> 1. Decrease the loading. 2. Decrease the carrier. 3. Replace with a drive with larger capacity.
The drive has run 100% or more than 100% of the rated output for a long time.	Replace with a drive with larger capacity.

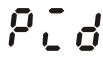
ID No.	Display on LCM Keypad	Warning Name	Description
11		PID feedback error (PID)	PID feedback loss (warning for analog feedback signal; works only when PID enables)
Action and Reset			
Action level		When the analog input is lower than 4 mA (only detects analog input 4–20 mA).	
Action time		Pr.08-08	
Warning treatment parameter		Pr.08-09 0: Warn and keep operation 1: Warn and ramp to stop 2: Warn and coast to stop 3: Warn and operate at last frequency	
Reset method		Auto	“Warning” occurs when Pr.08-09=0 or 3. The “Warning” automatically clears when the feedback signal is larger than 4 mA.
		Manual	“Error” occurs when Pr.08-09=1 or 2. You must reset manually.
Reset condition		Immediately reset	
Record		Records when Pr.08-09=1 or 2 (“Error”). Does not record when Pr.08-09=0 or 3 (“Warning”).	
Cause		Corrective Actions	
Loose or broken PID feedback wiring		Tighten the terminals again. Replace with a new cable.	
Feedback device malfunction		Replace with a new feedback device.	
Hardware error		If the PID error still occurs after checking all the wiring, send the drive back to the factory for repair.	

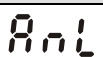
ID No.	Display on LCM Keypad	Warning Name	Description
12		ACI analog signal loss (AnL)	Analog input current loss (including all analog 4–20 mA signals)
Action and Reset			
Action level		When the analog input is lower than 4 mA (only detects analog input 4–20 mA)	
Action time		Immediately act	
Warning treatment parameter		Pr.03-19 0: Disable 1: Continue operation at the last frequency (warning, the keypad displays “ANL”) 2: Decelerate to 0 Hz (warning, the keypad displays “ANL”) 3: Stop immediately and display “ACE”	
Reset method		Auto	“Warning” occurs when Pr.03-19=1 or 2. The “Warning” automatically clears when the analog input signal is larger than 4 mA.
		Manual	“Error” occurs when Pr.03-19=3. You must reset manually.
Reset condition		Immediately reset	
Record		Does not record when Pr.03-19=1 or 2 (“Warning”).	
Cause		Corrective Actions	
Loose or broken ACI wiring		Tighten the terminals again. Replace with a new cable.	

External device error	Replace with a new device.
Hardware error	If the AnL error still occurs after checking all the wiring, send the drive back to the factory for repair.

ID No.	Display on LCM Keypad	Warning Name	Description
13		Under current (uC)	Low current
Action and Reset			
Action level		Pr.06-71	
Action time		Pr.06-72	
Warning treatment parameter		Pr.06-73 0: No function 1: Warn and coast to stop 2: Warn and ramp to stop by 2 nd deceleration time 3: Warn and continue operation	
Reset method		Auto	"Warning" occurs when Pr.06-73=3. The "Warning" automatically clears when the output current is > (Pr.06-71+0.1 A).
		Manual	"Error" occurs when Pr.06-73=1 and 2. You must reset manually.
Reset condition		Immediately reset	
Record		Does not record when Pr.06-73=3 and uC displays "Warning".	
Cause		Corrective Actions	
Broken motor cable		Exclude the connection issue of the motor and its load.	
Improper setting for the low current protection		Set the proper settings for Pr.06-71, Pr.06-72 and Pr.06-73.	
Low load		Check the loading status. Make sure the loading matches the motor capacity.	

ID No.	Display on LCM Keypad	Warning Name	Description
20		Over-torque 1 (ot1)	Over-torque 1 warning
Action and Reset			
Action level		Pr.06-07	
Action time		Pr.06-08	
Warning treatment parameter		Pr.06-06=1 or 3 0: No function 1: Continue operation after over-torque detection during constant speed operation 2: Stop after over-torque detection during constant speed operation 3: Continue operation after over-torque detection during RUN 4: Stop after over-torque detection during RUN	
Reset method		When input current < (Pr.06-07 – 5%), the Ot1 warning automatically clears.	
Reset condition		When input current < (Pr.06-07 – 5%), the Ot1 warning automatically clears.	
Record		N/A	
Cause		Corrective Actions	
Incorrect parameter setting		Configure the settings for Pr.06-07 and 06-08 again.	
Mechanical error (e.g. mechanical lock due to over-torque)		Remove the causes of malfunction.	
The load is too large.		Decrease the loading. Replace with a motor with larger capacity.	
Accel./ Decel. time and working cycle is too short.		Increase the setting values for Pr.01-12–01-19 (accel./ decel. time).	
V/F voltage is too high.		Adjust the settings for Pr.01-01–01-08 (V/F curve), especially the setting value for the mid-point voltage (if the mid-point voltage is set too small, the load capacity decreases at low-speed).	
The motor capacity is too small.		Replace with a motor with larger capacity.	
Over-load during low-speed operation.		Decrease the loading during low-speed operation. Increase the motor capacity.	
The torque compensation is too large.		Readjust the torque compensation value (Pr.07-26 torque compensation gain) till the output current decreases and the motor does not stall.	

Improper parameter settings for the speed tracking function (including restart after momentary power loss and restart after fault)	Correct the parameter settings for speed tracking. Start the speed tracking function. Adjust the maximum current for Pr.07-09 speed tracking.
--	---

ID No.	Display on LCM Keypad	Warning Name	Description
21	ot2	Over-torque (ot2)	Over-torque 2 warning
Action and Reset			
Action level		Pr.06-10	
Action time		Pr.06-11	
Warning treatment parameter		Pr.06-09=1 or 3 0: No function 1: Continue operation after over-torque detection during constant speed operation 2: Stop after over-torque detection during constant speed operation 3: Continue operation after over-torque detection during RUN 4: Stop after over-torque detection during RUN	
Reset method		When output current < (Pr.06-10 – 5%), the Ot2 warning automatically clears.	
Reset condition		When output current < (Pr.06-10 – 5%), the Ot2 warning automatically clears.	
Record		N/A	
Cause		Corrective Actions	
Incorrect parameter setting		Configure the settings for Pr.06-10 and 06-11 again.	
Mechanical error (e.g. mechanical lock due to over-torque)		Remove the causes of malfunction.	
The load is too large.		Decrease the loading. Replace with a motor with larger capacity.	
Accel./ Decel. time and working cycle is too short.		Increase the setting values for Pr.01-12–01-19 (accel./ decel. time).	
V/F voltage is too high.		Adjust the settings for Pr.01-35–01-42 (V/F curve), especially the setting value for the mid-point voltage (if the mid-point voltage is set too small, the load capacity decreases at low-speed).	
The motor capacity is too small.		Replace with a motor with larger capacity.	
Over-load during low-speed operation.		Decrease the loading during low-speed operation. Increase the motor capacity.	
The torque compensation is too large.		Readjust the torque compensation value (Pr.07-26 torque compensation gain) till the output current decreases and the motor does not stall.	
Improper parameter settings for the speed tracking function (including restart after momentary power loss and restart after fault)		Correct the parameter settings for speed tracking. Start the speed tracking function. Adjust the maximum current for Pr.07-09 speed tracking.	

ID No.	Display on LCM Keypad	Warning Name	Description
22_1	oH3	Motor over-heating (oH3) PTC	Motor over-heating warning. The AC motor drive detects the temperature inside the motor is too high.
Action and Reset			
Action level		Pr.03-00=6 (PTC), PTC input level > Pr.06-30 (default=50%).	
Action time		Immediately act	
Warning treatment parameter		Error treatment: Pr.06-29 0: Warn and continue operation 1: Warn and ramp to stop 2: Warn and coast to stop 3: No warning When Pr.06-29=0 and when the temperature is ≤ Pr.06-30 level, the oH3 warning automatically clears. When Pr.06-29=0 (“Warning”), it automatically resets.	
Reset method		When Pr.06-29=0, oH3 displays “Warning”. When the temperature is ≤ Pr.06-30 level, the oH3 warning automatically clears.	
Reset condition		When the temperature is ≤ Pr.06-30 level, the oH3 warning automatically clears.	
Record		N/A	

Cause	Corrective Actions
Motor locked.	Clear the motor lock status.
The load is too large.	Decrease the loading. Replace with a motor with larger capacity.
Ambient temperature is too high.	Change the installed place if there are heating devices in the surroundings. Install/ add cooling fan or air conditioner to lower the ambient temperature.
Motor cooling system error	Check the cooling system to make it work normally.
Motor fan error	Replace the fan.
Operates at low-speed too long.	Decrease low-speed operation time. Change to the dedicated motor for the drive. Increase the motor capacity.
Accel./ Decel. time and working cycle is too short.	Increase the setting values for Pr.01-12-01-19 (accel./ decel. time).
V/F voltage is too high.	Adjust the settings for Pr.01-01-01-08 (V/F curve), especially the setting value for the mid-point voltage (if the mid-point voltage is set too small, the load capacity decreases at low-speed).
Check if the motor rated current matches the motor nameplate.	Configure the correct rated current value of the motor again.
Check if the PTC is properly set and wired.	Check the connection between PTC thermistor and the heat protection.
Check if the setting for stall prevention is correct.	Set the stall prevention to the proper value.
Unbalanced three-phase impedance of the motor	Replace the motor.
Harmonics are too high.	Use remedies to reduce harmonics.

ID No.	Display on LCM Keypad	Warning Name	Description
22_2	oH3	Motor over-heating (oH3) PT100	Motor over-heating warning. The AC motor drive detects the temperature inside the motor is too high.
Action and Reset			
Action level		Pr.03-00=11 (PT100), PT100 input level > Pr.06-57 (default=7 V).	
Action time		Immediately act	
Warning treatment parameter		Error treatment: Pr.06-29 0: Warn and continue operation 1: Warn and ramp to stop 2: Warn and coast to stop 3: No warning When Pr.06-29=0 and when the temperature is < Pr.06-56 level, the oH3 warning automatically clears. If the temperature is between Pr.06-56 and Pr.06-57, the frequency outputs according to the operating frequency setting for Pr.06-58.	
Reset method		When Pr.06-29=0, oH3 displays "Warning". When the temperature is < Pr.06-56 level, the oH3 warning automatically clears.	
Reset condition		When the temperature is < Pr.06-56 level, the oH3 warning automatically clears.	
Record		N/A	
Cause		Corrective Actions	
Motor locked.		Clear the motor lock status.	
The load is too large.		Decrease the loading. Replace with a motor with larger capacity.	
Ambient temperature is too high.		Change the installed place if there are heating devices in the surroundings. Install/ add cooling fan or air conditioner to lower the ambient temperature.	
Motor cooling system error		Check the cooling system to make it work normally.	
Motor fan error		Replace the fan.	
Operates at low-speed too long.		Decrease low-speed operation time. Change to the dedicated motor for the drive. Increase the motor capacity.	
Accel./ Decel. time and working cycle is too short.		Increase the setting values for Pr.01-12-01-19 (accel./ decel. time).	

V/F voltage is too high.	Adjust the settings for Pr.01-01-01-08 (V/F curve), especially the setting value for the mid-point voltage (if the mid-point voltage is set too small, the load capacity decreases at low-speed).
Check if the motor rated current matches the motor nameplate.	Configure the correct rated current value of the motor again.
Check if the PT100 is properly set and wired.	Check the connection between PT100 thermistor and the heat protection.
Check if the setting for stall prevention is correct.	Set the stall prevention to the proper value.
Unbalanced three-phase impedance of the motor	Replace the motor.
Harmonics are too high.	Use remedies to reduce harmonics.

ID No.	Display on LCM Keypad	Warning Name	Description
24	oSL	Over-slip warning (oSL)	Over-slip warning. By using the maximum slip (Pr.10-29) as the base, when the drive outputs at constant speed, and the F>H or F<H exceeds Pr.07-29 level and Pr.07-30 setting time, 100% of Pr.07-29 = Pr.10-29.
Action and Reset			
Action level		When the drive outputs at constant speed, and F>H or F<H exceeds the Pr.07-29 level.	
Action time		Pr.07-30	
Warning treatment parameter		Pr.07-31=0 Warning 0: Warn and continue operation 1: Warn and ramp to stop 2: Warn and coast to stop 3: No warning	
Reset method		When Pr.07-31=0 and when the drive outputs at constant speed, and F>H or F<H no longer exceeds the Pr.07-29 level, the oSL warning automatically clears.	
Reset condition		N/A	
Record		N/A	
Cause		Corrective Actions	
Check if the motor parameter is correct.		Check the motor parameter.	
The load is too large.		Decrease the loading.	
Check if the settings for Pr.07-29, Pr.07-30 and Pr.10-29 are properly set.		Check the parameter settings for oSL protection.	

ID No.	Display on LCM Keypad	Warning Name	Description
25	tUn	Auto-tuning (tUn)	Parameter auto-tuning is processing. When running auto-tuning, the keypad displays "tUn".
Action and Reset			
Action level		When running Pr.05-00 motor parameter auto-tuning, the keypad displays "tUn".	
Action time		N/A	
Warning treatment parameter		N/A	
Reset method		When auto-tuning is finished and no error occurs, the warning automatically clears.	
Reset condition		When auto-tuning is finished and no error occurs.	
Record		N/A	
Cause		Corrective Actions	
The motor parameter is running auto-tuning.		When the auto-tuning is finished, the warning automatically clears.	

ID No.	Display on LCM Keypad	Warning Name	Description
28	OPHL	Output phase loss (OPHL)	Output phase loss
Action and Reset			
Action level		Pr.06-47	
Action time		N/A	
Warning treatment parameter		Pr.06-45 0: Warn and continue operation 1: Warn and ramp to stop 2: Warn and coast to stop 3: No warning	
Reset method		If Pr.06-45 is set to 0, the OPHL warning automatically clears after the drive stops.	
Reset condition		N/A	
Record		N/A	
Cause		Corrective Actions	
Unbalanced three-phase impedance of the motor		Replace the motor.	
Check if the wiring is incorrect.		Check the cable. Replace the cable.	
Check if the motor is a single-phase motor.		Choose a three-phase motor.	
Check if the current sensor is broken.		Check if the control board cable is loose. If yes, reconnect the cable and run the drive to test. If the error still occurs, send the drive back to the factory for repair. Check if the three-phase current is balanced with a current clamp meter. If the current is balanced and the OPHL error still shows on the display, send the drive back to the factory for repair.	
Check if the drive capacity is larger than the motor capacity.		Choose the drive that matches the motor capacity.	

ID No.	Display on LCM Keypad	Warning Name	Description
30	SE3	Save error 3 (SE3)	Keypad COPY error 3: copy model error
Action and Reset			
Action level		"SE3" warning occurs when different drive identity codes are found during copying parameters.	
Action time		Immediately act when the error is detected.	
Warning treatment parameter		N/A	
Reset method		Manual reset	
Reset condition		N/A	
Record		N/A	
Cause		Corrective Actions	
Keypad copy between different power range drives		It is mainly to prevent parameter copies between different HP/ models.	

[This page intentionally left blank]

Chapter 14 Fault Codes and Descriptions

ID No.	Display on LCM Keypad	Fault Name	Fault Descriptions
1	ocA	Over-current during acceleration (ocA)	Output current exceeds 2.5 times of the rated current during acceleration. When ocA occurs, the drive closes the gate of the output immediately, the motor runs freely, and the display shows an ocA error.
Action and Reset			
Action level		250% of the rated current (software)	
Action time		Immediately act	
Fault treatment parameter		N/A	
Reset method		Manual reset	
Reset condition		Reset in 5 sec. after the fault is cleared.	
Record		Yes	
Cause		Corrective Actions	
Acceleration time is too short.		<ol style="list-style-type: none"> Increase the acceleration time Increase the acceleration time of S-curve Set auto-acceleration and auto-deceleration parameter (Pr.01-44) Set over-current stall prevention function (Pr.06-03) Replace the drive with a larger capacity model 	
Short-circuit at motor output due to poor insulation wiring.		Without considering the short circuits, check the motor cable or replace the cable before turning on the power.	
Check for possible burnout or aging insulation of the motor		Check the motor insulation value with megger. Replace the motor if the insulation is poor.	
The load is too large.		Check if the output current during the whole working process exceeds the AC motor drive's rated current. If yes, replace the AC motor drive with a larger capacity model.	
Impulsive change of the load		Reduce the load or increase the capacity of the AC motor drive.	
Use special motor or motor with larger capacity than the drive		Check the motor capacity (the rated current on the motor's nameplate should \leq the rated current of the drive)	
Use ON/OFF controller of an electromagnetic contactor at the output (U/V/W) of the drive		Check the action timing of the contactor and make sure it is not turned ON/OFF when the drive outputs the voltage.	
V/F curve setting error		Adjust V/F curve settings and frequency/voltage. When the fault occurs, and the frequency voltage is too high, reduce the voltage.	
Torque compensation is too large.		Adjust the torque compensation (refer to Pr.07-26 torque compensation gain) until the output current reduces and the motor does not stall.	
Malfunction caused by interference		Verify the wiring of the control circuit and wiring/grounding of the main circuit to prevent interference.	
The motor starts when in free run.		Enable the speed tracking during start-up of Pr.07-12.	
Improper parameter settings for the speed tracking function (including restart after momentary power loss and restart after fault)		Correct the parameter settings for speed tracking. <ol style="list-style-type: none"> Start the speed tracking function. Adjust the maximum current for Pr.07-09 speed tracking. 	
Incorrect combination of control mode and used motor		Check the settings for Pr.00-11 control mode: <ol style="list-style-type: none"> For IM motor, Pr.00-11=0, 2, Pr.05-33=0 For PM motor, Pr.00-11=2, Pr.05-33=1, 2 	
The length of motor cable is too long.		Increase the AC motor drive's capacity. Install AC reactor(s) on the output side (U/V/W).	
Hardware failure		The ocA occurs due to short circuit or ground fault at the output side of the drive. Check for possible short circuits between terminals with the electric meter: B1 corresponds to U, V, W; DC- corresponds to U, V, W; \oplus corresponds to U, V, W. If short circuits occur, return to the factory for repair.	
Check if the setting for stall prevention is correct.		Set the stall prevention to the proper value.	

ID No.	Display on LCM Keypad	Fault Name	Fault Descriptions
2	o c d	Over-current during deceleration (ocd)	Output current exceeds 2.5 times of the rated current during deceleration. When ocd occurs, the drive closes the gate of the output immediately, the motor runs freely, and the display shows an ocd error.
Action and Reset			
Action level		250% of the rated current	
Action time		Immediately act	
Fault treatment parameter		N/A	
Reset method		Manual reset	
Reset condition		Reset in 5 sec. after the fault is cleared.	
Record		Yes	
Cause		Corrective Actions	
Deceleration time is too short.		1. Increase the deceleration time 2. Increase the deceleration time of S-curve 3. Set auto-acceleration and auto-deceleration parameter (Pr.01-44) 4. Set over-current stall prevention function (Pr.06-03) 5. Replace the drive with a larger capacity model	
Check if the mechanical brake of the motor activates too early		Check the action timing of the mechanical brake	
Short-circuit at motor output due to poor insulation wiring.		Without considering the short circuits, check the motor cable or replace the cable before turning on the power.	
Check for possible burnout or aging insulation of the motor		Check the motor insulation value with megger. Replace the motor if the insulation is poor.	
The load is too large.		Check if the output current during the whole working process exceeds the AC motor drive's rated current. If yes, replace the AC motor drive with a larger capacity model.	
Impulsive change of the load		Reduce the load or increase the capacity of the AC motor drive.	
Use special motor or motor with larger capacity than the drive		Check the motor capacity (the rated current on the motor's nameplate should ≤ the rated current of the drive)	
Use ON/OFF controller of an electromagnetic contactor at the output (U/V/W) of the drive		Check the action timing of the contactor and make sure it is not turned ON/OFF when the drive outputs the voltage.	
V/F curve setting error		Adjust V/F curve settings and frequency/voltage. When the fault occurs, and the frequency voltage is too high, reduce the voltage.	
Torque compensation is too large.		Adjust the torque compensation (refer to Pr.07-26 torque compensation gain) until the output current reduces and the motor does not stall.	
Malfunction caused by interference		Verify the wiring of the control circuit and wiring/grounding of the main circuit to prevent interference.	
The length of motor cable is too long.		Increase the AC motor drive's capacity. Install AC reactor(s) on the output side (U/V/W).	
Hardware failure		The ocd occurs due to short circuit or ground fault at the output side of the drive. Check for possible short circuits between terminals with the electric meter: B1 corresponds to U, V, W; DC- corresponds to U, V, W; ⊕ corresponds to U, V, W. If short circuits occur, return to the factory for repair.	
Check if the setting for stall prevention is correct.		Set the stall prevention to the proper value.	

ID No.	Display on LCM Keypad	Fault Name	Fault Descriptions
3	o c n	Over-current during steady operation (ocn)	Output current exceeds 2.5 times of the rated current during constant speed. When ocn occurs, the drive closes the gate of the output immediately, the motor runs freely, and the display shows an ocn error.
Action and Reset			
Action level		250% of the rated current	
Action time		Immediately act	
Fault treatment parameter		N/A	
Reset method		Manual reset	
Reset condition		Reset in 5 sec. after the fault is cleared.	
Record		Yes	

Cause	Corrective Actions
Short-circuit at motor output due to poor insulation wiring.	Without considering the short circuits, check the motor cable or replace the cable before turning on the power.
Check for possible shaft lock, burnout or aging insulation of the motor	Troubleshoot the motor shaft lock. Check the motor insulation value with megger. Replace the motor if the insulation is poor.
Impulsive change of the load	Reduce the load or increase the capacity of the AC motor drive.
Use special motor or motor with larger capacity than the drive	Check the motor capacity (the rated current on the motor's nameplate should ≤ the rated current of the drive).
Use ON/OFF controller of an electromagnetic contactor at the output (U/V/W) of the drive	Check the action timing of the contactor and make sure it is not turned ON/OFF when the drive outputs the voltage.
V/F curve setting error	Adjust V/F curve settings and frequency/voltage. When the fault occurs, and the frequency voltage is too high, reduce the voltage.
Torque compensation is too large.	Adjust the torque compensation (refer to Pr.07-26 torque compensation gain) until the output current reduces and the motor does not stall.
Malfunction caused by interference	Verify the wiring of the control circuit and wiring/grounding of the main circuit to prevent interference.
The length of motor cable is too long.	Increase the AC motor drive's capacity. Install AC reactor(s) on the output side (U/V/W).
Hardware failure	The ocn occurs due to short circuit or ground fault at the output side of the drive. Check for possible short circuits between terminals with the electric meter: B1 corresponds to U, V, W; DC- corresponds to U, V, W; ⊕ corresponds to U, V, W. If short circuits occur, return to the factory for repair.

ID No.	Display on LCM Keypad	Fault Name	Fault Descriptions
4	GFF	Ground fault (GFF)	When (one of) the output terminal(s) is grounded, short circuit current is larger than Pr.06-60 setting value, and the detection time is longer than Pr.06-61 time setting, GFF occurs. NOTE: the short circuit protection is provided for AC motor drive protection, not to protect you.
Action and Reset			
Action level		Pr.06-60 (Default = 60%)	
Action time		Pr.06-61 (Default = 0.10 sec.)	
Fault treatment parameter		N/A	
Reset method		Manual reset	
Reset condition		Reset in 5 sec. after the fault is cleared.	
Record		Yes	
Cause		Corrective Actions	
Motor burnout or aging insulation occurred.		Check the motor insulation value with megger. Replace the motor if the insulation is poor.	
Short circuit due to broken cable		Troubleshoot the short circuit. Replace the cable.	
Larger stray capacitance in the cable and terminal ⊕		If the motor cable length exceeds 100 m, decrease the setting value for carrier frequency. Take remedies to reduce stray capacitance.	
Malfunction caused by interference		Verify the grounding and wiring of the communication circuit. It is recommended to separate the communication circuit from the main circuit, or wire in 90 degree for effective sufficient anti-interference performance.	
Hardware failure		Cycle the power after checking the status of motor, cable and cable length. If GFF still exists, return to the factory for repair.	

ID No.	Display on LCM Keypad	Fault Name	Fault Descriptions
6	ocS	Over-current at stop (ocS)	Over-current or hardware failure in current detection at stop. Cycle the power after ocS occurs. If the hardware failure occurs, the display shows cd1, cd2 or cd3.
Action and Reset			
Action level		240% of the rated current	
Action time		Immediately act	
Fault treatment parameter		N/A	

Reset method	Manual reset
Reset condition	Reset in 5 sec. after the fault is cleared.
Record	Yes
Cause	Corrective Actions
Malfunction caused by interference	Verify the wiring of the control circuit and wiring/grounding of the main circuit to prevent interference.
Hardware failure	Check if other error codes such as cd1–cd3 occur after cycling the power. If yes, return to the factory for repair.

ID No.	Display on LCM Keypad	Fault Name	Fault Descriptions
7	ovA	Over-voltage during acceleration (ovA)	DC BUS over-voltage during acceleration. When ovA occurs, the drive closes the gate of the output, the motor runs freely, and the display shows an ovA error.
Action and Reset			
Action level	230V series: 410 V _{DC} 460V series: 820 V _{DC}		
Action time	Immediately act when DC BUS voltage is higher than the level.		
Fault treatment parameter	N/A		
Reset method	Manual reset		
Reset condition	Reset only when DC BUS voltage is lower than 90% of the over-voltage level.		
Record	Yes		
Cause	Corrective Actions		
Acceleration is too slow (e.g. when lifting load decreases acceleration time)	Decrease the acceleration time. Use brake unit or DC BUS. Replace the drive with a larger capacity model.		
The setting for stall prevention level is smaller than no-load current.	The setting for stall prevention level should be larger than no-load current.		
Power voltage is too high.	Check if the input voltage is within the rated AC motor drive input voltage range, and check for possible voltage spikes.		
ON/OFF switch action of phase-in capacitor in the same power system	If the phase-in capacitor or active power supply unit acts in the same power system, the input voltage may surge abnormally in a short time. In this case, install an AC reactor.		
Regenerative voltage of motor inertia	Use over-voltage stall prevention function (Pr.06-01) Use auto-acceleration and auto-deceleration setting (Pr.01-44) Use a brake unit or DC BUS		
Acceleration time is too short.	Check if the over-voltage warning occurs after acceleration stops. When the warning occurs, do the following: 1. Increase the acceleration time 2. Set Pr.06-01 over-voltage stall prevention 3. Increase the setting value for Pr.01-25 S-curve acceleration arrival time 2		
Motor ground fault	The ground short circuit current charges the capacitor in the main circuit through the power. Check if there is ground fault on the motor cable, wiring box and its internal terminals. Troubleshoot the ground fault.		
Incorrect wiring of brake resistor or brake unit	Check the wiring of brake resistor or brake unit.		
Malfunction caused by interference	Verify the wiring of the control circuit and wiring/grounding of the main circuit to prevent interference.		

ID No.	Display on LCM Keypad	Fault Name	Fault Descriptions
8	ovd	Over-voltage during deceleration (ovd)	DC BUS over-voltage during deceleration. When ovd occurs, the drive closes the gate of the output, the motor runs freely, and the display shows an ovd error.
Action and Reset			
Action level	230V series: 410 V _{DC} 460V series: 820 V _{DC}		
Action time	Immediately act when DC BUS voltage is higher than the level.		
Fault treatment parameter	N/A		
Reset method	Manual reset		
Reset condition	Reset only when DC BUS voltage is lower than 90% of the over-voltage level.		
Record	Yes		

Cause	Corrective Actions
Deceleration time is too short, causing too large regenerative energy of the load.	<ol style="list-style-type: none"> 1. Increase the setting value for Pr.01-13, Pr.01-15, Pr.01-17 and Pr.01-19 (deceleration time). 2. Connect brake resistor, brake unit or DC BUS to the drive. 3. Reduce the brake frequency. 4. Replace the drive with a larger capacity model. 5. Use S-curve acceleration/deceleration. 6. Use over-voltage stall prevention (Pr.06-01). 7. Use auto-acceleration and auto-deceleration (Pr.01-44). 8. Adjust braking level (Pr.07-01 or the bolt position of the brake unit).
The setting for stall prevention level is smaller than no-load current.	The setting for stall prevention level should be larger than no-load current.
Power voltage is too high.	Check if the input voltage is within the rated AC motor drive input voltage range, and check for possible voltage spikes.
ON/OFF switch action of phase-in capacitor in the same power system	If the phase-in capacitor or active power supply unit acts in the same power system, the input voltage may surge abnormally in a short time. In this case, install an AC reactor.
Motor ground fault	The ground short circuit current charges the capacitor in the main circuit through the power. Check if there is ground fault on the motor cable, wiring box and its internal terminals. Troubleshoot the ground fault.
Incorrect wiring of brake resistor or brake unit	Check the wiring of brake resistor or brake unit.
Malfunction caused by interference	Verify the wiring of the control circuit and wiring/grounding of the main circuit to prevent interference.

ID No.	Display on LCM Keypad	Fault Name	Fault Descriptions
9		Over-voltage at constant speed (ovn)	DC BUS over-voltage at constant speed. When ovn occurs, the drive closes the gate of the output, motor runs freely, and the display shows an ovn error.
Action and Reset			
Action level		230V series: 410 V _{DC} 460V series: 820 V _{DC}	
Action time		Immediately act when DC BUS voltage is higher than the level.	
Fault treatment parameter		N/A	
Reset method		Manual reset	
Reset condition		Reset only when DC BUS voltage is lower than 90% of the over-voltage level.	
Record		Yes	
Corrective Actions			
Cause		Corrective Actions	
Impulsive change of the load		<ol style="list-style-type: none"> 1. Connect brake resistor, brake unit or DC BUS to the drive. 2. Reduce the load. 3. Replace the drive with a larger capacity model. 4. Adjust braking level (Pr.07-01 or the bolt position of the brake unit). 	
The setting for stall prevention level is smaller than no-load current.		The setting for stall prevention level should be larger than no-load current.	
Regenerative voltage of motor inertia		Use over-voltage stall prevention function (Pr.06-01) Use a brake unit or DC BUS	
Power voltage is too high.		Check if the input voltage is within the rated AC motor drive input voltage range, and check for possible voltage spikes.	
ON/OFF switch action of phase-in capacitor in the same power system		If the phase-in capacitor or active power supply unit acts in the same power system, the input voltage may surge abnormally in a short time. In this case, install an AC reactor.	
Motor ground fault		The ground short circuit current charges the capacitor in the main circuit through the power. Check if there is ground fault on the motor cable, wiring box and its internal terminals. Troubleshoot the ground fault.	
Incorrect wiring of brake resistor or brake unit		Check the wiring of brake resistor or brake unit.	
Malfunction caused by interference		Verify the wiring of the control circuit and wiring/grounding of the main circuit to prevent interference.	

ID No.	Display on LCM Keypad	Fault Name	Fault Descriptions
10	oV5	Over-voltage at stop (ovS)	Over-voltage at stop
Action and Reset			
Action level		230V series: 410 V _{DC} 460V series: 820 V _{DC}	
Action time		Immediately act when DC BUS voltage is higher than the level.	
Fault treatment parameter		N/A	
Reset method		Manual reset	
Reset condition		Reset only when DC BUS voltage is lower than 90% of the over-voltage level.	
Record		Yes	
Cause		Corrective Actions	
Power voltage is too high.		Check if the input voltage is within the rated AC motor drive input voltage range, and check for possible voltage spikes.	
ON/OFF switch action of phase-in capacitor in the same power system		If the phase-in capacitor or active power supply unit acts in the same power system, the input voltage may surge abnormally in a short time. In this case, install an AC reactor.	
Incorrect wiring of brake resistor or brake unit		Check the wiring of brake resistor or brake unit.	
Malfunction caused by interference		Verify the wiring of the control circuit and wiring/grounding of the main circuit to prevent interference.	
Hardware failure in voltage detection		Check if other error codes such as cd1–cd3 occur after cycling the power. If yes, return to the factory for repair.	
Motor ground fault		The ground short circuit current charges the capacitor in the main circuit through the power. Check if there is ground fault on the motor cable, wiring box and its internal terminals. Troubleshoot the ground fault.	

ID No.	Display on LCM Keypad	Fault Name	Fault Descriptions
11	LvA	Low-voltage during acceleration (LvA)	DC BUS voltage is lower than Pr.06-00 setting value during acceleration.
Action and Reset			
Action level		Pr.06-00 (Default = depending on the model)	
Action time		Immediately act when DC BUS voltage is lower than Pr.06-00.	
Fault treatment parameter		N/A	
Reset method		Manual reset	
Reset condition		Reset when DC BUS voltage is higher than Pr.06-00 + 30 V (230V series) / + 60 V (460V series).	
Record		Yes	
Cause		Corrective Actions	
Power-off		Improve power supply condition.	
Power voltage changes		Adjust voltage to the power range of the drive.	
Start up the motor with large capacity.		Check the power system. Increase the capacity of power equipment.	
The load is too large.		Reduce the load. Increase the drive capacity. Increase the acceleration time.	
DC BUS		Install DC reactor(s).	
Check if there is short circuit plate or any DC reactor installed between terminal +1 and +2.		Connect short circuit plate or DC reactor between terminal +1 and +2. If the error still exists, return to the factory for repair.	

ID No.	Display on LCM Keypad	Fault Name	Fault Descriptions
12	LvD	Low-voltage during deceleration (LvD)	DC BUS voltage is lower than Pr.06-00 setting value during deceleration.
Action and Reset			
Action level		Pr.06-00 (Default = depending on the model)	
Action time		Immediate activate when DC BUS voltage is lower than Pr.06-00.	
Fault treatment parameter		N/A	
Reset method		Manual reset	

Reset condition	Reset when DC BUS voltage is higher than Pr.06-00 + 30 V (230V series) / 60 V (460V series).
Record	Yes
Cause	Corrective Actions
Power-off	Improve power supply condition.
Power voltage changes	Adjust voltage to the power range of the drive.
Start up the motor with large capacity.	Check the power system. Increase the capacity of power equipment.
Sudden load	Reduce the load. Increase the drive capacity.
DC BUS	Install DC reactor(s).

ID No.	Display on LCM Keypad	Fault Name	Fault Descriptions
13		Low-voltage at constant speed (Lvn)	DC BUS voltage is lower than Pr.06-00 setting value at constant speed.
Action and Reset			
Action level		Pr.06-00 (Default = depending on the model)	
Action time		Immediately act when DC BUS voltage is lower than Pr.06-00.	
Fault treatment parameter		N/A	
Reset method		Manual reset	
Reset condition		Reset when DC BUS voltage is higher than Pr.06-00 + 30 V (230V series) / + 60 V (460V series).	
Record		Yes	
Cause		Corrective Actions	
Power-off		Improve power supply condition.	
Power voltage changes		Adjust voltage to the power range of the drive.	
Start up the motor with large capacity.		Check the power system. Increase the capacity of power equipment.	
Sudden load		Reduce the load. Increase the drive capacity.	
DC BUS		Install DC reactor(s).	

ID No.	Display on LCM Keypad	Fault Name	Fault Descriptions
14		Low-voltage at stop (LvS)	1. DC BUS voltage is lower than Pr.06-00 setting value at stop. 2. Hardware failure in voltage detection.
Action and Reset			
Action level		Pr.06-00 (Default = depending on the model)	
Action time		Immediately act when DC BUS voltage is lower than Pr.06-00.	
Fault treatment parameter		N/A	
Reset method		Manual / Auto 230V series: Lv level + 30 V _{DC} + 500 ms 460V series: Lv level + 60 V _{DC} + 500 ms	
Reset condition		500 ms	
Record		Yes	
Cause		Corrective Actions	
Power-off		Improve power supply condition.	
Incorrect drive models		Check if the power specification matches the drive.	
Power voltage changes		Adjust voltage to the power range of the drive. Cycle the power after checking the power. If LvS error still exists, return to the factory for repair.	
Start up the motor with large capacity.		Check the power system. Increase the capacity of power equipment.	
DC BUS		Install DC reactor(s).	

ID No.	Display on LCM Keypad	Fault Name	Fault Descriptions
15		Phase loss protection (OrP)	Phase loss of power input
Action and Reset			
Action level		DC BUS is lower than Pr.07-00, and DC BUS ripple is too high.	
Action time		N/A	

Fault treatment parameter	Pr.06-53
Reset method	Manual reset
Reset condition	Immediately reset when DC BUS is higher than Pr.07-00.
Record	Yes
Cause	Corrective Actions
Phase loss of input power	Correctly install the wiring of the main circuit power.
Single phase power input to three-phase models	Choose the model whose power matches the voltage.
Power voltage changes	If the main circuit power works normally, verify the main circuit. Cycle the power after checking the power. If OrP error still exists, return to the factory for repair.
Loose wiring terminal of input power	Tighten the terminal screws according to the torque described in the user manual.
The input cable of three-phase power is cut off.	Wire correctly. Replace the cut-off cable.
Unbalanced three-phase of input power	Check the power three-phase status.
Use Open Delta power system	Install reactors or use drives with higher power.

ID No.	Display on LCM Keypad	Fault Name	Fault Descriptions
16	oH1	IGBT overheating (oH1)	IGBT temperature exceeds the protection level. (Refer to Pr.06-15)
Action and Reset			
Action level	When Pr.06-15 is higher than the IGBT overheating protection level, oH1 error occurs instead of oH1 warning.		
Action time	IGBT temperature exceeds the protection level for more than 100 ms, oH1 error occurs.		
Fault treatment parameter	N/A		
Reset method	Manual reset		
Reset condition	Reset only when IGBT temperature is lower than oH1 error level minus (-) 10°C.		
Record	Yes		
Cause	Corrective Actions		
Check if the ambient temperature or temperature inside the control cabinet is too high, or if there is obstruction in the ventilation hole of the control cabinet.	<ol style="list-style-type: none"> 1. Check the ambient temperature. 2. Regularly inspect the ventilation hole of the control cabinet. 3. Change the installed place if there are heating objects, such as braking resistors, in the surroundings. 4. Install/ add cooling fan or air conditioner to lower the temperature inside the cabinet. 		
Check if there is any obstruction on the heat sink or if the fan is running.	Remove the obstruction or replace the cooling fan.		
Insufficient ventilation space	Increase ventilation space of the drive.		
Check if the drive matches the corresponding load.	<ol style="list-style-type: none"> 1. Reduce the load. 2. Reduce the carrier. 3. Replace the drive with a larger capacity model. 		
The drive has run 100% or more than 100% of the rated output for a long time.	Replace the drive with a larger capacity model		

ID No.	Display on LCM Keypad	Fault Name	Fault Descriptions
18	tH1o	IGBT temperature detection failure (tH1o)	IGBT hardware failure in temperature detection
Action and Reset			
Action level	NTC broken or wiring failure		
Action time	When the IGBT temperature is higher than the protection level, and detection time exceeds 100 ms, the tH1o protection activates.		
Fault treatment parameter	N/A		
Reset method	Manual reset		
Reset condition	Immediately reset		
Record	Yes		

Cause	Corrective Actions
Hardware failure	Wait for 10 minutes, and then cycle the power. Check if tH1o protection still exists. If yes, return to the factory for repair.

ID No.	Display on LCM Keypad	Fault Name	Fault Descriptions
21	oL	Overload (oL)	<p>The AC motor drive detects excessive drive output current.</p> <p>Overload capacity:</p> <ul style="list-style-type: none"> Normal duty: <ul style="list-style-type: none"> Sustains for one minute when the drive outputs 120% of the drive's rated output current. Sustains for three seconds when the drive outputs 150% of the drive's rated output current. Heavy duty: <ul style="list-style-type: none"> Sustains for one minute when the drive outputs 150% of the drive's rated output current. Sustains for three seconds when the drive outputs 200% of the drive's rated output current.
Action and Reset			
Action level		Based on overload curve and derating curve (Pr.06-55)	
Action time		When the load is higher than the protection level and exceeds allowable time, the oL protection activates.	
Fault treatment parameter		N/A	
Reset method		Manual reset	
Reset condition		Reset in 5 sec. after the fault is cleared.	
Record		Yes	
Cause			
Corrective Actions			
The load is too large.		Reduce the load.	
Accel./Decel. time and the working cycle are too short.		Increase the setting values for Pr.01-12-01-19 (accel. / decel. time).	
V/F voltage is too high.		Adjust the settings for Pr.01-01-01-08 (V/F curve), especially the setting value for the mid-point voltage (if the mid-point voltage is set too low, the load capacity decreases at low speed). Refer to the V/F curve selection of Pr.01-43.	
The capacity of the drive is too small.		Replace the drive with a larger capacity model.	
Overload during low-speed operation.		Reduce the load during low-speed operation. Increase the drive capacity. Decrease the carrier frequency of Pr.00-17.	
Torque compensation is too large.		Adjust the torque compensation (refer to Pr.07-26 torque compensation gain) until the output current reduces and the motor does not stall.	
Check if the setting for stall prevention is correct.		Set the stall prevention to the proper value.	
Output phase loss		Check the status of three-phase motor. Check if the cable is broken or the screws are loose.	
Improper parameter settings for the speed tracking function (including restart after momentary power loss and restart after fault)		Correct the parameter settings for speed tracking. 1. Start the speed tracking function. 2. Adjust the maximum current for Pr.07-09 speed tracking.	

ID No.	Display on LCM Keypad	Fault Name	Fault Descriptions
22	EoL1	Electronic thermal relay 1 protection (EoL1)	Electronic thermal relay 1 protection. The drive coasts to stop once it activates.
Action and Reset			
Action level		Start counting when output current > 150% of motor 1 rated current.	
Action time		Pr.06-14 (if the output current is larger than 105% of motor 1 rated current again within 60 sec., the counting time reduces and is less than Pr.06-14.)	
Fault treatment parameter		N/A	
Reset method		Manual reset	
Reset condition		Reset in 5 sec. after the fault is cleared.	
Record		Yes	

Cause	Corrective Actions
The load is too large.	Reduce the load.
Accel./Decel. time and the working cycle are too short.	Increase the setting values for Pr.01-12-01-19 (accel. / decel. time)
V/F voltage is too high.	Adjust the settings for Pr.01-01-01-08 (V/F curve), especially the setting value for the mid-point voltage (if the mid-point voltage is set too low, the load capacity decreases at low speed). Refer to the V/F curve selection of Pr.01-43.
Overload during low-speed operation. When using a general motor, even it operates below rated current, an overload may still occur during low-speed operation.	Decrease low-speed operation time. Replace the drive with a dedicated to VFD model. Increase the motor capacity.
When using VFD dedicated motors, Pr.06-13=0 (electronic thermal relay selection motor 1 = 0 inverter motor)	Pr.06-13=1 electronic thermal relay selection motor 1 = standard motor (motor with fan on the shaft).
Incorrect value of electronic thermal relay	Reset to the correct motor rated current.
The maximum motor frequency is set too low.	Reset to the correct motor rated frequency.
One drive to multiple motors	Set Pr.06-13=2 electronic thermal relay selection motor 1 = disable, and install thermal relay on each motor.
Check if the setting for stall prevention is correct.	Set the stall prevention to the proper value.
Torque compensation is too large.	Adjust the torque compensation (refer to Pr.07-26 torque compensation gain) until the current reduces and the motor does no stall.
Motor fan error	Check the status of the fan, or replace the fan.
Unbalanced three-phase impedance of the motor	Replace the motor.

ID No.	Display on LCM Keypad	Fault Name	Fault Descriptions
23	EoL2	Electronic thermal relay 2 protection (EoL2)	Electronic thermal relay 2 protection. The drive coasts to stop once it activates.
Action and Reset			
Action level		Start counting when output current > 150% of motor 2 rated current.	
Action time		Pr.06-28 (If the output current is larger than 105% of motor 2 rated current again within 60 sec., the counting time reduces and is less than Pr.06-28.)	
Fault treatment parameter		N/A	
Reset method		Manual reset	
Reset condition		Reset in 5 sec. after the fault is cleared.	
Record		Yes	
Cause	Corrective Actions		
The load is too large.	Reduce the load.		
Accel./Decel. time and the working cycle are too short.	Increase the setting values for Pr.01-12-01-19 (accel./decel. time)		
V/F voltage is too high.	Adjust the settings for Pr.01-01-01-08 (V/F curve), especially the setting value for the mid-point voltage (if the mid-point voltage is set too low, the load capacity decreases at low speed). Refer to the V/F curve selection setting of Pr.01-43.		
Overload during low-speed operation. When using a general motor, even it operates below rated current, an overload may still occur during low-speed operation.	Decrease low-speed operation time. Replace the drive with a dedicated to VFD model. Increase the motor capacity.		
When using VFD dedicated motors, Pr.06-27=0 (electronic thermal relay selection motor 2 = 0 inverter motor)	Pr.06-27=1 Electronic thermal relay selection motor 2 = standard motor (motor with fan on the shaft).		

Incorrect value of electronic thermal relay	Reset to the correct motor rated current.
The maximum motor frequency is set too low.	Reset to the correct motor rated frequency.
One drive to multiple motors	Set Pr.06-27=2 Electronic thermal relay selection motor 2 = disable, and install thermal relay on each motor.
Check if the setting for stall prevention is correct.	Set the stall prevention to the proper value.
Torque compensation is too large.	Adjust the torque compensation (refer to Pr.07-26 torque compensation gain) until the current reduces and the motor does no stall.
Motor fan error	Check the status of the fan, or replace the fan.
Unbalanced three-phase impedance of the motor	Replace the motor.

ID No.	Display on LCM Keypad	Fault Name	Fault Descriptions
24_1	oH3	Motor overheating (oH3) PTC	Motor overheating (PTC) (Pr.03-00=6 PTC). When PTC input > Pr.06-30, the fault treatment acts according to Pr.06-29.
Action and Reset			
Action level		PTC input value > Pr.06-30 setting (Default = 50%)	
Action time		Immediately act	
Fault treatment parameter		Pr.06-29 0: Warn and continue operation 1: Warn and ramp to stop 2: Warn and coast to stop 3: No warning	
Reset method		When Pr.06-29=0, oH3 is a "Warning". The "Warning" is automatically cleared. When Pr.06-29=1 or 2, oH3 is a "Fault". You must reset manually.	
Reset condition		Immediately reset	
Record		When Pr.06-29=1 or 2, oH3 is a fault, and the fault is recorded.	
Cause		Corrective Actions	
Motor shaft lock		Remove the shaft lock.	
The load is too large.		Reduce the load. Increase the motor capacity.	
Ambient temperature is too high.		Change the installed place If there are heating devices in the surroundings. Install/ add cooling fan or air conditioner to lower the ambient temperature.	
Motor cooling system error		Check the cooling system to make it work normally.	
Motor fan error		Replace the fan.	
Operate at low-speed too long.		Decrease low-speed operation time. Replace the motor with a dedicated to VFD model. Increase the motor capacity.	
Accel./Decel. time and working cycle are too short.		Increase the setting values for Pr.01-12-01-19 (accel./decel. time).	
V/F voltage is too high.		Adjust settings for Pr.01-01-01-08 (V/F curve), especially the setting value for the mid-point voltage (if the mid-point voltage is set too low, the load capacity decreases at low speed). Refer to the V/F curve selection of Pr.01-43.	
Check if the motor rated current matches that on the motor nameplate.		Reset to the correct motor rated current.	
Check if the PTC is properly set and wired.		Check the connection between PTC thermistor and the heat protection.	
Check if the setting for stall prevention is correct.		Set the stall prevention to the proper value.	
Unbalanced three-phase impedance of the motor		Replace the motor.	
Harmonics are too high.		Use remedies to reduce harmonics.	

ID No.	Display on LCM Keypad	Fault Name	Fault Descriptions
24_2	oH3	Motor overheating (oH3) PT100	Motor overheating (PT100) (Pr.03-00=11 PT100). When PT100 input > Pr.06-57 (default = 7 V), the fault treatment acts according to Pr.06-29.
Action and Reset			
Action level	PT100 input value > Pr.06-57 setting (default = 7 V)		
Action time	Immediately act		
Fault treatment parameter	Pr.06-29 0: Warn and continue operation 1: Warn and ramp to stop 2: Warn and coast to stop 3: No warning		
Reset method	When Pr.06-29=0 and the temperature < Pr.06-56, oH3 is automatically cleared. When Pr.06-29=1 or 2, oH3 is a "Fault". You must reset manually		
Reset condition	Immediately reset		
Record	When Pr.06-29=1 or 2, oH3 is a "Fault", and the fault is recorded.		
Cause	Corrective Actions		
Motor shaft lock	Remove the shaft lock.		
The load is too large.	Reduce the load. Increase the motor capacity.		
Ambient temperature is too high.	Change the installed place if there are heating devices in the surroundings. Install/ add cooling fan or air conditioner to lower the ambient temperature.		
Motor cooling system error	Check the cooling system to make it work normally.		
Motor fan error	Replace the fan		
Operate at low-speed too long.	Decrease low-speed operation time. Replace the motor with a dedicated to VFD model. Increase the motor capacity.		
Accel./Decel. time and working cycle are too short.	Increase the setting values for Pr.01-12-01-19 (accel./decel. time).		
V/F voltage is too high.	Adjust settings for Pr.01-01-01-08 (V/F curve), especially the setting value for the mid-point voltage (if the mid-point voltage is set too low, the load capacity decreases at low speed). Refer to the V/F curve selection of Pr.01-43.		
Check if the motor rated current matches that on the motor nameplate.	Reset to the correct motor rated current.		
Check if the PT100 is properly set and wired.	Check connection of PT100 thermistor.		
Check if the setting for stall prevention is correct.	Set the stall prevention to the proper value.		
Unbalanced three-phase impedance of the motor	Replace the motor.		
Harmonics are too high.	Use remedies to reduce harmonics.		

ID No.	Display on LCM Keypad	Fault Name	Fault Descriptions
26	ot1	Over-torque 1 (ot1)	When output current exceeds the over-torque detection level (Pr.06-07) and exceeds over-torque detection time (Pr.06-08), and when Pr.06-06 or Pr.06-09 is set to 2 or 4, the ot1 error displays.
Action and Reset			
Action level	Pr.06-07		
Action time	Pr.06-08		
Fault treatment parameter	Pr.06-06 0: No function 1: Continue operation after over-torque detection during constant speed operation 2: Stop after over-torque detection during constant speed operation 3: Continue operation after over-torque detection during RUN 4: Stop after over-torque detection during RUN		
Reset method	Auto	When Pr.06-06=1 or 3, ot1 is a "Warning". The warning is automatically cleared when the output current < (Pr.06-07 – 5%).	
	Manual	When Pr.06-06=2 or 4, ot1 is a "Fault". You must reset manually.	
Reset condition	Immediately reset		

Record	When Pr.06-06=2 or 4, ot1 is a "Fault", and the fault is recorded.
Cause	Corrective Actions
Incorrect parameter setting	Reset Pr.06-07 and 06-08.
Mechanical error (e.g. over-torque, mechanical lock)	Remove the causes of malfunction.
The load is too large.	Reduce the load. Replace the motor with a larger capacity model.
Accel./Decel. time and working cycle are too short.	Increase the setting values for Pr.01-12-01-19 (accel./decel. time).
V/F voltage is too high.	Adjust settings for Pr.01-01-01-08 (V/F curve), especially the setting value for the mid-point voltage (if the mid-point voltage is set too low, the load capacity decreases at low speed). Refer to the V/F curve selection of Pr.01-43.
The motor capacity is too small.	Replace the motor with a larger capacity model.
Overload during low-speed operation.	Decrease low-speed operation time. Increase the motor capacity.
Torque compensation is too large.	Adjust the torque compensation (refer to Pr.07-26 torque compensation gain) until the current reduces and the motor does no stall.
Improper parameter settings for speed tracking function (including restart after momentary power loss and restart after fault)	Correct the parameter settings for speed tracking. 1. Start the speed tracking function. 2. Adjust the maximum current for Pr.07-09 speed tracking.

ID No.	Display on LCM Keypad	Fault Name	Fault Descriptions
27	ot2	Over-torque 2 (ot2)	When output current exceeds the over-torque detection level (Pr.06-10) and exceeds over-torque detection time (Pr.06-11), and when Pr.06-09 is set to 2 or 4, the ot2 error displays.
Action and Reset			
Action level		Pr.06-10	
Action time		Pr.06-11	
Fault treatment parameter		Pr.06-09 0: No function 1: Continue operation after over-torque detection during constant speed operation 2: Stop after over-torque detection during constant speed operation 3: Continue operation after over-torque detection during RUN 4: Stop after over-torque detection during RUN	
Reset method		Auto	When Pr.06-09=1 or 3, ot2 is a "Warning". The warning is automatically cleared when the output current < (Pr.06-10 - 5%).
		Manual	When Pr.06-09=2 or 4, ot2 is a "Fault". You must reset manually.
Reset condition		Immediately reset	
Record		When Pr.06-09=2 or 4, ot2 is a "Fault", and the fault is recorded.	
Cause		Corrective Actions	
Incorrect parameter setting		Reset Pr.06-10 and Pr.06-11.	
Mechanical error (e.g. over-torque, mechanical lock)		Remove the causes of malfunction.	
The load is too large.		Reduce the load. Replace the motor with a larger capacity model.	
Accel./Decel. time and working cycle are too short.		Increase the setting values for Pr.01-12-01-19 (accel./decel. time).	
V/F voltage is too high.		Adjust the settings for Pr.01-35-01-42 (V/F curve), especially the setting value for the mid-point voltage (if the mid-point voltage is set too low, the load capacity decreases at low speed).	
The motor capacity is too small.		Replace the motor with a larger capacity model.	
Overload during low-speed operation		Decrease low-speed operation time. Increase the motor capacity.	
Torque compensation is too large.		Adjust the torque compensation (refer to Pr.07-26 torque compensation gain) until the current reduces and the motor does no stall.	
Improper parameter settings for speed tracking function (including restart at momentary power loss and restart after fault)		Correct the parameter settings for speed tracking. 1. Start the speed tracking function. 2. Adjust the maximum current for Pr.07-09 speed tracking.	

ID No.	Display on LCM Keypad	Fault Name	Fault Descriptions
28	uL	Under current (uC)	Low current detection
Action and Reset			
Action level		Pr.06-71	
Action time		Pr.06-72	
Fault treatment parameter		Pr.06-73 0: No function 1: warn and coast to stop 2: warn and ramp to stop by the 2 nd deceleration time 3: warn and continue operation	
Reset method		Auto	When Pr.06-73=3, uC is a "Warning". The warning is automatically cleared when the output current > (Pr.06-71 + 0.1 A).
		Manual	When Pr.06-73=1 or 2, uC is a "Fault". You must reset manually.
Reset condition		Immediately reset	
Record		When Pr.06-73=1 or 2, uC is a "Fault", and the fault is recorded.	
Cause		Corrective Actions	
Motor cable disconnection		Troubleshoot the connection between the motor and the load.	
Improper setting of low-current protection		Reset Pr.06-71, Pr.06-72 and Pr.06-73 to proper settings.	
The load is too low.		Check the load status. Check if the motor capacity matches the load.	

ID No.	Display on LCM Keypad	Fault Name	Fault Descriptions
31	cF2	EEPROM read error (cF2)	Internal EEPROM cannot be read.
Action and Reset			
Action level		Firmware internal detection	
Action time		cF2 acts immediately when the drive detects the fault.	
Fault treatment parameter		N/A	
Reset method		Manual reset	
Reset condition		Immediately reset	
Record		Yes	
Cause		Corrective Actions	
Internal EEPROM cannot be read.		Press RESET key. If cF2 error still displays on the keypad, return to the factory for repair. Reset the parameter to the default setting. If cF2 error still displays on the keypad, return to the factory for repair. Cycle the power. If cF2 error still exists, return to the factory for repair.	

ID No.	Display on LCM Keypad	Fault Name	Fault Descriptions
33	cd1	U-phase error (cd1)	U-phase current detection error when power is ON.
Action and Reset			
Action level		Hardware detection	
Action time		cd1 acts immediately when the drive detects the fault.	
Fault treatment parameter		N/A	
Reset method		Power-off	
Reset condition		N/A	
Record		Yes	
Cause		Corrective Actions	
Hardware failure		Cycle the power. If the fault code still displays on the keypad, return to the factory for repair.	

ID No.	Display on LCM Keypad	Fault Name	Fault Descriptions
34	cd2	V-phase error (cd2)	V-phase current detection error when power is ON.
Action and Reset			
Action level		Hardware detection	
Action time		cd2 acts immediately when the drive detects the fault.	

Fault treatment parameter	N/A
Reset method	Power-off
Reset condition	N/A
Record	Yes
Cause	Corrective Actions
Hardware failure	Cycle the power. If the fault code still displays on the keypad, return to the factory for repair.

ID No.	Display on LCM Keypad	Fault Name	Fault Descriptions
35	cd3	W-phase error (cd3)	W-phase current detection error when power is ON.
Action and Reset			
Action level		Hardware detection	
Action time		cd3 acts immediately when the drive detects the fault.	
Fault treatment parameter		N/A	
Reset method		Power-off	
Reset condition		N/A	
Record		Yes	
Cause		Corrective Actions	
Hardware failure		Cycle the power. If the fault code still displays on the keypad, return to the factory for repair.	

ID No.	Display on LCM Keypad	Fault Name	Fault Descriptions
36	Hd0	cc Hardware failure (Hd0)	cc (current clamp) hardware protection error when power is ON.
Action and Reset			
Action level		Hardware detection	
Action time		Hd0 acts immediately when the drive detects the fault.	
Fault treatment parameter		N/A	
Reset method		Power-off	
Reset condition		N/A	
Record		Yes	
Cause		Corrective Actions	
Hardware failure		Cycle the power. If the fault code still displays on the keypad, return to the factory for repair.	

ID No.	Display on LCM Keypad	Fault Name	Fault Descriptions
37	Hd1	Oc Hardware failure (Hd1)	oc hardware protection error when power is ON.
Action and Reset			
Action level		Hardware detection	
Action time		Hd1 acts immediately when the drive detects the fault.	
Fault treatment parameter		N/A	
Reset method		Power-off	
Reset condition		N/A	
Record		Yes	
Cause		Corrective Actions	
Hardware failure		Cycle the power. If the fault code still displays on the keypad, return to the factory for repair.	

ID No.	Display on LCM Keypad	Fault Name	Fault Descriptions
40	AUE	Auto-tuning error (AUE)	Motor auto-tuning error
Action and Reset			
Action level		Hardware detection	
Action time		Immediately act	
Fault treatment parameter		N/A	
Reset method		Manual reset	

Reset condition	Immediately reset
Record	Yes
Cause	Corrective Actions
Press STOP key during auto-tuning.	Re-execute auto-tuning.
Incorrect motor capacity (too large or too small) and parameter setting	Check motor capacity and related parameters. Set the correct parameters, that is Pr.01-01-01-02. Set Pr.01-00 larger than motor rated frequency.
Incorrect motor wiring	Check the wiring.
Motor shaft lock	Remove the cause of motor shaft lock.
The electromagnetic contactor is ON at output side (U/V/W) of the drive	Make sure the electromagnetic valve is OFF.
The load is too large.	Reduce the load. Replace the motor with a larger capacity model.
Accel./Decel. time is too short.	Increase the setting values for Pr.01-12-01-19 (Accel./Decel. time).

ID No.	Display on LCM Keypad	Fault Name	Fault Descriptions
41	AFE	PID loss ACI (AFE)	PID feedback loss (analog feedback signal is only valid when the PID function is enabled.)
Action and Reset			
Action level		When the analog input < 4 mA (only detects 4–20 mA analog input)	
Action time		Pr.08-08	
Fault treatment parameter		Pr.08-09 0: warn and continue operation 1: warn and ramp to stop 2: warn and coast to stop 3: warn and operate at last frequency	
Reset method		Auto	When Pr.08-09=3 or 4, AFE is a “Warning”. When the feedback signal is > 4 mA, the “Warning” is automatically cleared.
		Manual	When Pr.08-09=1 or 2, AFE is a “Fault”. You must rest manually.
Reset condition		Immediately reset	
Record		When Pr.08-09=1 or 2, AFE is a “Fault”, and the fault is recorded; when Pr.08-09=3 or 4, AFE is a “Warning”, and the warning is not recorded.	
Cause		Corrective Actions	
PID feedback cable is loose or cut off.		Tighten the terminal. Replace the cable with a new one.	
Feedback device failure		Replace the device with a new one.	
Hardware failure		Check all the wiring. If the AFE fault still displays on the keypad, return to the factory for repair.	

ID No.	Display on LCM Keypad	Fault Name	Fault Descriptions
48	ACE	ACI loss (ACE)	Analog input loss (including all the 4–20 mA analog signal)
Action and Reset			
Action level		When the analog input is < 4 mA (only detects 4–20 mA analog input)	
Action time		Immediately act	
Fault treatment parameter		Pr.03-19 0: Disable 1: Continue operation at the last frequency (warning, ANL displays on the keypad) 2: Decelerate to 0 Hz (warning, ANL displays on the keypad) 3: Stop immediately and display “ACE”	
Reset method		Auto	When Pr.03-19=1 or 2, ACE is a “Warning”. When analog input signal is > 4 mA, the “Warning” is automatically cleared.
		Manual	When Pr.03-19=3, ACE is a “Fault”. You must reset manually.
Reset condition		Immediately reset	
Record		When Pr.03-19=3, ACE is a “Fault”, and the fault is recorded.	
Cause		Corrective Actions	
ACI cable is loose or cut off.		Tighten the terminal. Replace the cable with a new one.	

External device failure	Replace the device with a new one.
Hardware failure	Check all the wiring. If the ACE fault still displays on the keypad, return to the factory for repair.

ID No.	Display on LCM Keypad	Fault Name	Fault Descriptions
49	EF	External fault (EF)	External fault. When the drive decelerates based on the setting of Pr.07-20, the EF fault displays on the keypad
Action and Reset			
	Action level	MI=EF and the MI terminal is ON.	
	Action time	Immediately act	
	Fault treatment parameter	Pr.07-20 0: Coast to stop 1: Stop by 1 st deceleration time 2: Stop by 2 nd deceleration time 3: Stop by 3 rd deceleration time 4: Stop by 4 th deceleration time 5: System deceleration 6: Automatic deceleration	
	Reset method	Manual reset	
	Reset condition	Manual reset only after the external fault is cleared (terminal status is recovered).	
	Record	Yes	
	Cause	Corrective Actions	
	External fault	Press RESET key after the fault is cleared.	

ID No.	Display on LCM Keypad	Fault Name	Fault Descriptions
50	EF1	Emergency stop (EF1)	When the contact of MI=EF1 is ON, the output stops immediately and displays EF1 on the keypad. The motor is in free running.
Action and Reset			
	Action level	MI=EF1 and the MI terminal is ON.	
	Action time	Immediately act	
	Fault treatment parameter	N/A	
	Reset method	Manual reset	
	Reset condition	Manual reset only after the external fault is cleared (terminal status is recovered).	
	Record	Yes	
	Cause	Corrective Actions	
	MI=EF1 activates	Verify if the system is back to normal condition, and then press RESET key to return to the default.	

ID No.	Display on LCM Keypad	Fault Name	Fault Descriptions
51	bb	External base block (bb)	When the contact of MI=bb is ON, the output stops immediately and displays bb on the keypad. The motor is in free running.
Action and Reset			
	Action level	MI=bb and the MI terminal is ON.	
	Action time	Immediately act	
	Fault treatment parameter	N/A	
	Reset method	The display "bb" is automatically cleared after the fault is cleared.	
	Reset condition	N/A	
	Record	No	
	Cause	Corrective Actions	
	MI=bb activates	Verify if the system is back to normal condition, and then press RESET key to return to the default.	

ID No.	Display on LCM Keypad	Fault Name	Fault Descriptions
52	Pcod	Password is locked (Pcod)	Entering the wrong password three consecutive times
Action and Reset			
Action level		Entering the wrong password three consecutive times	
Action time		Immediately act	
Fault treatment parameter		N/A	
Reset method		Manual reset	
Reset condition		Power-off	
Record		Yes	
Cause		Corrective Actions	
Incorrect password input through Pr.00-07		<ol style="list-style-type: none"> 1. Input the correct password after rebooting the motor drive. 2. If you forget the password, enter 9999. 3. Press ENTER, and then enter 9999 again. 4. You must finish pressing ENTER within 10 seconds. If not, you must repeat the entering. After you successfully unlock the password, the parameter settings return to the default. 	

ID No.	Display on LCM Keypad	Fault Name	Fault Descriptions
54	CE1	Illegal command (CE1)	Communication command is illegal
Action and Reset			
Action level		When the function code is not 03, 06, 10, or 63.	
Action time		Immediately act	
Fault treatment parameter		N/A	
Reset method		Manual reset	
Reset condition		Immediately reset	
Record		No	
Cause		Corrective Actions	
Incorrect communication command from the upper unit		Check if the communication command is correct.	
Malfunction caused by interference		Verify the wiring and grounding of the communication circuit. It is recommended to separate the communication circuit from the main circuit, or wire in 90 degree for effective anti-interference performance.	
Different communication setting from the upper unit		Check if the setting for Pr.09-02 is the same as the setting for the upper unit.	
Disconnection or bad connection of the cable		Check the cable and replace it if necessary.	

ID No.	Display on LCM Keypad	Fault Name	Fault Descriptions
55	CE2	Illegal data address (CE2)	Data address is illegal.
Action and Reset			
Action level		When the data address is correct.	
Action time		Immediately act	
Fault treatment parameter		N/A	
Reset method		Manual reset	
Reset condition		Immediately reset	
Record		No	
Cause		Corrective Actions	
Incorrect communication command from the upper unit		Check if the communication command is correct.	
Malfunction caused by interference		Verify the wiring and grounding of the communication circuit. It is recommended to separate the communication circuit from the main circuit, or wire in 90 degree for effective anti-interference performance.	
Different communication setting from the upper unit		Check if the setting for Pr.09-02 is the same as the setting for the upper unit.	
Disconnection or bad connection of the cable		Check the cable and replace it if necessary.	

ID No.	Display on LCM Keypad	Fault Name	Fault Descriptions
56	CE3	Illegal data value (CE3)	Data value is illegal.
Action and Reset			
	Action level	When the data length is too long.	
	Action time	Immediately act	
	Fault treatment parameter	N/A	
	Reset method	Manual reset	
	Reset condition	Immediately reset	
	Record	No	
	Cause	Corrective Actions	
	Incorrect communication command from the upper unit	Check if the communication command is correct.	
	Malfunction caused by interference	Verify the wiring and grounding of the communication circuit. It is recommended to separate the communication circuit from the main circuit, or wire in 90 degree for effective anti-interference performance.	
	Different communication setting from the upper unit	Check if the setting for Pr.09-02 is the same as the setting for the upper unit.	
	Disconnection or bad connection of the cable	Check the cable and replace it if necessary.	

ID No.	Display on LCM Keypad	Fault Name	Fault Descriptions
57	CE4	Data is written to read-only address (CE4)	Data is written to read-only address.
Action and Reset			
	Action level	When the data is written to read-only address.	
	Action time	Immediately act	
	Fault treatment parameter	N/A	
	Reset method	Manual reset	
	Reset condition	Immediately reset	
	Record	No	
	Cause	Corrective Actions	
	Incorrect communication command from the upper unit	Check if the communication command is correct.	
	Malfunction caused by interference	Verify the wiring and grounding of the communication circuit. It is recommended to separate the communication circuit from the main circuit, or wire in 90 degree for effective anti-interference performance.	
	Different communication setting from the upper unit	Check if the setting for Pr.09-02 is the same as the setting for the upper unit.	
	Disconnection or bad connection of the cable	Check the cable and replace it if necessary.	

ID No.	Display on LCM Keypad	Fault Name	Fault Descriptions
58	CE10	Modbus transmission time-out (CE10)	Modbus transmission time-out occurs.
Action and Reset			
	Action level	When the communication time exceeds the detection time for Pr.09-03 time-out.	
	Action time	Pr.09-03	
	Fault treatment parameter	Pr.09-02 0: Warn and continue operation 1: Warn and ramp to stop 2: Warn and coast to stop 3: No warning and continue operation	
	Reset method	Manual reset	
	Reset condition	Immediately reset	
	Record	Yes	

Cause	Corrective Actions
The upper unit does not transmit the communication command within Pr.09-03 setting time.	Check if the upper unit transmits the communication command within the setting time for Pr.09-03.
Malfunction caused by interference	Verify the wiring and grounding of the communication circuit. It is recommended to separate the communication circuit from the main circuit, or wire in 90 degree for effective anti-interference performance.
Different communication setting from the upper unit	Check if the setting for Pr.09-02 is the same as the setting for the upper unit.
Disconnection or bad connection of the cable	Check the cable and replace it if necessary.

ID No.	Display on LCM Keypad	Fault Name	Fault Descriptions
61	ydc	Y-connection / Δ-connection switch error (ydc)	An error occurs when Y-Δ switches.
Action and Reset			
Action level	1. ydc occurs when the confirmation signals of Y-connection and Δ-connection are conducted at the same time. 2. If any of confirmation signals is not conducted within Pr.05-25 setting time, ydc occurs.		
Action time	Pr.05-25		
Fault treatment parameter	N/A		
Reset method	Manual reset		
Reset condition	Can be reset only when the confirmation signal of Y-connection is conducted if it is Y-connection, or when the confirmation signal of Δ-connection is conducted if it is Δ-connection.		
Record	Yes		
Cause		Corrective Actions	
The electromagnetic valve operates incorrectly during Y-Δ switch.		Check if the electromagnetic valve works normally. If not, replace it.	
Incorrect parameter setting		Check if related parameters are all set up and set correctly.	
The wiring of Y-Δ switch function is incorrect.		Check the wiring.	

ID No.	Display on LCM Keypad	Fault Name	Fault Descriptions
63	oSL	Over-slip (oSL)	The slip is abnormal. By using the maximum slip (Pr.10-29) as the base, when the drive outputs at constant speed, and the F>H or F<H exceeds Pr.07-29 level and Pr.07-30 setting time, oSL occurs. oSL occurs only when using a general induction motor.
Action and Reset			
Action level	Pr.07-29 (100% of Pr.07-29 = Pr.10-29 Top limit of frequency deviation)		
Action time	Pr.07-30		
Fault treatment parameter	Pr.07-31 0: Warn and continue operation 1: Warn and ramp to stop 2: Warn and coast to stop 3: No warning		
Reset method	Auto	When Pr.07-31 = 0, oSL is a "Warning" When the drive outputs at constant speed, and the F>H or F<H no longer exceeds the Pr.07-29 level, the oSL warning is automatically cleared.	
	Manual	When Pr.07-31 = 1 or 2, oSL is a "Fault". You must reset manually.	
Reset condition	Immediately reset		
Record	When Pr.07-31 = 1 or 2, oSL is a "Fault", and the fault is recorded.		
Cause		Corrective Actions	
Check if the motor setting is correct.		Check the motor parameter.	

The load is too large.	Decrease the load.
Check if the settings for Pr.07-29, Pr.07-30 and Pr.10-29 are properly set.	Check the parameter settings for oSL protection.

ID No.	Display on LCM Keypad	Fault Name	Fault Descriptions
72	STL1	S1 internal loop detection error (STL1)	S1-DCM internal loop detection error
Action and Reset			
Action level		Hardware detection	
Action time		Immediately act	
Fault treatment parameter		N/A	
Reset method		Hardware failure, and cannot reset. Cycle the power.	
Reset condition		N/A	
Record		Yes	
Cause		Corrective Actions	
STO jumper cap is not installed or is off.		Install the jumper cap.	
External STO card S1 and +24 V short circuit line are not connected.		Check the wiring of the S1 and +24 V terminal.	
External STO card is installed incorrectly or pin fractures.		Check if STO card is correctly installed.	
Insufficient external input voltage		Check that the input voltage maintains at least 11 V.	
False trigger		Reset the emergency switch (ON: activated) and cycle the power.	
Hardware failure		After you make sure all the wiring is correct, if STL1 fault still exists after cycling the power, please contact Delta.	

ID No.	Display on LCM Keypad	Fault Name	Fault Descriptions
76	STO	STO (STO)	Safe Torque Off function activates.
Action and Reset			
Action level		Hardware detection	
Action time		Immediately act	
Fault treatment parameter		N/A	
Reset method		Auto	When Pr.06-44 = 1 and after STO error is cleared, it automatically resets.
		Manual	When Pr.06-44 = 0 and after STO error is cleared, reset it manually.
Reset condition		Reset only after STO error is cleared.	
Record		Yes	
Cause		Corrective Actions	
The switch action of S1/+24 V and S2/+24 V		Check the wiring of the S1 and S2 terminals.	
External STO card is installed incorrectly or pin fractures.		Check if STO card is correctly installed.	
False trigger		Reset the emergency switch (ON: activated) and cycle the power.	
Insufficient external input voltage		Check that the input voltage maintains at least 11 V.	
Hardware failure		After you make sure all the wiring is correct, if STO fault still exists after cycling the power, please contact Delta.	

ID No.	Display on LCM Keypad	Fault Name	Fault Descriptions
77	STL2	S2 internal loop detection error (STL2)	S2-DCM internal loop detection error
Action and Reset			
Action level		Hardware detection	
Action time		Immediately act	
Fault treatment parameter		N/A	
Reset method		Hardware failure, and cannot reset. Cycle the power.	
Reset condition		N/A	

Record	Yes
Cause	Corrective Actions
STO jumper cap is not installed or is off.	Install the jumper cap.
External STO card S1 and +24 V short circuit line are not connected.	Check the wiring of the S1 and +24 V terminals.
External STO card is installed incorrectly or pin fractures.	Check if STO card is correctly installed.
Insufficient external input voltage	Check that the input voltage maintains at least 11 V.
False trigger	Reset the emergency switch (ON: activated) and cycle the power.
Hardware failure	After you make sure all the wiring is correct, if STL2 fault still exists after cycling the power, please contact Delta.

ID No.	Display on LCM Keypad	Fault Name	Fault Descriptions
78	STL3	S3 internal loop detection error (STL3)	S1-DCM & S2-DCM internal loop detection error
Action and Reset			
Action level		Hardware detection	
Action time		Immediately act	
Fault treatment parameter		N/A	
Reset method		Hardware failure, and cannot reset. Cycle the power.	
Reset condition		N/A	
Record		Yes	
Cause		Corrective Actions	
STO jumper cap is not installed or is off.		Install the jumper cap.	
Incorrect wiring of STO card		Check all the wiring of STO card.	
External STO card is installed incorrectly or pin fractures.		Check if STO card is correctly installed.	
False trigger		Reset the emergency switch (ON: activated) and cycle the power.	
Hardware failure		After you make sure all the wiring is correct, if STL3 fault still exists after cycling the power, please contact Delta.	

ID No.	Display on LCM Keypad	Fault Name	Fault Descriptions
79	Aoc	U-phase short circuit (Aoc)	U-phase short circuit detected when output wiring detection is performed before the drive runs.
Action and Reset			
Action level		240% of the rated current	
Action time		Immediately act	
Fault treatment parameter		N/A	
Reset method		Manual reset	
Reset condition		Reset in 5 sec. after the fault is cleared.	
Record		Yes	
Cause		Corrective Actions	
Incorrect motor wiring		Check if the motor's internal wiring and the UVW wiring of the drive output terminal are correct.	
Short-circuit at motor output due to poor insulation wiring.		Without considering the short circuits, check the motor cable or replace the cable before turning on the power.	
Check for possible burnout or aging insulation of the motor.		Check the motor insulation value with megger. Replace the motor if the insulation is poor.	
Malfunction caused by interference		Verify the wiring of the control circuit and wiring/grounding of the main circuit to prevent interference.	
The length of motor cable is too long.		Increase the AC motor drive's capacity. Install AC reactor(s) on the output side (U/V/W).	
Hardware failure		The Aoc occurs due to short circuit or ground fault at the output side of the drive. Check for possible short circuits between terminals with the electric meter: B1 corresponds to U, V, W; DC- corresponds to U, V, W; ⊕ corresponds to U, V, W. If short circuits occur, return to the factory for repair.	

ID No.	Display on LCM Keypad	Fault Name	Fault Descriptions
80	boc	V-phase short circuit (Boc)	V-phase short circuit detected when output wiring detection is performed before the drive runs.
Action and Reset			
Action level		240% of the rated current	
Action time		Immediately act	
Fault treatment parameter		N/A	
Reset method		Manual reset	
Reset condition		Reset in 5 sec. after the fault is cleared.	
Record		Yes	
Cause		Corrective Actions	
Incorrect motor wiring		Check if the motor's internal wiring and the UVW wiring of the drive output terminal are correct.	
Short-circuit at motor output due to poor insulation wiring.		Without considering the short circuits, check the motor cable or replace the cable before turning on the power.	
Check for possible burnout or aging insulation of the motor.		Check the motor insulation value with megger. Replace the motor if the insulation is poor.	
Malfunction caused by interference		Verify the wiring of the control circuit and wiring/grounding of the main circuit to prevent interference.	
The length of motor cable is too long.		Increase the AC motor drive's capacity. Install AC reactor(s) on the output side (U/V/W).	
Hardware failure		The Boc occurs due to short circuit or ground fault at the output side of the drive. Check for possible short circuits between terminals with the electric meter: B1 corresponds to U, V, W; DC- corresponds to U, V, W; ⊕ corresponds to U, V, W. If short circuits occur, return to the factory for repair.	

ID No.	Display on LCM Keypad	Fault Name	Fault Descriptions
81	coc	W-phase short circuit (Coc)	W-phase short circuit detected when output wiring detection is performed before the drive runs.
Action and Reset			
Action level		240% of the rated current	
Action time		Immediately act	
Fault treatment parameter		N/A	
Reset method		Manual reset	
Reset condition		Reset in 5 sec. after the fault is cleared.	
Record		Yes	
Cause		Corrective Actions	
Incorrect motor wiring		Check if the motor's internal wiring and the UVW wiring of the drive output terminal are correct.	
Short-circuit at motor output due to poor insulation wiring.		Without considering the short circuits, check the motor cable or replace the cable before turning on the power.	
Check for possible burnout or aging insulation of the motor.		Check the motor insulation value with megger. Replace the motor if the insulation is poor.	
Malfunction caused by interference		Verify the wiring of the control circuit and wiring/grounding of the main circuit to prevent interference.	
The length of motor cable is too long.		Increase the AC motor drive's capacity. Install AC reactor(s) on the output side (U/V/W).	
Hardware failure		The Coc occurs due to short circuit or ground fault at the output side of the drive. Check for possible short circuits between terminals with the electric meter: B1 corresponds to U, V, W; DC- corresponds to U, V, W; ⊕ corresponds to U, V, W. If short circuits occur, return to the factory for repair.	

ID No.	Display on LCM Keypad	Fault Name	Fault Descriptions
82	oPL1	Output phase loss U phase (OPL1)	U phase output phase loss
Action and Reset			
Action level		Pr.06-47	
Action time		Pr.06-46 Pr.06-48: Use the setting value of Pr.06-48 first. If DC braking function activates, use that of Pr.06-46.	

Fault treatment parameter	Pr.06-45 0: Warn and continue operation 1: Warn and ramp to stop 2: Warn and coast to stop 3: No warning
Reset method	Manual reset
Reset condition	Immediately reset
Record	When Pr.06-45=1 or 2, OPL1 is a "Fault", and the fault is recorded.
Cause	Corrective Actions
Unbalanced three-phase impedance of the motor	Replace the motor.
Check if the wiring is incorrect.	Check the cable and replace it if necessary. Check the motor's internal wiring. If the fault still exists, replace the motor.
Check if the motor is a single-phase motor.	Choose a three-phase motor.
Check if the current sensor is broken.	Check if the control board cable is loose. If yes, reconnect the cable and run the drive to test. If the fault still exists, return to the factory for repair. Check if the three-phase current is balanced with a current clamp meter. If the current is balanced and the OPL1 fault still exists, return to the factory for repair.
Check if the drive capacity is larger than the motor capacity.	Choose the drive that matches the motor capacity.

ID No.	Display on LCM Keypad	Fault Name	Fault Descriptions
83	OPL2	Output phase loss V phase (OPL2)	V phase output phase loss
Action and Reset			
Action level		Pr.06-47	
Action time		Pr.06-46 Pr.06-48: Use the setting value of Pr.06-48 first. If DC braking function activates, use that of Pr.06-46.	
Fault treatment parameter		Pr.06-45 0: Warn and continue operation 1: Warn and ramp to stop 2: Warn and coast to stop 3: No warning	
Reset method		Manual reset	
Reset condition		Immediately reset	
Record		When Pr.06-45=1 or 2, OPL2 is a "Fault", and the fault is recorded.	
Cause		Corrective Actions	
Unbalanced three-phase impedance of the motor		Replace the motor.	
Check if the wiring is incorrect.		Check the cable and replace it if necessary. Check the motor's internal wiring. If the fault still exists, replace the motor.	
Check if the motor is a single-phase motor.		Choose a three-phase motor.	
Check if the current sensor is broken.		Check if the control board cable is loose. If yes, reconnect the cable and run the drive to test. If the fault still exists, return to the factory for repair. Check if the three-phase current is balanced with a current clamp meter. If the current is balanced and the OPL2 fault still exists, return to the factory for repair.	
Check if the drive capacity is larger than the motor capacity.		Choose the drive that matches the motor capacity.	

ID No.	Display on LCM Keypad	Fault Name	Fault Descriptions
84	OPL3	Output phase loss W phase (OPL3)	W phase output phase loss
Action and Reset			
Action level		Pr.06-47	
Action time		Pr.06-46 Pr.06-48: Use the setting value of Pr.06-48 first. If DC braking function activates, use that of Pr.06-46..	

Fault treatment parameter	Pr.06-45 0: Warn and continue operation 1: Warn and ramp to stop 2: Warn and coast to stop 3: No warning
Reset method	Manual reset
Reset condition	Immediately reset
Record	When Pr.06-45=1 or 2, OPL3 is a "Fault", and the fault is recorded.
Cause	Corrective Actions
Unbalanced three-phase impedance of the motor	Replace the motor.
Check if the wiring is incorrect.	Check the cable and replace it if necessary. Check the motor's internal wiring. If the fault still exists, replace the motor.
Check if the motor is a single-phase motor.	Choose a three-phase motor.
Check if the current sensor is broken.	Check if the control board cable is loose. If yes, reconnect the cable and run the drive to test. If the fault still exists, return to the factory for repair. Check if the three-phase current is balanced with a current clamp meter. If the current is balanced and the OPL3 fault still exists, return to the factory for repair.
Check if the drive capacity is larger than the motor capacity.	Choose the drive that matches the motor capacity.

ID No.	Display on LCM Keypad	Fault Name	Fault Descriptions
87	oL3	Overload protection at low frequency (oL3)	Low frequency and high current protection
Action and Reset			
	Action level	Software detection	
	Action time	Immediately act	
	Fault treatment parameter	N/A	
	Reset method	Manual reset	
	Reset condition	Immediately reset	
	Record	Yes	
	Cause	Corrective Actions	
	The drive operates in the low frequency range (High HP: below 15 Hz; Low HP: below 5 Hz) and IGBT temperature (High HP: 20°C; Low HP: 50°C).	<ol style="list-style-type: none"> 1. Improve heat dissipation 2. Raise power 3. Change the control mode 4. Reset or reduce the carrier frequency 	

ID No.	Display on LCM Keypad	Fault Name	Fault Descriptions
89	roPd	Rotor position detection error (RoPd)	Rotor position detection error protection
Action and Reset			
	Action level	Reset the software.	
	Action time	Immediately act	
	Fault treatment parameter	N/A	
	Reset method	Manual reset	
	Reset condition	Immediately reset	
	Record	Yes	
	Cause	Corrective Actions	
	Check if the motor cable is abnormal or broken.	Check or replace the cable.	
	Motor coil error	Replace the motor.	
	Hardware failure	IGBT broken. Return to the factory for repair.	
	Drive's current feedback line error	Cycle the power. If RoPd still occurs during operation, return to the factory for repair.	

ID No.	Display on LCM Keypad	Fault Name	Fault Descriptions
140	Hd6	GFF detected when power is on (Hd6)	The ground current short circuit detected when power is on.
Action and Reset			
Action level		Reset the software.	
Action time		Immediately act	
Fault treatment parameter		N/A	
Reset method		Manual reset	
Reset condition		Immediately reset	
Record		Yes	
Cause		Corrective Actions	
The length of motor cable is too long.		Use a shorter cable or install an output reactor.	
Check if the motor cable is abnormal or broken.		Check or replace the cable.	
Hardware failure		IGBT broken. Return to the factory for repair.	
Drive's current feedback line error		Cycle the power. If Hd6 still occurs during operation, return to the factory for repair.	

ID No.	Display on LCM Keypad	Fault Name	Fault Descriptions
141	b4GFF	GFF occurs before running (b4GFF)	The ground short circuit detected when output wiring detection is performed before the drive runs.
Action and Reset			
Action level		240% of the rated current	
Action time		Immediately act	
Fault treatment parameter		N/A	
Reset method		Manual reset	
Reset condition		Reset in 5 sec. after the fault is cleared.	
Record		Yes	
Cause		Corrective Actions	
Incorrect motor wiring		Check if the motor's internal wiring and the UVW wiring of the drive output terminal are correct.	
Short-circuit at motor output due to poor insulation wiring.		Without considering the short circuits, check the motor cable or replace the cable before turning on the power.	
Check for possible burnout or aging insulation of the motor.		Check the motor insulation value with megger. Replace the motor if the insulation is poor.	

ID No.	Display on LCM Keypad	Fault Name	Fault Descriptions
142	AUE1	Auto-tune error 1 (AUE1)	No feedback current error when motor parameter automatically detects.
Action and Reset			
Action level		Software detection	
Action time		Immediately act	
Fault treatment parameter		N/A	
Reset method		Manual reset	
Reset condition		Immediately reset	
Record		Yes	
Cause		Corrective Actions	
Motor is not wired.		Wire the motor correctly.	
The electromagnetic contactor is used as an open state on the output side of the drive (U/V/W).		Verify that the electromagnetic valve is closed.	

ID No.	Display on LCM Keypad	Fault Name	Fault Descriptions
143	AUE2	Auto-tune error 2 (AUE2)	Motor phase loss error when motor parameter automatically detects.
Action and Reset			
Action level		Software detection	
Action time		Immediately act	

Fault treatment parameter	N/A
Reset method	Manual reset
Reset condition	Immediately reset
Record	Yes
Cause	Corrective Actions
Incorrect motor wiring	Wire the motor correctly.
Motor error	Check if the motor works normally.
The electromagnetic contactor is used as an open state on the output side of the drive (U/V/W).	Verify that the three-phases of the electromagnetic valve are all closed.
Motor U/V/W wire error	Check if the wires are broken.

ID No.	Display on LCM Keypad	Fault Name	Fault Descriptions
144	AUE3	Auto-tune error 3 (AUE3)	No load current I_0 measurement error when motor parameter automatically detects.
Action and Reset			
Action level		Software detection	
Action time		Immediately act	
Fault treatment parameter		N/A	
Reset method		Manual reset	
Reset condition		Immediately reset	
Record		Yes	
Cause		Corrective Actions	
Incorrect settings for the motor parameter (rated current)		Check the settings for Pr.05-01 / Pr.05-13 / Pr.05-34.	
Motor error		Check if the motor works normally.	

[This page intentionally left blank]

Chapter 15 Safe Torque Off Function

15-1 Basic Function Description

15-2 Safe Torque Off Terminal Function Description

15-3 Wiring Diagram

15-4 Failure Rate of the Drive Safety Function

15-5 Reset the Parameter Settings

15-6 Timing Diagram Description

15-7 Error Code and Troubleshooting Instructions

15-8 Test and Fault Confirmation

15-1 Basic Function Description

The ME300 series provide a Safe Torque Off (STO) function. The ME300 series use dual-channel S1 and S2 signal inputs to turn off IGBT switching, further preventing the generation of motor torque in order to achieve a safe stop. Refer to Figure 1 for the Safe Torque Off function circuit diagram.

The ME300 Safe Torque Off function meets the following international standards:

ISO 13849-1: 2015 Category 3 PL d

IEC 61508 SIL2

EN 62061 SIL CL 2

EN 60204-1 Category 0

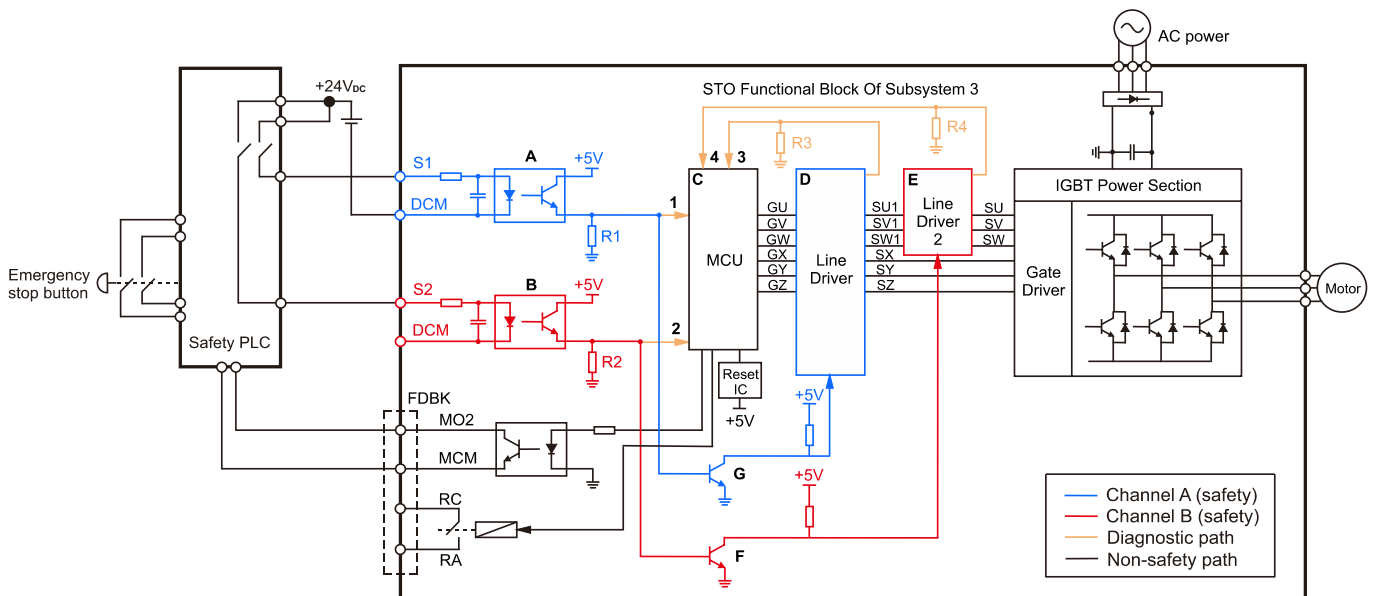

Figure 1: The circuit diagram for the Safe Torque Off function

15-2 Safe Torque Off Terminal Function Description

Table 1 describes the STO (Safe Torque Off) related terminal functions.

Terminals	Terminal Function	Description
+24 V	When the STO function is not used, you can disable the STO function by shorting S1 and S2 with +24 V.	Output voltage range: +24 V \pm 10% Output voltage capacity: 100 mA
S1	Signal input for STO function channel 1	<u>S1-DCM / S2-DCM</u> Rated input voltage: +24 V _{DC} \pm 10%; maximum input voltage: +30 V _{DC} Rated input current: 6.67 mA \pm 10%
S2	Signal input for STO function channel 2	<u>STO activation mode</u> Input voltage level: 0 V _{DC} < S1-DCM and S2-DCM < 5 V _{DC} STO response time: \leq 20 ms (time required for S1 / S2 to operate until the drive stops outputting)
DCM	Reference ground for S1 and S2 signal	<u>STO cut-off mode</u> Input voltage level: 11 V _{DC} < S1-DCM and S2-DCM < 30 V _{DC}

Table 1: STO terminal function description

Table 2 describes the action logic and keypad display after the S1 / S2 signal input.

Signal	Status			
	S1-DCM	ON	ON	OFF
S2-DCM	ON	OFF	ON	OFF
Drive output	Ready to output	STL2 mode (torque output off)	STL1 mode (torque output off)	STO mode (torque output off)
Error displayed on keypad	No error displayed	STL2	STL1	STO

Table 2: Action logic and keypad display description

- 📖 STO means channel 1 and 2 operate simultaneously and enter Safe Torque Off.
- 📖 STL1 means channel 1 operates.
- 📖 STL2 means channel 2 operates.
- 📖 STL3 means there is an error detected in the internal loop of channel 1 or channel 2.
- 📖 S1-DCM / S2-DCM ON: means S1-DCM / S2-DCM inputs a power supply > 11 V_{DC}.
- 📖 S1-DCM / S2-DCM OFF: means S1-DCM / S2-DCM inputs a power supply < 5 V_{DC}.

15-3 Wiring Diagram

- 15-3-1. Figure 2 shows the internal circuit diagram of the safe control loop.
- 15-3-2. The terminals of the safe control loop +24V-S1-S2 are short-circuited together with jumper wire at the factory, as shown in Figure 2.
- 15-3-3. The safe control loop wiring diagram is as follows:
 1. Remove the jumper wire from +24V-S1-S2.
 2. The wiring is shown in Figure 3 below. Normally, you must close the ESTOP contact switch, so the drive can output without displaying an error.
 3. In STO mode, the switch ESTOP is turned on. The drive stops outputting and the keypad displays STO.

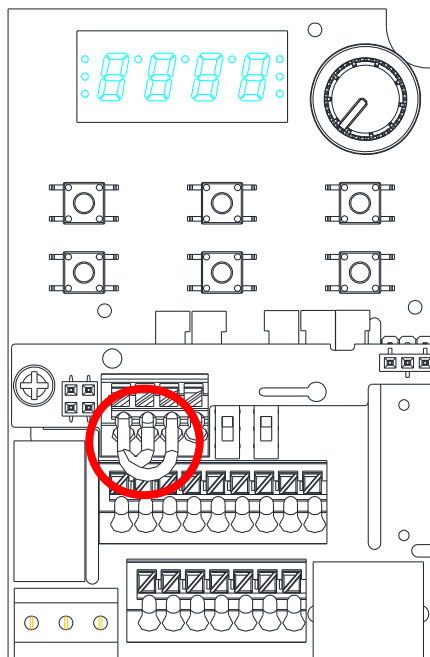

Figure 2

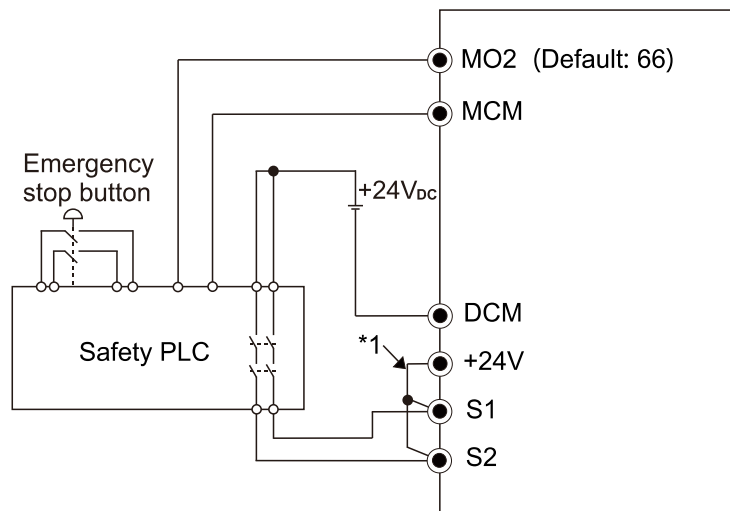

Figure 3

NOTE

*1 is factory jumper wire shorting +24V-S1-S2. To use the Safety function, remove this jumper wire. To disable the Safety function, short-circuit +24V-S1-S2 with a jumper wire.

15-4 Failure Rate of the Drive Safety Function

Refer to Table 3 for the relevant safe loop parameters.

Item	Definition	Standard	Performance
SFF	Safe failure fraction	IEC61508	S1-DCM = 88.35% S2-DCM = 88.2%
HFT (Type A subsystem)	Hardware fault tolerance	IEC61508	1
SIL	Safety integrity level	IEC61508	SIL 2
		IEC62061	SILCL 2
PFH	Average frequency of dangerous failure [h ⁻¹]	IEC61508	1.36 x 10 ⁻⁹
PFD _{av}	Probability of dangerous failure on demand	IEC61508	5.99 x 10 ⁻⁶
PTI	Proof test interval	IEC61508	1 year
Category	Category	ISO13849-1	Category 3
PL	Performance level	ISO13849-1	d
MTTF _d	Mean time to dangerous failure	ISO13849-1	High
DC	Diagnostic coverage	ISO13849-1	Low

Table 3: Relevant safe loop parameters

15-5 Reset the Parameter Settings

Use Pr.06-44 to specify the reset method when an STO alarm occurs.

↗ **06-44** STO Latch Selection

Default: 0

Settings 0: STO Latch
1: STO no Latch

- 📖 Pr.06-44 = 0: STO Alarm Latch. After you clear the cause of the STO Alarm, use a Reset command to clear the STO Alarm.
- 📖 Pr.06-44 = 1: STO Alarm no Latch. After you clear the cause of the STO Alarm, the STO Alarm clears automatically.
- 📖 All of the STL1–STL3 errors are “Alarm Latch” mode (in STL1–STL3 mode, the Pr.06-44 function is not effective).

15-6 Timing Diagram Description

The following timing diagrams show the status of relevant signals under different conditions.

15-6-1 Normal operation status

As shown in Figure 4, when S1-DCM and S2-DCM is ON (STO function is not required), the drive executes Operating or Output Stop according to RUN command.

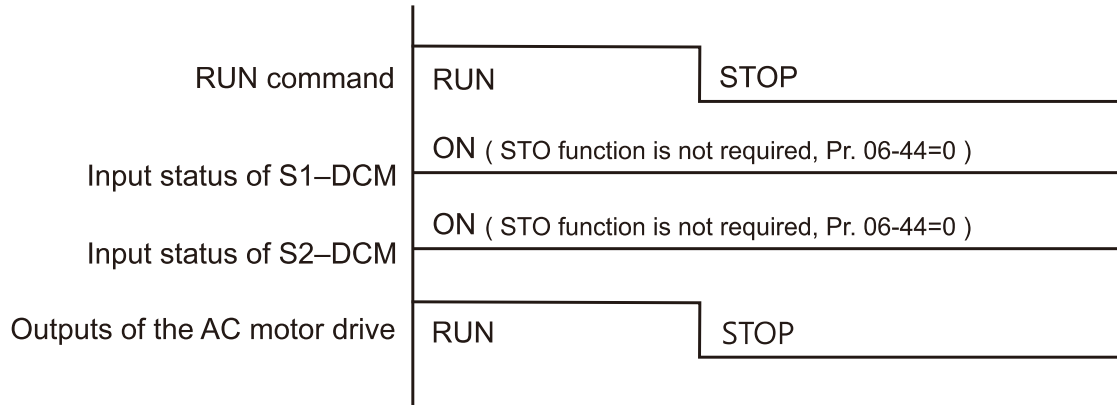

Figure 4

15-6-2-1 STO, Pr.06-44 = 0, Pr.02-35=0 (external control operation after reset / power on, 0=not valid)

As shown in Figure 5, when both S1-DCM and S2-DCM are OFF during operation (STO function is required), the drive stops outputting when it enters safe mode regardless of whether the RUN command is in ON or OFF status.

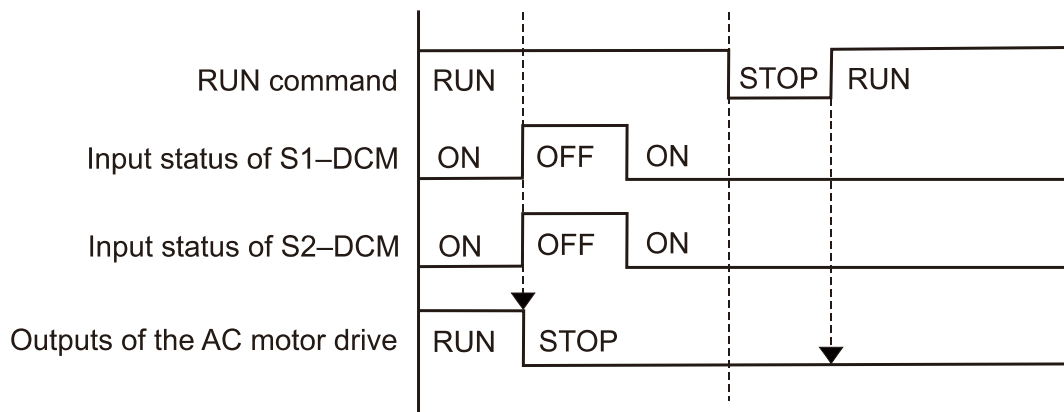

Figure 5

15-6-2-2 STO, Pr.06-44=0, Pr.02-35=1 (external control operation after reset / power on, 1= the drive executes RUN if the command remains after reset)

As shown in Figure 6, the action is the same as in Figure 5; however, because Pr.02-35=1, if the RUN command remains after reset, the drive immediately executes the RUN command again.

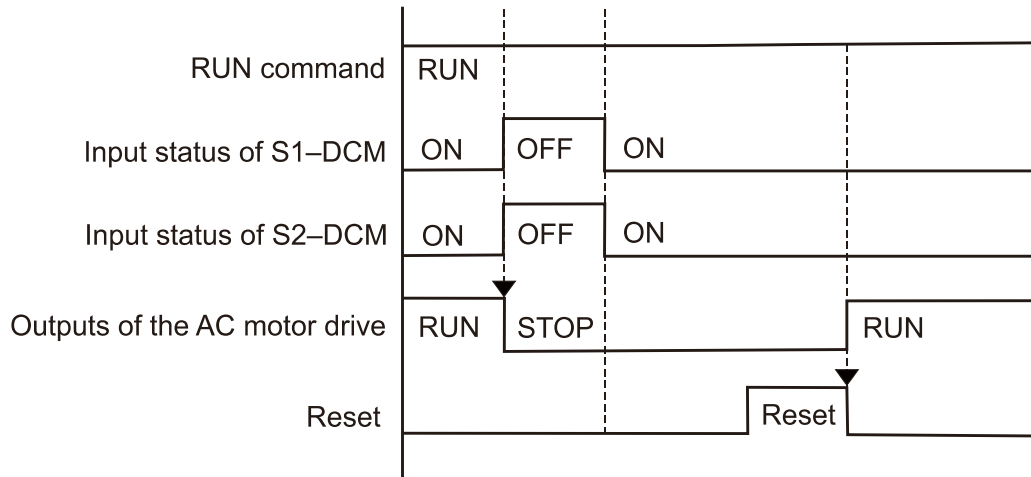

Figure 6

15-6-3 STO, Pr.06-44=1

As shown in Figure 7, when both of S1-DCM and S2-DCM are OFF during operation (STO function is required), the drive stops outputting. When the S1 / S2 status is restored (ON), the STO alarm clears automatically. The drive outputs when the RUN command is executed again.

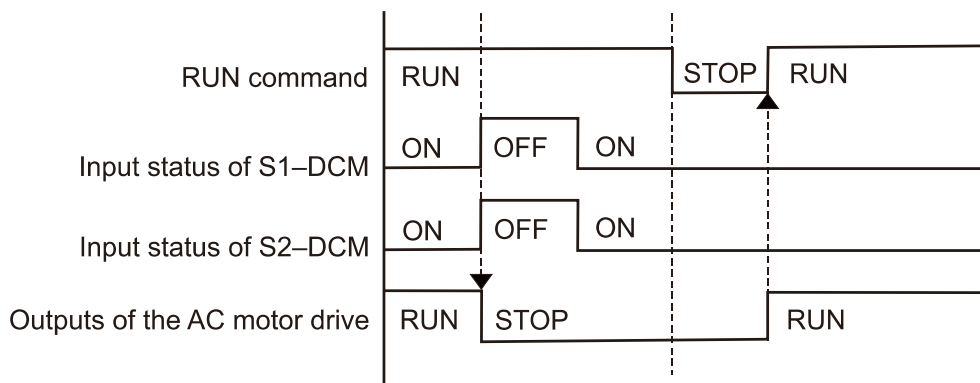

Figure 7

15-6-4 STL1, Pr.06-44=0 or 1

As shown in Figure 8, when S1-DCM is OFF during operation (STO function is required) and S2-DCM is ON (STO function is not required), the drive stops outputting and the keypad shows the STL1 error. However, you cannot reset the STL1 error even if the S1 status is restored (ON) regardless of the parameter setting. You must cycle the power to reset and to restore the drive to the normal standby state.

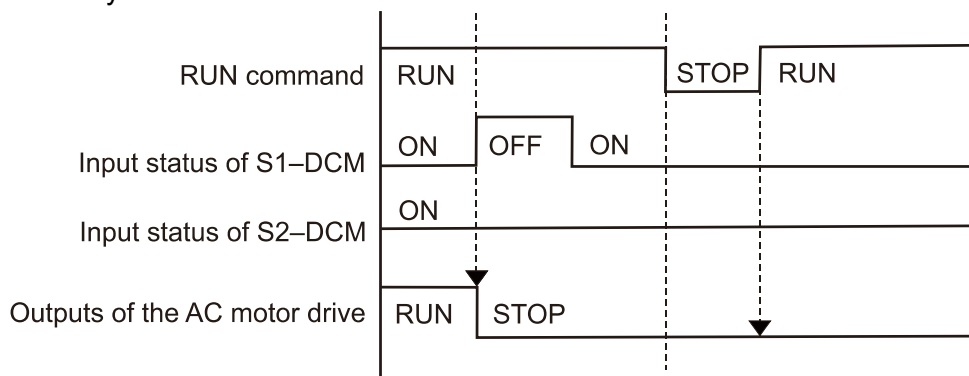

Figure 8

15-6-5 STL2, Pr.06-44=0 or 1

As shown in Figure 9, when S1-DCM is ON during operation (STO function is not required) and S2-DCM is OFF (STO function is required), the drive stops outputting and the keypad shows the STL2 error. However, you cannot reset the STL2 error even if the S2 status is restored (ON) regardless of the parameter setting. You must cycle the power to reset and to restore the drive to the normal standby state.

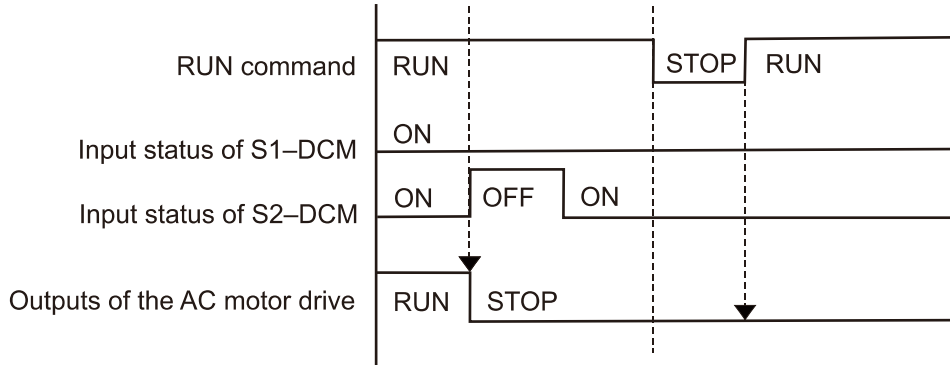

Figure 9

15-7 Error Code and Troubleshooting Instructions

15-7-1 Error Code Description

Refer to Pr.06-17–Pr.06-22 for the fault record; the relevant STO error code is 72/76/77/78. The definition is as follows and in Table 4.

06-17	Fault Record 1
06-18	Fault Record 2
06-19	Fault Record 3
06-20	Fault Record 4
06-21	Fault Record 5
06-22	Fault Record 6

Settings

72: Channel 1 (S1–DCM) safety loop error (STL1)

76: Safe Torque Off (STo)

77: Channel 2 (S2–DCM) safety loop error (STL2)

78: Internal loop error (STL3)

Error code	Name	Description
76 (STO)	Safe Torque Off	Safe Torque Off function active
72 (STL1)	Channel 1 (S1–DCM) safety loop error	S1–DCM internal loop detection error
77 (STL2)	Channel 2 (S2–DCM) safety loop error	S2–DCM internal loop detection error
78 (STL3)	Internal loop error	S1–DCM and S2–DCM internal loop detection error

Table 4: Error code description

15-7-2 Troubleshooting Instructions

Refer to the following instructions for troubleshooting when STO / STL1 / STL2 / STL3 appears on the keypad. Refer to Chapter 14 Error Codes.

ID No.	Digital keypad Display	Descriptions
72	STL1	<p>S1–DCM internal loop detection error</p> <p>Corrective Actions</p> <ul style="list-style-type: none"> ■ Check the wiring of the S1 terminal. ■ Reset the emergency switch (ON: activated) and cycle the power. ■ Check that the input voltage maintains at least 11 V. ■ Check the wiring of the S1 and +24 V terminals. ■ After you make sure all the wiring is correct, if STL1 fault still exists after cycling the power, please contact Delta.
76	STO	<p>Safe Torque Off function active</p> <p>Corrective Actions</p> <ul style="list-style-type: none"> ■ Check the wiring of the S1 and S2 terminals. ■ Reset the emergency switch (ON: activated) and cycle the power. ■ Check that the input voltage maintains at least 11 V. ■ Check the wiring of the S1 / S2 and +24 V terminals. ■ After you make sure all the wiring is correct, if STO fault still exists after cycling the power, please contact Delta.
77	STL2	<p>S2–DCM internal loop detection error</p> <p>Corrective Actions</p> <ul style="list-style-type: none"> ■ Check the wiring of the S2 terminal. ■ Reset the emergency switch (ON: activated) and cycle the power. ■ Check that the input voltage maintains at least 11 V. ■ Check the wiring of the S2 and +24 V terminals. ■ After you make sure all the wiring is correct, if STL2 fault still exists after cycling the power, please contact Delta.
78	STL3	<p>S1–DCM & S2–DCM internal loop detection error</p> <p>Corrective Actions</p> <ul style="list-style-type: none"> ■ After you make sure all the wiring is correct, if STL3 fault still exists after cycling the power, please contact Delta.

Table 5: Digital keypad troubleshooting instructions

15-8 Test and Fault Confirmation

After wiring the STO circuit in accordance with Section 15-3 Wiring Diagram, follow the steps below to verify that the STO and related detection functions are working normally.

1. When the drive is powered on, make sure that the S1–DCM and S2–DCM voltage falls between 11–30 V_{DC}. At this time, the drive should enter Standby mode and wait for RUN command. There is no error displayed on the keypad.
2. Press RUN on the keypad and use the emergency button or other method to make the S1–DCM and S2–DCM voltage fall between 0–5 V_{DC}. At the same time, after the output frequency is reached, the drive should enter Torque Stop mode STO and stop outputting voltage. The keypad displays the STO error, and the response time of the S1 and S2 signals to cause the drive to stop outputting voltage should be ≤ 20 ms. Then restore the S1–DCM and S2–DCM voltage to 11–30 V_{DC}, and press RESET on the keypad to clear the STO error. The drive should enter Standby mode and wait for RUN command.
3. Press RUN on the keypad and use the emergency button or other method to make the S1–DCM voltage fall between 0–5 V_{DC}, and the S2–DCM voltage remain between 11–30 V_{DC} after the output frequency is reached. At this time, the drive should enter Torque Stop mode STL1 and stop outputting voltage. The keypad displays the ST1 error, and the response time of S1 signals to cause the drive to stop outputting voltage should be ≤ 20 ms. Then restore the S1–DCM voltage to 11–30 V_{DC}. However, pressing RESET on the keypad cannot clear the STL1 error. You must cycle the power to the drive. Make sure that the S1–DCM and S2–DCM voltage falls between 11–30 V_{DC}, and then cycle the power to the drive, then the STL1 error is cleared. The drive should enter Standby mode and wait for RUN command.
4. Press RUN on the keypad and use the emergency button or other method to make the S2–DCM voltage fall between 0–5 V_{DC}, and the S1–DCM voltage remain between 11–30 V_{DC} after the output frequency is reached. At this time, the drive should enter Torque Stop mode STL2 and stop outputting voltage. The keypad displays the ST2 error, and the response time of S2 signals to cause the drive to stop outputting voltage should be ≤ 20 ms. Then restore the S2–DCM voltage to 11–30 V_{DC}. However, pressing RESET on the keypad cannot clear the STL2 error. You must cycle the power to the drive. Make sure that the S1–DCM and S2–DCM voltage falls between 11–30 V_{DC}, and then cycle the power to the drive, then the STL2 error is cleared. The drive should enter Standby mode and wait for RUN command.
5. If you can conduct these four steps normally in sequence with no other error, then the Safe Torque Off function loop is normal, as shown in Table 6 below. However, if a situation that differs from these four steps, or if STL3 occurs, then the Safe Torque Off function loop is not working normally. Please refer to Section 15-7 Error Code and Troubleshooting Instructions.

Signal	Status			
S1-DCM	ON	ON	OFF	OFF
S2-DCM	ON	OFF	ON	OFF
Drive output	Ready to output	STL2 mode (torque output off)	STL1 mode (torque output off)	STO mode (torque output off)
Error displayed on keypad	No error displayed	STL2	STL1	STO
Response time	N/A	≤ 20 ms		
RESET mechanism	N/A	Cycle power to the drive	Cycle power to the drive	Press RESET directly

Table 6: Action logic and keypad display description

- 📖 STO means channel 1 and 2 operate simultaneously and enter Safe Torque Off.
- 📖 STL1 means channel 1 operates.
- 📖 STL2 means channel 2 operates.
- 📖 STL3 means there is an error detected in the internal loop of channel 1 or channel 2.
- 📖 S1-DCM / S2-DCM ON: means S1-DCM / S2-DCM inputs a power supply > 11 V_{DC}.
- 📖 S1-DCM / S2-DCM OFF: means S1-DCM / S2-DCM inputs a power supply < 5 V_{DC}.